



METRICA

MADE TO MEASURE



CATALOGO GENERALE



METRICA
MADE TO MEASURE





/mi-şu-rà-re/: Determinare il valore di una grandezza fisica con l'impiego di uno strumento di misura e in riferimento a una unità di misura.

La Nostra Storia

1949

Nell'immediato dopoguerra, a Danta, un piccolo paese a 1400 m di altezza nel cuore delle Dolomiti, ha inizio l'attività di Metrica. Pochi operai riuniti attorno al Fondatore, l'ing. Sergio Doriguzzi Bozzo, iniziano la produzione di metri e calibri.

1955

Metrica inizia a svilupparsi rapidamente, grazie al fermento economico legato alla ripresa della produzione industriale ed alla ricostruzione. Nasce il nuovo sito produttivo di Arzignano e si amplia la gamma di prodotti: livelle, squadre, livelle, misuratori di spessore, micrometri, alessametri e comparatori fanno la loro comparsa nel catalogo Metrica.

1964

Grazie al figlio di Sergio, l'ing. Mario Doriguzzi, ancora oggi Presidente di Metrica, si inizia a guardare ad uno sviluppo internazionale e per questo nasce la sede commerciale di Milano, ormai punto nevralgico del rinato tessuto industriale italiano. Nel frattempo Metrica afferma progressivamente la propria presenza su tutto il territorio nazionale.

1975

Continua lo sviluppo commerciale dell'azienda. La gamma prodotti si amplia progressivamente per far fronte alle continue richieste del mercato, che ormai vede in Metrica un punto di riferimento. Nasce la nuova sede di Via Pergolesi a Milano.

1990

L'innovazione di prodotto continua a distinguere Metrica dalla concorrenza. L'Azienda sviluppa ed introduce tra i primi la tecnologia dei livelli a laser a pendolo, pionieri degli attuali autolivelli laser, strumenti in grado di semplificare in modo sostanziale le operazioni di misura, tracciatura e controllo nel campo delle costruzioni edili.

1995

Con la crescita e la necessità di espandersi, giunge al termine la presenza di Metrica all'interno del tessuto urbano milanese. Un nuovo spazio è identificato nella zona di San Donato e nasce la nuova sede di Metrica, ancora oggi headquarter dell'Azienda.

2002

Il cambiamento continua. La terza generazione della famiglia Doriguzzi Bozzo, rappresentata da Margherita Doriguzzi Bozzo, nipote del Fondatore, entra in azienda ed inizia a definire le strategie per affrontare le sfide del mercato globale e competere nel nascente contesto digitale

2015

Per soddisfare le esigenze di tempestività del mercato, Metrica installa, nella propria nuova sede di San Donato Milanese, un magazzino automatizzato capace di gestire più di 3.000 pallet ed assicurare puntualità e prontezza di evasione degli ordini.

2018

Anche il 2018 è segnato da innovazione e sviluppo tecnologico. Nasce la nuova gamma di distanziometri Metrica FLASH, ultimi risultati di quel lungo processo di ricerca nato negli anni '90 e che guardano ad un mercato altamente diversificato, dove le esigenze del pubblico professionale si mischiano alle necessità dei nuovi target di utilizzatori.

2021 MADE TO CUSTOM

la maggior parte dei prodotti Metrica sono personalizzabili con il logo cliente su richiesta. Per maggiori informazioni non esitate a contattarci a info@metrica.it o visitate il sito METRICA.IT sezione "crea il tuo prodotto"

Misurare è scritto nel DNA di Metrica.

Da oltre settant'anni produciamo strumenti di misurazione per qualsiasi "dimensione" nei settori della meccanica, edilizia ed utensileria

Nel corso della nostra evoluzione abbiamo fatto della ricerca della precisione nella misurazione un valore fondamentale.

Numerosi sono, infatti, i brevetti sviluppati dallo Staff Tecnico Metrica.

I Telefix (misuratori telescopici fino a 10m) ed i Quadranfix (misuratori d'angolo per edilizia), così come molte innovazioni introdotte su flessometri con magneti fissi, metri a stecca o livelle, rappresentano solo alcune delle tecnologie che hanno fatto di Metrica un punto di riferimento per la misura ed il controllo.

Obiettivo principale della nostra ricerca è da settant'anni il servizio al Cliente: innoviamo costantemente i nostri strumenti, perché vogliamo rendere il lavoro più semplice, veloce e preciso.

Oggi Metrica è presente a livello globale, rappresentata in oltre 30 Paesi attraverso una capillare rete di agenti e distributori con una gamma di prodotti in grado di soddisfare tutte le esigenze di misurazione.

Metrica. Made. To measure.

METRICA
MADE TO MEASURE

I Valori Metrica

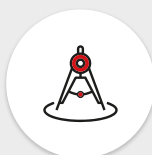

Precisione



Innovazione



Qualità

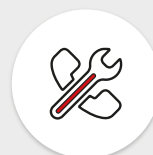

Servizio



Made to measure
(= customizzazione)

CONDIZIONI GENERALI DI VENDITA:

IMPORTO MINIMO DI FORNITURA: EURO 155.

Per forniture di importo inferiore addebito fisso di EURO 5 per contributo spese gestione

RESA: franco San Donato Milanese

IMBALLO: al costo

PAGAMENTO: anticipato o contrassegno (con ns. vettore convenzionato) per campionatura o prima fornitura - da concordare per forniture successive.

TRASPORTO: franco nostro magazzino per ordini d'imponibile merce inferiore ad EURO 500 - franco magazzino cliente per ordini d'imponibile merce superiore ad EURO 500 con ns. vettore

PREZZI: SI INTENDONO IVA ESCLUSA.

Dove non indicato il prezzo, ma (*), è da intendersi prezzo a richiesta.

MODALITÀ DEI RESI:

Il reso di merce, da accreditare, da sostituire o da ripartire, DEVE ESSERE AUTORIZZATO DAL NOSTRO UFFICIO COMMERCIALE. Il materiale deve essere spedito, corredato da regolare documento di trasporto, presso il nostro indirizzo di San Donato Milanese (MI) - Via Achille Grandi 18 - USANDO UNICAMENTE IL NOSTRO CORRIERE CONVENZIONATO, che solo dietro nostra disposizione scritta effettuerà il ritiro dei materiali presso di Voi. Ogni documento di trasporto deve riportare chiaramente la causale del reso e obbligatoriamente gli estremi della nostra fattura di vendita.

TABELLA COSTI

METRI, FLESSOMETRI, ROTELLE E MISURE LINEARI SONO SOGGETTI AD ATTESTAZIONE DI CONFORMITÀ

In base alle vigenti normative la prova della rispondenza alla normativa applicabile è data dalla marcatura 

I costi esposti in tabella sono riferiti alle differenti lunghezze delle misure lineari.

Descrizione		Descrizione		Descrizione	
1 metro	€ 0,05	8 metri	€ 0,10	30 metri	€ 0,15
2 metri	€ 0,05	10 metri	€ 0,10	50 metri	€ 0,15
3 metri	€ 0,10	15 metri	€ 0,15	oltre 50 metri	€ 0,15
5 metri	€ 0,10	20 metri	€ 0,15		

Anno di stampa: 2021

Nel corso di validità del presente catalogo, i prodotti potrebbero subire modifiche, rispetto alle immagini proposte, che non ne compromettono l'utilizzo o le caratteristiche tecniche.

Metrica si riserva la facoltà di apportare modifiche senza obbligo di preavviso.



AUTOLIVELLI LASER	Pag. 6
ACCESSORI LASER	Pag. 30
TREPIEDI	Pag. 42
GEODESIA	Pag. 45
DISTANZIOMETRI LASER	Pag. 48
TERMOCAMERE	Pag. 67
MISURATORI DUREZZA, SCLEROMETRO	Pag. 77
MISURATORI	Pag. 78
MISURATORI STRADALI	Pag. 82
FESSURIMETRI	Pag. 84
MISURATORI D'ANGOLO	Pag. 85
TELEFIX	Pag. 88
PALINE	Pag. 91











FLESSOMETRI PROFESSIONALI	Pag. 92
ROTELLE	Pag. 112
METRI A STECCA E PER SARTO	Pag. 125
FINGERSAFE	Pag. 141
GONIOMETRI	Pag. 142
SQUADRE	Pag. 143
LIVELLE PER EDILIZIA	Pag. 147
STAGGIE	Pag. 164
CUTTER	Pag. 165
RIGHE E SQUADRE PER VETRAI	Pag. 175
FORBICI E CESOIE	Pag. 177
CONTAFILI E LENTI	Pag. 180
GESSI, PASTELLI E MATITE	Pag. 181
MARCATORI SPRAY E MARCATORI	Pag. 187
PIOMBI	Pag. 192
CORDE E COLORANTI	Pag. 193
TRACCIATORI	Pag. 194
ACCESSORI PER EDILIZIA	Pag. 196



CALIBRI	Pag. 197
MICROMETRI	Pag. 218
COMPARATORI	Pag. 226
ALESAMETRI	Pag. 229
MISURATORI DI SPESSORE	Pag. 231
RIGHE - NASTRI - DIAMETROMETRI	Pag. 234
SQUADRE PRECISIONE	Pag. 243
PROFILOMETRI	Pag. 245
COMPASSI	Pag. 246
PUNTE A TRACCIARE	Pag. 248
TRUSCHINI	Pag. 249
LIVELLE PRECISIONE	Pag. 250
PIANI RISCONTRO	Pag. 251
PRISMI - GUARDAPIANO	Pag. 252
BASI MAGNETICHE	Pag. 253
SUPPORTI	Pag. 254
PUNZONI	Pag. 255
CONTATORI E CONTACOLPI	Pag. 256

			USO IN = interno OUT = esterno	IP IMPERMEABILITÀ	COLORE LASER ● = Rosso ● = Verde	CROCE FISSA	PUNTI AUTOLIVELLATI	CROCE AUTOLIVELLATA	PIOMBO	SQUADRO	LINEA ORIZZONTALE COMPLETA SU 360°	BATTERIE RICARICABILI
BRAVO LASER BOX		Ref. 61300 pag. 8	IN	IP 43	●	●		●				
BRAVO LASER BOX2		Ref. 60804 pag. 9	IN/OUT	IP 54	●	●		●				
BRAVO LASER 180		Ref. 60805 pag. 10	IN/OUT	IP 54	●	●		●				
BRAVO LASER CR5D 2.0 GREEN		Ref. 61360 Ref. 61365 pag. 11	IN/OUT	IP 54	● ●	●	5	●	●			
BRAVO LASER BOX 3 BOX 3 GREEN		Ref. 61420 Ref. 61430 pag. 12	IN		● ●			●			●	LI-ION
BRAVO LASER FLASH GREEN 360°		Ref. 61435 pag. 13	IN/OUT	IP 54	●	●		●			●	LI-ION
BRAVO LASER 360°+1V GREEN		Ref. 61370 Ref. 61375 pag. 14	IN/OUT	IP 54	● ●	●	2	●	●		●	
BRAVO LASER 360°+2V GREEN		Ref. 60814BR Ref. 61380 pag. 15	IN/OUT	IP 54	● ●	●	1	●	●	1	●	
METRICA 3D GREEN		Ref. 61400M Ref. 61410M pag. 16	IN/OUT	IP 54	● ●	●		●	●	4	●	LI-ION
METRICA 3D JUNIOR GREEN		Ref. 61405M Ref. 61415M pag. 17	IN/OUT	IP 54	● ●	●		●	●	4	●	LI-ION
BRAVO LASER XXL		Ref. 60807 pag. 18	IN/OUT	IP 54	●	●		●	●	4	●	

			USO IN = interno OUT = esterno	IP IMPERMEABILITÀ	COLORE LASER ● = Rosso ● = Verde	PIOMBO	LINEA ORIZZONTALE COMPLETA SU 360°	ROTATIVO ORIZZONTALE	ROTATIVO VERTICALE	CAMPO DI REGOLAZIONE PENDENZA ±10%	TILT	SCANNER	BATTERIE RICARICABILI
BRAVO LASER ROTATIVO H		Ref. 60719BM pag. 19	IN/OUT	IP 54	●		●	●			●		NI-MH
BRAVO LASER ROTATIVO H		Ref. 60719 pag. 20	IN/OUT	IP 64	●		●	●			●	●	NI-MH
BRAVO LASER ROTATIVO HV		Ref. 61355 pag. 21	IN/OUT	IP 66	●	●	●	●	●		●	●	NI-MH
BRAVO LASER ROTATIVO SL-RED		Ref. 60821 pag. 22	IN/OUT	IP 54	●	●	●	●	●		●	●	NI-MH
BRAVO LASER ROTATIVO SL-GREEN		Ref. 60822 pag. 23	IN/OUT	IP 54	●	●	●	●	●		●	●	NI-MH
BRAVO LASER ROTATIVO HV4		Ref. 61350 pag. 24	IN/OUT	IP 64	●	●	●	●	●		●	●	NI-MH
BRAVO LASER ROTATIVO HV4		Ref. 61352 pag. 25	IN/OUT	IP 64	●	●	●	●	●		●	●	NI-MH
KIT		Ref. 61349 Ref. 61351 Ref. 61353 Ref. 61354 pag. 26-27	IN/OUT	IP 64	●	●	●	●	●		●	●	NI-MH
BRAVO LASER ROTATIVO INCLIGRAD 2		Ref. 61345 pag. 28	IN/OUT	IP 54	●	●	●	●	●	●	●	●	NI-MH

**BRAVO
LASER
BOX**

AUTOLIVELLO LASERBOX

Ref.			€
61300	8001066613007	1	-



- Autolivello laser: proietta un **piano verticale e/o uno orizzontale a croce fissa o autolivellata per uso interno**
- Lampeggio automatico del laser se il dispositivo è fuori dal campo di autolivellamento
- Forma compatta, rivestimento in gomma antiscivolo ed antiurto



IN CUSTODIA



Ref. 60713
INCLUSO



SUPPORTO
A MOLLA
Ref. 60816
INCLUSO



CARATTERISTICHE TECNICHE

Portata (secondo luminosità ambientale)	10 m
Precisione di livellamento	± 2 mm / 5 m
Campo di autolivellamento	± 4°
Segnale di fuori livellamento	lampeggio luminoso
Tipo di laser	635 nm
Potenza laser	Classe II
Batterie (incluse)	2 X 1.5V AA alkaline
Dimensione (mm)	82 x 57 x 90
Peso (senza batterie)	0,36 kg
Impermeabilità	IP 43
Filetto per attacco treppiedi	1/4"

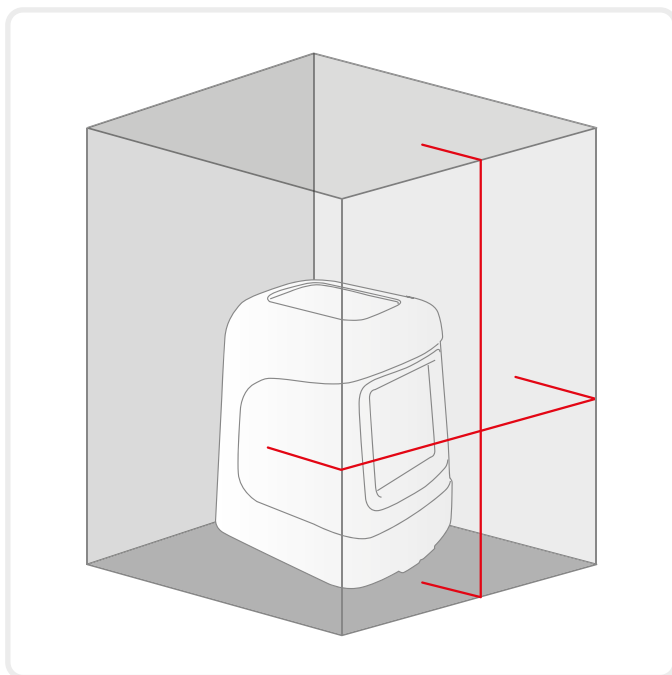

**BRAVO
LASER
BOX2**

AUTOLIVELLO LASERBOX 2 GOMMATO

Ref.			€
60804	8001066608041	1	-

- Autolivello laser: proietta un piano verticale ed uno orizzontale a **croce sia fissa che autolivellata, per uso interno ed esterno**
- Uso interno ed esterno (con ricevitore non incluso)
- Spegnimento automatico del laser se il dispositivo è fuori dal campo di autolivellamento
- Sistema di blocco integrato per evitare le vibrazioni durante il trasporto
- Forma compatta, rivestimento in gomma antiscivolo ed antiurto



IN CUSTODIA



INCLUSO



Ref. 60714M
INCLUSO

CARATTERISTICHE TECNICHE

Portata (secondo luminosità ambientale)	10 ÷ 15 m
Portata con ricevitore	50 m
Precisione di livellamento	± 1 mm / 3 m
Campo di autolivellamento	± 3°
Smorzamento	magnetico
Segnale di fuori livellamento	si
Tipo di laser	635 nm
Potenza laser	classe II
Batterie (incluse)	3 x 1,5 V AA
Dimensione (mm)	100 x 90 x 65
Peso (senza batterie)	0,28 Kg
Impermeabilità	IP 54
Filetto per attacco treppiedi	5/8"

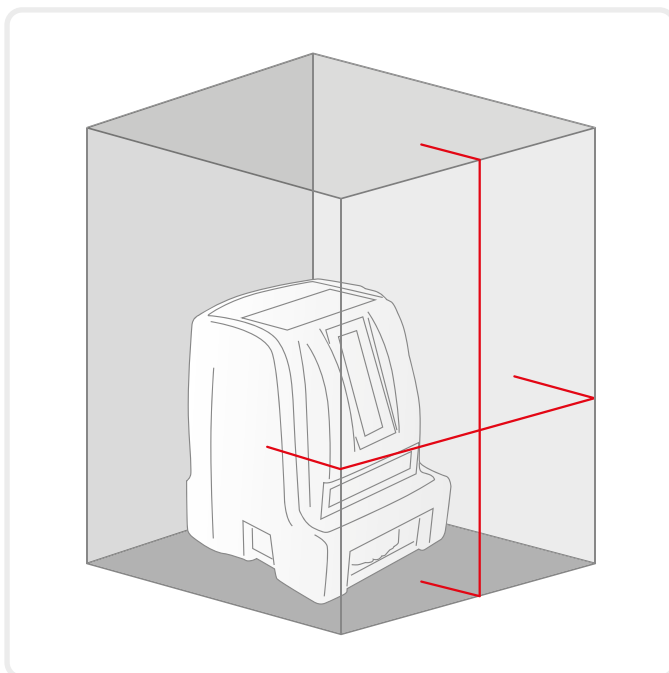

**BRAVO
LASER
180**

LASERBOX 180

Ref.			€
60805	8001066608058	1	-

- Autolivello laser: proietta un piano verticale e orizzontale con **apertura 180° a croce sia fissa che autolivellata**, per uso interno ed esterno
- Uso interno ed esterno (con ricevitore non incluso)
- Spegnimento automatico del laser se il dispositivo è fuori dal campo di autolivellamento
- Sistema di blocco integrato per evitare le vibrazioni durante il trasporto
- Forma compatta, antiscivolo



IN CUSTODIA



INCLUSO

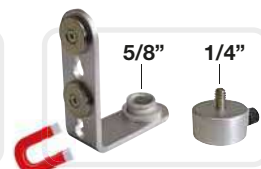

Ref. 60714M
INCLUSO



CARATTERISTICHE TECNICHE

Portata (secondo luminosità ambientale)	10 ÷ 30 m
Portata con ricevitore	50 m
Precisione di livellamento	± 1 mm / 3 m
Campo di autolivellamento	± 3°
Smorzamento	magnetico
Segnale di fuori livellamento	si
Tipo di laser	635 nm
Potenza laser	classe II
Batterie (incluse)	3 x 1,5 V AA
Dimensione (mm)	100 x 90 x 65
Peso (senza batterie)	0,28 Kg
Impermeabilità	IP 54
Filetto per attacco treppiedi	1/4"

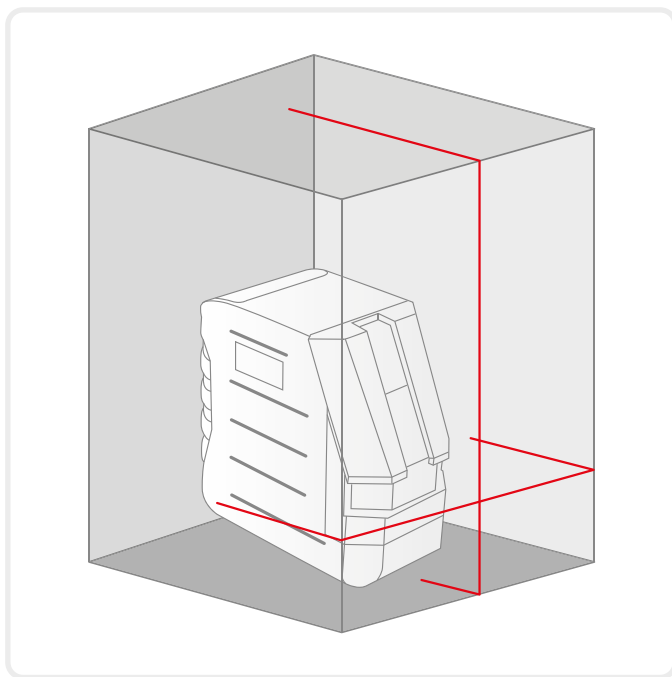

**BRAVO
LASER
CR5D 2.0
GREEN**

AUTOLIVELLO LASER CR + 5 PUNTI

Ref.				€
61360		8001066613601	1	-
61365		8001066613656	1	-



- Autolivello laser tascabile **per uso interno ed esterno** con ricevitore non incluso
- Rivestito in gomma antiscivolo ed antiurto
- Proietta una linea orizzontale e verticale
- Proietta la croce (orizzontale oltre i 180° + verticale) sia fissa che autolivellata
- Proietta 5 punti su piani ortogonali sia fissi che autolivellati**
- Allarme acustico e visivo quando lo strumento è fuori campo di autolivellamento
- Attacco 1/4"



IN VALIGETTA

Ref. 61342
INCLUSO

Ref. 60713
INCLUSO

Ref. 60738
INCLUSO

CARATTERISTICHE TECNICHE

	61360	61365
Portata (secondo luminosità ambientale)	15 ÷ 20 m	25 ÷ 30 m
Portata con ricevitore	50 m	50 m
Precisione di livellamento	± 3 mm / 10 m	± 3 mm / 10 m
Campo di autolivellamento	± 4°	± 4°
Segnale di fuori livellamento	si	si
Tipo di laser	635 nm <1mw	515 nm <1mw
Potenza laser	classe II	classe II
Batterie (incluse)	4 x 1,5 V AA	4 x 1,5 V AA
Dimensione (mm)	110 x 57 x 97	110 x 57 x 97
Peso (senza batterie)	0,4 Kg	0,4 Kg
Impermeabilità	IP 54	IP 54
Filetto per attacco treppiedi	1/4"	1/4"

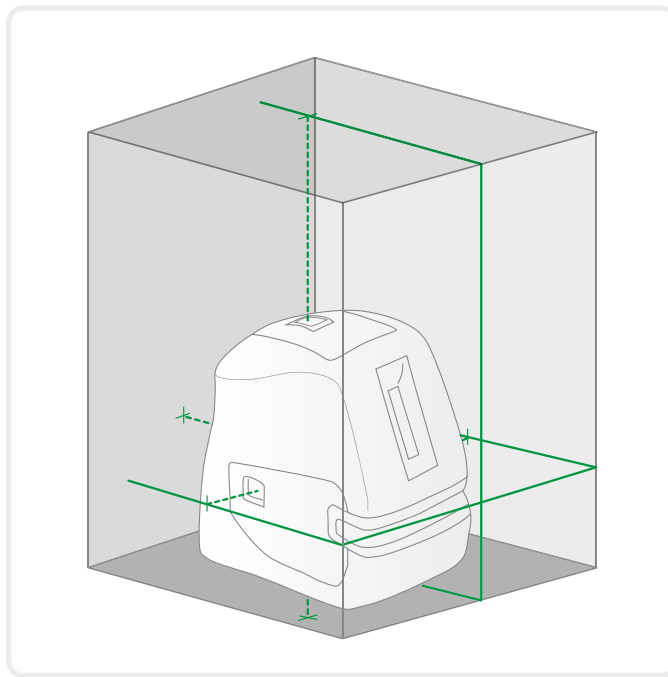
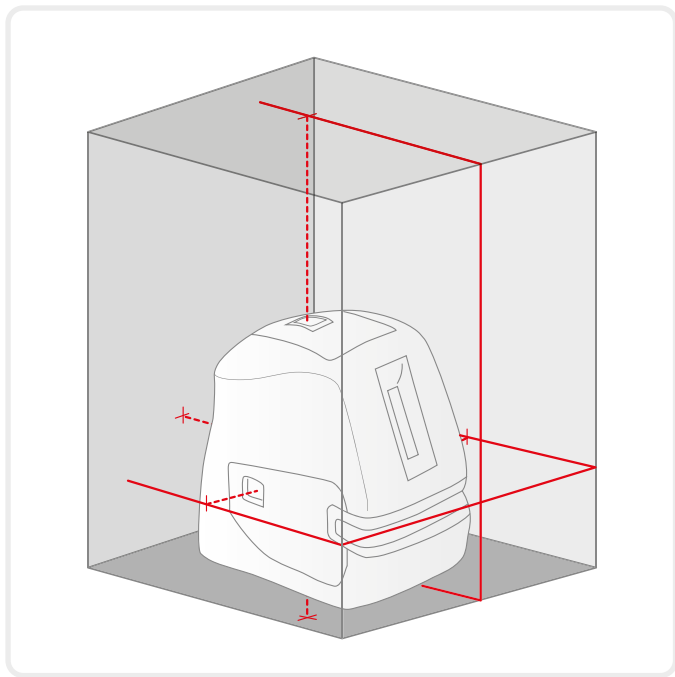

**BRAVO
LASER
BOX 3**

BOX 3 GREEN

AUTOLIVELLO LASERBOX 3 LASERBOX 3 GREEN

Ref.				€
61420		8001066614202	1	-
61430		8001066614301	1	-



- Autolivello laser rosso (Ref. 61420) o verde (Ref. 61430).
Proietta: **un piano orizzontale su 360° più un piano verticale a 90°** formando 1 croce a parete
- Facile posizionamento a filo pavimento (< 1 cm)
- **Uso interno**
- Lampeggio automatico del laser se il dispositivo è fuori dal campo di autolivellamento
- Sistema di blocco integrato per evitare le vibrazioni durante il trasporto
- Forma compatta, rivestimento in gomma antiscivolo ed antiurto
- **Batteria ricaricabile al Li-ion e caricatore/alimentatore 220 V**



IN CUSTODIA



INCLUSO

Batteria ricaricabile Li-ion
+ caricatore/alimentatore 220 V



Ref. 61445
INCLUSO

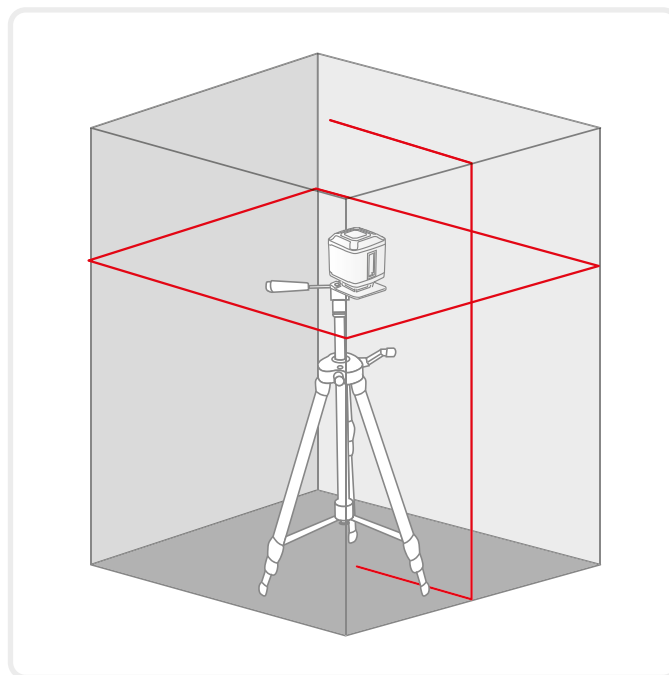
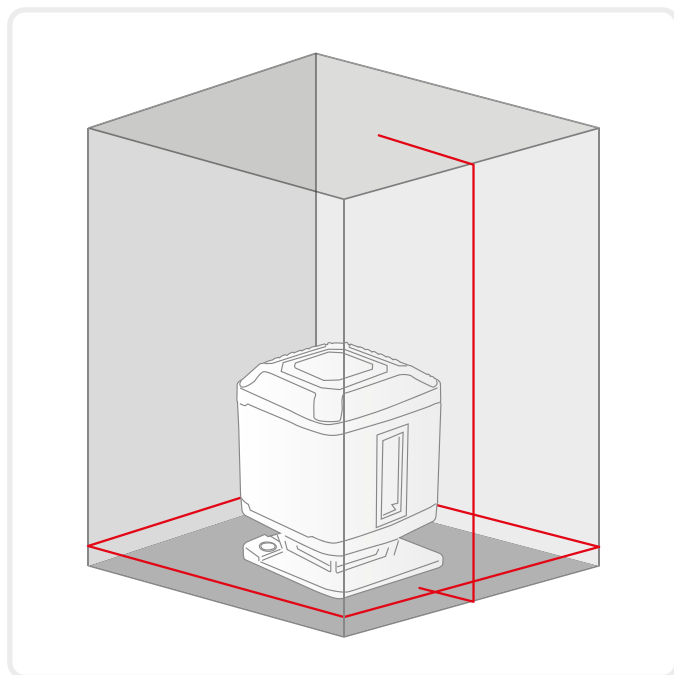

CARATTERISTICHE TECNICHE

	61420	61430
Portata (secondo luminosità ambientale)	20 m	30 m
Precisione di livellamento	± 3 mm / 10 m	± 3 mm / 10 m
Campo di autolivellamento	± 3°	± 3°
Segnale di fuori livellamento	si	si
Tipo di laser	638 nm <1mw	520 nm <1mw
Potenza laser	classe II	classe II
Batterie	3 x 1,5 V AA	3 x 1,5 V AA
Dimensione (mm)	70 x 70 x 90	70 x 70 x 90
Peso (senza batterie)	0,22 Kg	0,22 Kg
Filetto per attacco treppiedi	1/4"	1/4"



**BRAVO
LASER**
FLASH GREEN
360°

FLASH GREEN 360°

Ref.			€
61435	8001066614356	1	-



- **Autolivello laser verde.** Proietta: **un piano orizzontale su 360° più un piano verticale a 90°** formando 1 croce a parete
- Laser con intensità regolabile
- **Usò interno/esterno** (con ricevitore non incluso Ref. 60749)
- Lampeggio automatico del laser se il dispositivo è fuori dal campo di autolivellamento
- Sistema di bloccaggio automatico per evitare vibrazioni durante il trasporto
- Forma compatta, rivestimento in gomma antiscivolo ed antiurto
- Attacco 1/4" per il treppiede
- **Base magnetica e calotta metallica** per facile sovrapposizione
- **Batterie Ion-Li ricaricabili tramite cavetto USB in dotazione**



IN CUSTODIA



INCLUSO



INCLUSO

CARATTERISTICHE TECNICHE

Portata (secondo luminosità ambientale)	40 m
Portata con ricevitore	60 m
Precisione di livellamento	± 3 mm / 10 m
Campo di autolivellamento	± 4°
Segnale di fuori livellamento	si
Tipo di laser	505-550 nm < 1mw
Potenza laser	classe II
Batterie	2000 mAh li-ion
Dimensione (mm)	114 x 66 mm
Peso (senza batterie)	0,275 Kg
Impermeabilità	IP 54
Filetto per attacco treppiedi	1/4"



SOVRAPPONIBILI

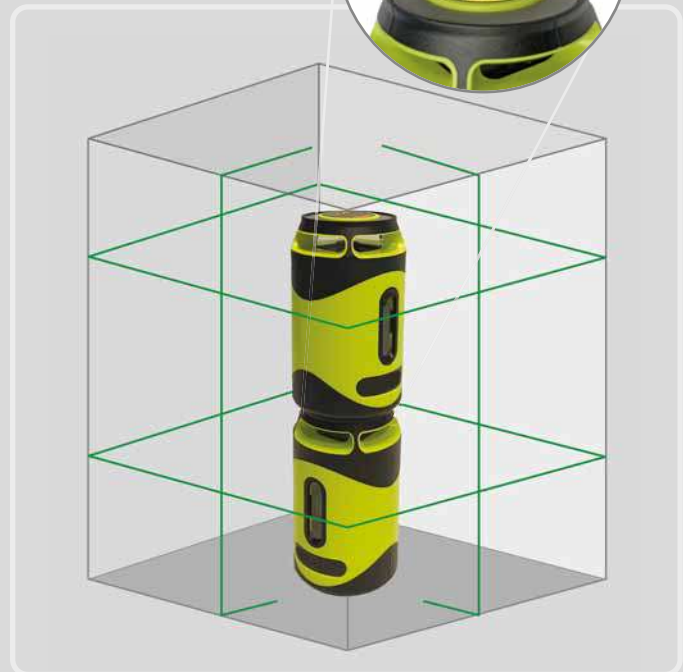
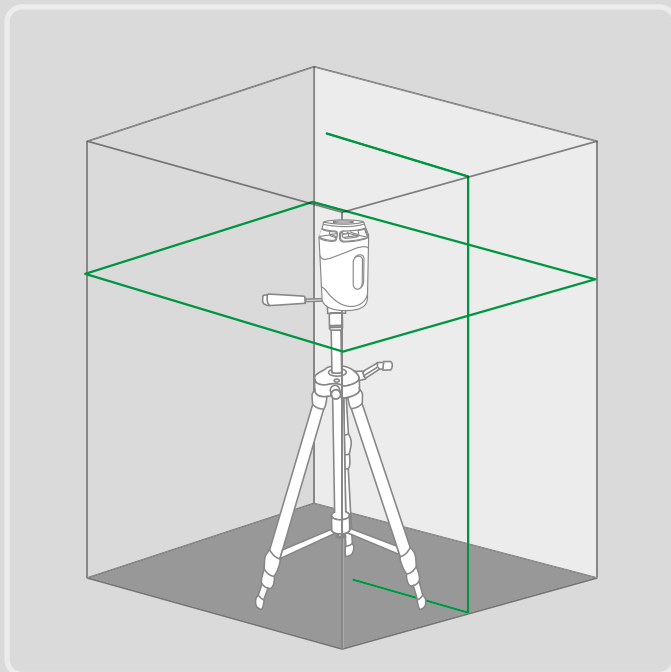

**BRAVO
 LASER**
360°+1V
GREEN

AUTOLIVELLO LASER H360 + 1V + 2D

Ref.				€
61370		8001066613700	1	-
61375		8001066613755	1	-

- Autolivello laser rosso (Ref. **61370**) o verde (Ref. **61375**). Proietta: **un piano orizzontale su 360° più un piano verticale formando 1 croce a parete, più 2 Punti** (terra e soffitto) per il piombo
- Facile posizionamento a filo soffitto (< 2 cm)
- Uso interno ed esterno (con ricevitore non incluso Ref. **60748 rosso/Ref. 60749 verde**)
- Lampeggio automatico del laser se il dispositivo è fuori dal campo di autolivellamento
- Possibilità di proiettare le linee anche in posizione fissa ed inclinata
- Sistema di blocco integrato per evitare le vibrazioni durante il trasporto
- Forma compatta, rivestimento in gomma antiscivolo ed antiurto
- Fornito con supporto magnetico per muratura e cartongessisti in valigetta rigida.



CARATTERISTICHE TECNICHE

	61370	61375
Portata (secondo luminosità ambientale)	15 ÷ 20 m	25 ÷ 30 m
Portata con ricevitore	50 m	50 m
Precisione di livellamento	± 2 mm / 10 m	± 2 mm / 10 m
Campo di autolivellamento	± 4°	± 4°
Segnale di fuori livellamento	si	si
Tipo di laser	635/638/640 <1mw linea/cono/punto	515/640 nm <1mw linea/cono/punto
Potenza laser	classe II	classe II
Batterie (incluse)	4 x 1,5 V AA	4 x 1,5 V AA
Dimensione (mm)	120 x 120 x 80	120 x 120 x 80
Peso (senza batterie)	0,4 Kg	0,4 Kg
Impermeabilità	IP 54	IP 54
Filetto per attacco treppiedi	1/4" - 5/8"	1/4" - 5/8"

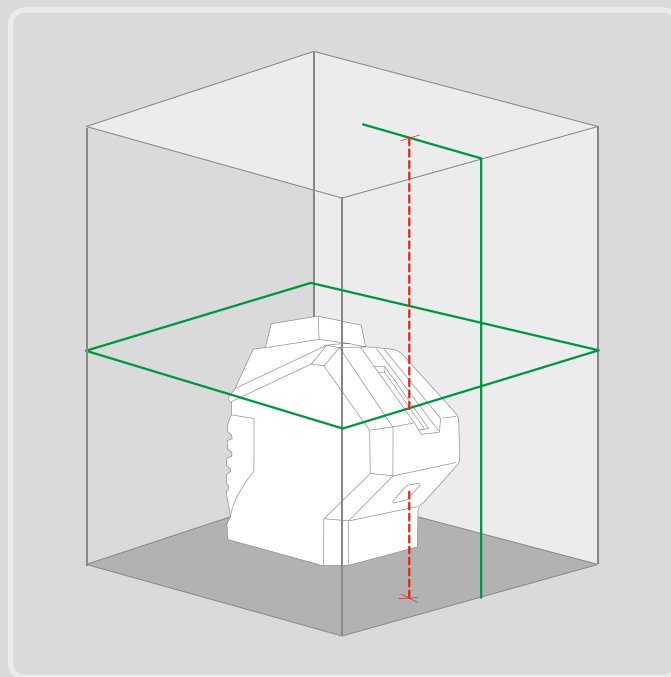
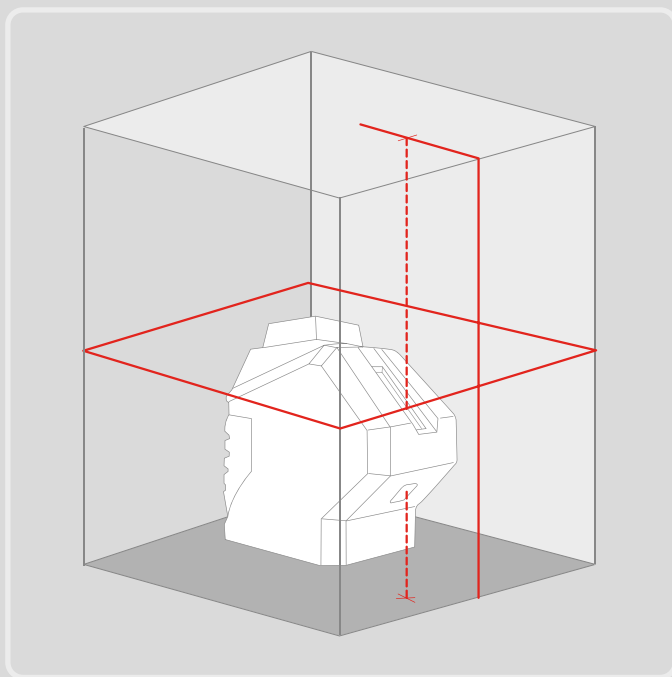

**BRAVO
LASER**
360°+2V
GREEN

AUTOLIVELLO LASER H360 + 2V + 1D

Ref.				€
60814BR	●	8001066608140	1	-
61380	●	8001066613809	1	-

- Autolivello laser rosso (Ref. **60814BR**) o verde (Ref. **61380**). Proietta: **un piano orizzontale su 360° più due piani verticali a 90° tra loro formando 2 croci a parete e il piombo a terra**
- Facile posizionamento a filo soffitto (< 2 cm)
- Usò interno ed esterno (con ricevitore non incluso Ref. **60748** rosso/ Ref. **60749** verde)
- Lampeggio automatico del laser se il dispositivo è fuori dal campo di autolivellamento
- Possibilità di proiettare le linee anche in posizione fissa ed inclinata
- Sistema di blocco integrato per evitare le vibrazioni durante il trasporto
- Forma compatta, rivestimento in gomma antiscivolo ed antiurto
- Fornito con supporto magnetico per muratura e cartongessisti in valigetta rigida.

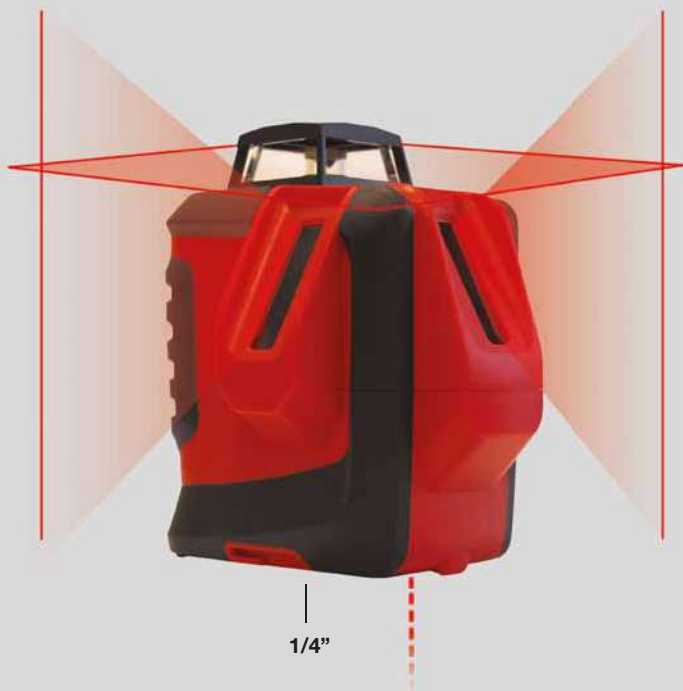

CARATTERISTICHE TECNICHE

	60814BR ●	61380 ●
Portata (secondo luminosità ambientale)	15 ÷ 20 m	25 ÷ 30 m
Portata con ricevitore	50 m	50 m
Precisione di livellamento	± 2 mm / 10 m	± 2 mm / 10 m
Campo di autolivellamento	± 3°	± 3°
Segnale di fuori livellamento	si	si
Tipo di laser	635/638/640 <1mw linea/cono/punto	515/640 nm <1mw linea/cono/punto
Potenza laser	classe II	classe II
Batterie (incluse)	4 x 1,5 V AA	4 x 1,5 V AA
Dimensione (mm)	120 x 120 x 80	120 x 120 x 80
Peso (senza batterie)	0,52 Kg	0,52 Kg
Impermeabilità	IP 54	IP 54
Filetto per attacco treppiedi	1/4"	1/4"

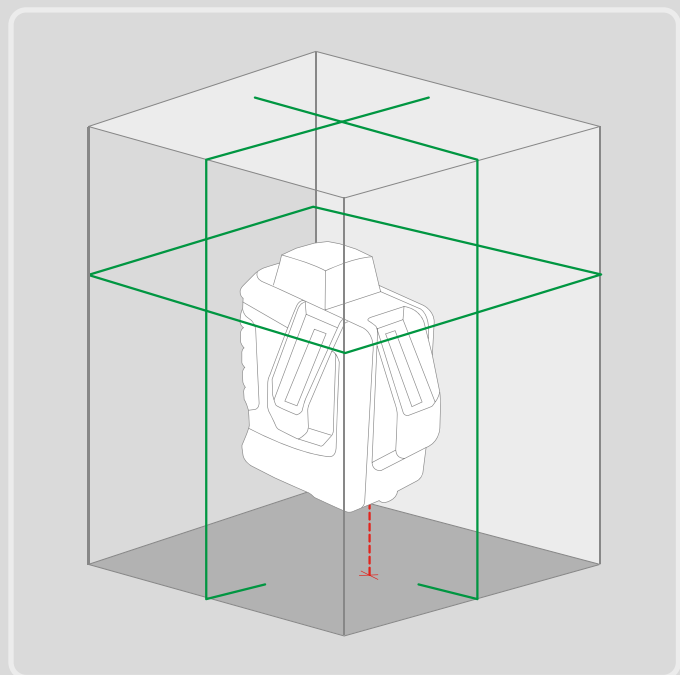
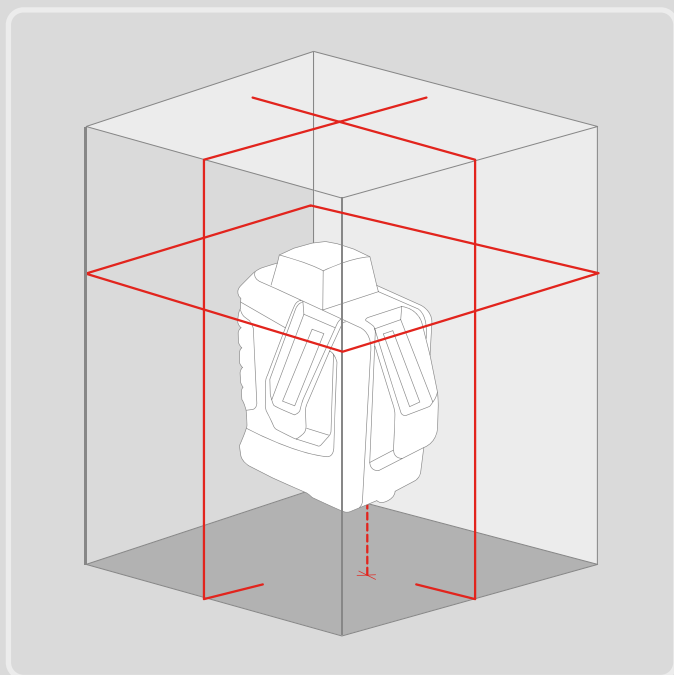

METRICA
3D
GREEN

AUTOLIVELLO LASER
METRICA 3D
METRICA 3D GREEN

Ref.				€
61400M		8001066614004	1	-
61410M		8001066614103	1	-



Ref. 61400M



Ref. 61410M

- Autolivello laser rosso (Ref. 61400M) o verde (Ref. 61410M). Proietta 3 piani laser a 360°: un piano orizzontale e due piani verticali a 90° tra loro
- Il filo a piombo sempre visibile con 4 squadri a parete
- 2 croci a soffitto e a pavimento esterni alla base della struttura
- **Vetrini Ottici**
- **Alta visibilità**
- Facile posizionamento a filo soffitto (< 2 cm)
- Uso interno ed esterno (con ricevitore non incluso)
- Lampeggio automatico del laser e avviso acustico se il dispositivo è fuori dal campo di autolivellamento
- Sistema di blocco integrato per evitare le vibrazioni durante il trasporto, possibilità di proiettare i piani laser anche in posizione fissa ed inclinata
- Forma compatta, rivestimento in gomma antiscivolo ed antiurto
- **Batteria ricaricabile Li-ion** per una lunga durata, **fornito di batteria di ricambio e caricabatterie per carica esterna.**
- **Optional:** base sliding con possibilità di piccoli spostamenti in tutte le direzioni per posizionamenti rapidi. (ref. 61335)
- **Optional:** staffa magnetica con pinza ad apertura regolabile per posizionamento a muro (ref. 61340 e ref. 61440)



Ref. 61454
IN CUSTODIA



Ref. 61453
Ref. 60866



Ref. 61452
Ref. 60713



Ref. 61450



Ref. 61451

CARATTERISTICHE TECNICHE

	61400M	61410M
Portata (secondo luminosità ambientale)	30 m	30 m
Portata con ricevitore	50 m	50 m
Precisione di livellamento	± 2 mm / 10 m	± 2 mm / 10 m
Campo di autolivellamento	± 4°	± 4°
Segnale di fuori livellamento	si	si
Tipo di laser	638 nm <1mw	520 nm <1mw
Potenza laser	classe II	classe II
Batterie ricaricabili	Li-ion 7.4V 2600 mAh	
Dimensione (mm)	140 x 160 x 85	140 x 160 x 85
Peso (senza batterie)	0,65 Kg	0,65 Kg
Impermeabilità	IP 54	IP 54
Filetto per attacco treppiedi	1/4" - 5/8"	1/4" - 5/8"

OPTIONAL



OPTIONAL



METRICA
3D
JUNIOR
GREEN

AUTOLIVELLO LASER METRICA 3D JUNIOR METRICA 3D GREEN JUNIOR

Ref.				€
61405M		8001066614059	1	-
61415M		8001066614158	1	-



Ref. 61405M



Ref. 61415M

- Autolivello laser rosso (Ref. 61405M) o verde (Ref. 61415M).
Proietta 3 piani laser a 360°: un piano orizzontale e due piani verticali a 90° tra loro
- Il filo a piombo sempre visibile con 4 squadri a parete
- 2 croci a soffitto e a pavimento esterni alla base della struttura
- Facile posizionamento a filo soffitto (< 2 cm)
- Uso interno ed esterno (con ricevitore non incluso)
- Lampeggio automatico del laser e avviso acustico se il dispositivo è fuori dal campo di autolivellamento
- Sistema di blocco integrato per evitare le vibrazioni durante il trasporto, possibilità di proiettare i piani laser anche in posizione fissa ed inclinata
- Forma compatta, rivestimento in gomma antiscivolo ed antiurto
- Batteria ricaricabile Li-ion** per una lunga durata, **fornito di batteria di ricambio e caricabatterie per carica esterna**
- Optional:** base sliding con possibilità di piccoli spostamenti in tutte le direzioni per posizionamenti rapidi. (ref. 61335)
- Optional:** staffa magnetica con pinza ad apertura regolabile per posizionamento a muro (ref. 61340 e ref. 61440)



Ref. 61454
IN CUSTODIA



Ref. 61453
Ref. 60866



Ref. 61452
Ref. 60713



Ref. 61450



Ref. 61451

CARATTERISTICHE TECNICHE

	61405M	61415M
Portata (secondo luminosità ambientale)	20 m	20 m
Portata con ricevitore	40 m	40 m
Precisione di livellamento	± 2 mm / 10 m	± 2 mm / 10 m
Campo di autolivellamento	± 4°	± 4°
Segnale di fuori livellamento	si	si
Tipo di laser	635 nm <1mw	515 nm <1mw
Potenza laser	classe II	classe II
Batterie ricaricabili	Li-ion 7.4V 2600 mAh	
Dimensione (mm)	140 x 160 x 85	140 x 160 x 85
Peso (senza batterie)	0,65 Kg	0,65 Kg
Impermeabilità	IP 54	IP 54
Filetto per attacco treppiedi	1/4" - 5/8"	1/4" - 5/8"

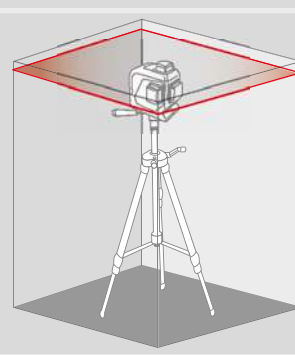
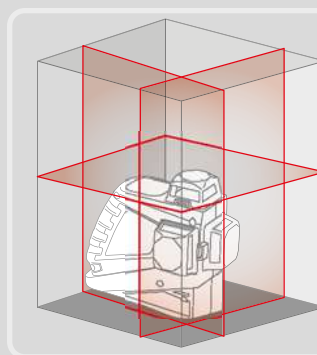

**BRAVO
LASER
XXL**

AUTOLIVELLO LASER XXL

Ref.			€
60807	8001066608072	1	-



- **Linea ORIZZONTALE COMPLETA** su 360°
- **4 croci a parete + 4 SQUADRI** completi
- PIOMBO a pavimento
- Uso interno ed esterno (con ricevitore non incluso)
- Smorzamento magnetico
- Lampeggio automatico se lo strumento si inclina oltre $\pm 2,5^\circ$
- Vite micrometrica per piccoli spostamenti
- Sistema di bloccaggio automatico per evitare vibrazioni durante il trasporto
- Base girevole
- **Spinotto per funzionamento a corrente (220 V) o 4 pile**
- Fiala di controllo per posizionamento
- Piedini in gomma regolabili in altezza



IN CUSTODIA



INCLUSO



5/8"

Ref. 60810
INCLUSO



220 V

Ref. 60817
INCLUSO



INCLUSO

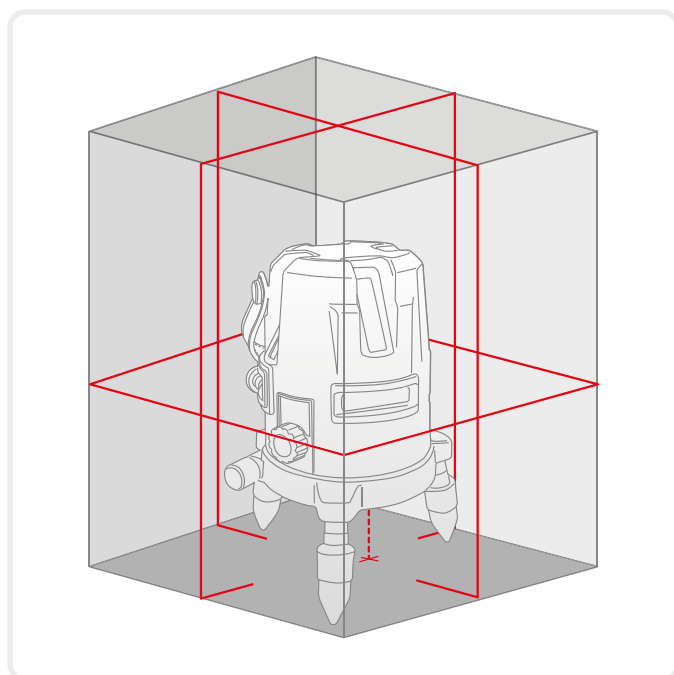

CARATTERISTICHE TECNICHE

Portata (secondo luminosità ambientale)	10 ÷ 15 m
Portata con ricevitore	50 m
Precisione di livellamento	± 2 mm / 10 m
Campo di autolivellamento	$\pm 2,5^\circ$
Smorzamento	magnetico
Segnale di fuori livellamento	si
Tipo di laser	635/650 nm
Potenza laser	classe II
Batterie (incluse)	4 x 1,5 V AA o 220 V
Dimensione (mm)	180 x 120 x 120
Peso (senza batterie)	1,7 Kg
Impermeabilità	IP 54
Filetto per attacco treppiedi	5/8"

**BRAVO
LASER**
ROTATIVO H

AUTOLIVELLO LASER ROTATIVO H GOMMATO

Ref.			€
60719BM	8001066607198	1	-



- Autolivello laser rotativo: proietta una linea rotante in orizzontale
- Sistema automatico di allineamento
- Regolazione della velocità di rotazione: 4 velocità
- Funzione **SCANNER** per tracciare una linea più visibile e più breve su 4 lunghezze a scelta
- Con ricevitore per uso esterno
- Funzione SLOPE (inclinazione manuale X, Y)**
- Funzione rotazione Passo-passo
- Alimentatore 220 V oppure con batterie ricaricabili
- Caricabatterie esterno
- Funzione TILT:** il raggio arresta la rotazione e lampeggia in caso di spostamento dello strumento



IN CUSTODIA



Ref. 60867
INCLUSO



Ref. 60735
INCLUSO



Ref. 60736
INCLUSO



220 V
INCLUSO

CARATTERISTICHE TECNICHE

Precisione di livellamento	orizzontale ± 3 mm / 30 m
Campo di autolivellamento	$\pm 5^\circ$
Autonomia	circa 8 ore
Smorzamento	motorizzato
Campo di lavoro	400 m \varnothing
Valori di rotazione	0-60-120-300-600 giri al min.
Funzione scanner	0° - 10° - 45° - 90° - 180°
Segnale di fuori livellamento	si
Tipo di laser	635 nm, 1 mW
Potenza laser	classe II
Batterie ricaricabili esternamente	DC 4.8-6 V - 4 x 1,2 Ni-MH 2500 mAh
Dimensione (mm)	120 x 120 x 150
Peso (senza batterie)	1,2 Kg
Temperatura di esercizio	- 10 °C / + 45 °C
Impermeabilità	IP 54
Filetto per attacco treppiedi	5/8"
Portata telecomando	circa 20 m
Batterie telecomando	2 x 1,5 V DC
Batterie ricevitore	9 V DC

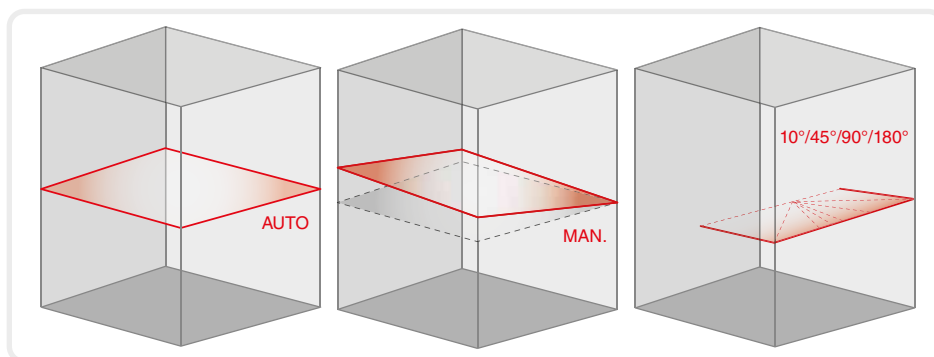

**BRAVO
LASER
ROTATIVO H**

AUTOLIVELLO LASER ROTATIVO H GOMMATO

Ref.			€
60719	8001066607198	1	-



- Autolivello laser rotativo: proietta una linea rotante in orizzontale
- Sistema automatico di allineamento
- Regolazione della velocità di rotazione: 4 velocità
- Con ricevitore per uso esterno
- **Funzione TILT:** il raggio arresta la rotazione e lampeggia in caso di spostamento dello strumento
- **Funzione SLOPE (inclinazione manuale X o Y) orientabile con telecomando**
- Batterie ricaricabili in macchina



IN CUSTODIA



Ref. 60744
INCLUSO



Ref. 60724
INCLUSO



220 V
Ref. 60726
INCLUSO

CARATTERISTICHE TECNICHE

Precisione di livellamento	orizzontale ± 3 mm / 30 m
Campo di autolivellamento	$\pm 5^\circ$
Autonomia	circa 20 ore
Smorzamento	motorizzato
Campo di lavoro	500 m \varnothing
Valori di rotazione	0-60-120-300-600 giri al min.
Funzione Tilt	si
Segnale di fuori livellamento	si
Tipo di laser	635 nm
Potenza laser	classe II
Batterie ricaricabili	DC 4.8 - 6 V
Dimensione (mm)	190 x 145 x 166
Peso (senza batterie)	2,0 Kg
Temperatura di esercizio	- 20 °C / + 50 °C
Impermeabilità	IP 64
Filetto per attacco treppiedi	5/8"
Portata telecomando	circa 20 m
Batterie telecomando	2 x 1,5 V DC
Batterie ricevitore	9 V DC

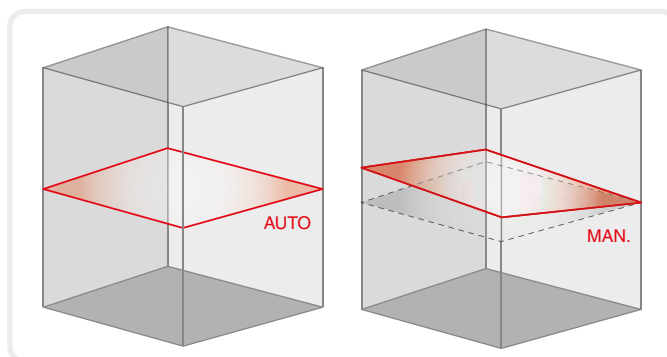

**BRAVO
LASER**
ROTATIVO HV

AUTOLIVELLO LASER ROTATIVO RICEZIONE 4 LATI

Ref.			€
61355	8001066613557	1	-



IN CUSTODIA



Ref. 60735
INCLUSO



Ref. 60736
INCLUSO



220 V
Ref. 60726
INCLUSO

- Rivestimento robusto in gomma antiscivolo
- Calotta con vetri maggiorati
- Autolivello laser con raggio rotante visibile: genera un piano orizzontale autolivellato e la linea di piombo
- Impermeabilità IP 64: protetto dall'ingresso della polvere e spruzzi d'acqua
- Ruotando l'apparecchio di 90°, genera un piano laser verticale autolivellato e un raggio orizzontale
- Funzione **SCANNER** per tracciare una linea più visibile e più breve su 4 lunghezze a scelta
- Funzione rotazione Passo-passo
- Funzione **MANUALE** che esclude il livellamento automatico e permette di inclinare a piacimento l'apparecchio in direzione X, Y per il tracciamento di piani inclinati
- Funzione **TILT**: in caso di spostamento involontario il raggio si arresta e dopo 10 secondi lo strumento si spegne
- Funzione **SLOPE** manuale
- Ricezione del telecomando sui 4 lati dell'apparecchio

CARATTERISTICHE TECNICHE

Precisione di livellamento	orizzontale	± 3 mm / 30 m
	verticale	± 5 mm / 30 m
Campo di autolivellamento	± 5°	
Autonomia	circa 20 ore	
Campo di lavoro	400 m Ø (con ricevitore) a seconda delle condizioni climatiche	
Valori di rotazione	0 - 60 - 120 - 300 - 600 giri al min.	
Funzione scanner	0° - 10° - 45° - 90° - 180°	
Funzione Tilt	sì	
Segnale di fuori livellamento	sì	
Tipo di laser	635 nm, 1 mW	
Potenza laser	classe II	
Batterie ricaricabili con 220 V	4 x NiMH C4000mAh 1,2 V	
Dimensione (mm)	160 x 200 x 200 mm	
Peso (senza batterie)	3 Kg	
Temperatura di esercizio	-10 °C / +50 °C	
Impermeabilità	IP 64	
Filetto per attacco treppiedi	5/8"	
Portata telecomando	circa 30 / 10 m (in/out)	
Angolo del telecomando	0° - 90° - 180° - 270° (4 ricevitori sul dispositivo)	
Batterie telecomando	2 x 1,5 V DC	
Batterie ricevitore	9 V DC	

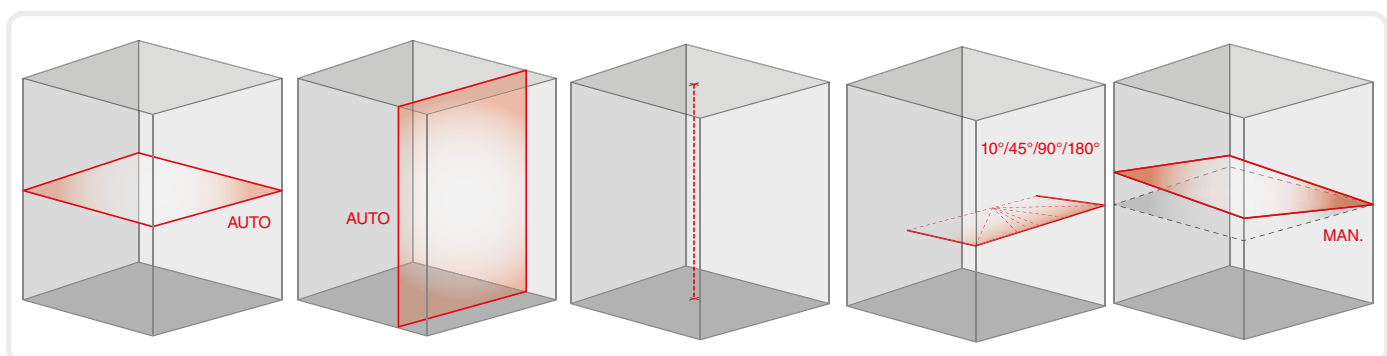

**BRAVO
LASER
ROTATIVO
SL-RED**

AUTOLIVELLO LASER ROTATIVO SL-RED

Ref.			€
60821	8001066608218	1	-



- **Autolivello laser con raggio rotante visibile rosso:** genera un piano orizzontale autolivellato e la linea di piombo
- Ruotando l'apparecchio di 90°, genera un piano laser verticale autolivellato e un raggio orizzontale
- **Funzione TILT:** in caso di spostamento involontario il raggio si arresta e dopo 10 secondi lo strumento si spegne
- Funzione automatica e manuale
- Funzione **SCANNER** 10° - 30° - 60°
- Funzione rotazione passo-passo
- **Funzione SLOPE (inclinazione manuale X, Y)**
- Uso interno ed esterno con ricevitore incluso
- Forma ergonomica
- Speciale gomma antiscivolo e antiurto
- Supporto con tre piedini regolabili in altezza, per uso verticale a muro e uso orizzontale in appoggio

CARATTERISTICHE TECNICHE

Precisione di livellamento	orizzontale	± 3 mm / 30 m
	verticale	± 5 mm / 30 m
Campo di autolivellamento	± 4°	
Autonomia	circa 20 ore	
Smorzamento	motorizzato	
Campo di lavoro	400 m Ø	
Valori di rotazione	0 - 300 - 600 giri al min.	
Funzione scanner	10° - 30° - 60°	
Funzione Tilt	si	
Segnale di fuori livellamento	si	
Tipo di laser	635 nm	
Potenza laser	classe II	
Batterie ricaricabili	220 V - 50 Hz e/o NI-MH 4 x 1,2 V DC	
Dimensione (mm)	180 x 122 x 225	
Peso (senza batterie)	2,0 Kg	
Temperatura di esercizio	0 °C / +40 °C	
Impermeabilità	IP 54	
Filetto per attacco treppiedi	5/8"	
Batterie telecomando	2 x 1,5 V AA	
Precisione di rilevazione	alta ± 1 mm	bassa ± 2,5 mm
Indicatore di ricezione del laser	Display LCD / cicalino (sonoro)	
Batterie ricevitore	9 V DC	



IN CUSTODIA



Ref. 60838
INCLUSO



Ref. 60820
INCLUSO



Ref. 60831
INCLUSO



Ref. 60818
INCLUSO

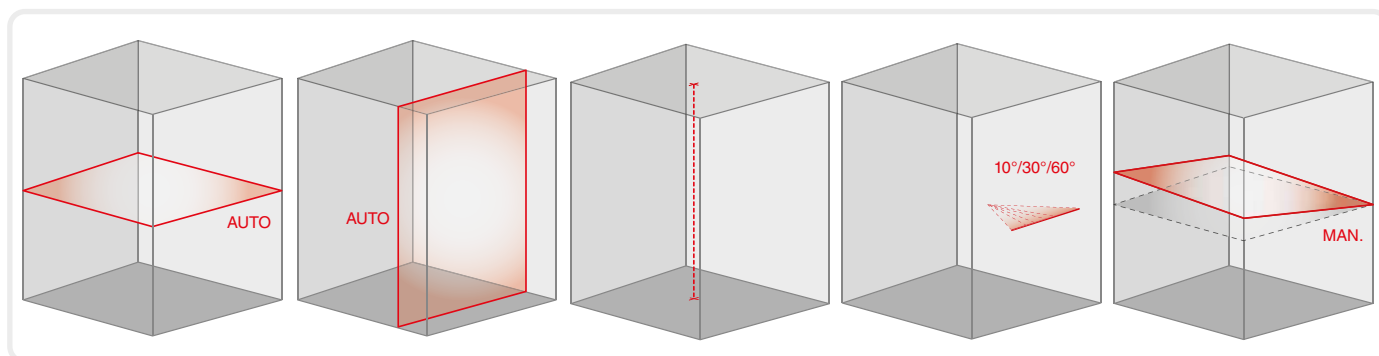

**BRAVO
LASER
ROTATIVO
SL-GREEN**

AUTOLIVELLO LASER ROTATIVO SL-GREEN

Ref.			€
60822	8001066608225	1	-



IN CUSTODIA



Ref. 60838
INCLUSO



Ref. 60820
INCLUSO



Ref. 60832
INCLUSO



220 V
Ref. 60818
INCLUSO

- **Autolivello laser con raggio rotante visibile verde:** genera un piano orizzontale autolivellato e la linea di piombo
- Ruotando l'apparecchio di 90°, genera un piano laser verticale autolivellato e un raggio orizzontale
- **Funzione TILT:** in caso di spostamento involontario il raggio si arresta e dopo 10 secondi lo strumento si spegne
- Funzione automatica e manuale
- Funzione **SCANNER** 10° - 30° - 60°
- Funzione rotazione passo-passo
- **Funzione SLOPE (inclinazione manuale X, Y)**
- Uso interno ed esterno con ricevitore incluso
- Forma ergonomica
- Speciale gomma antiscivolo e antiurto
- Supporto con tre piedini regolabili in altezza, per uso verticale a muro e uso orizzontale in appoggio

CARATTERISTICHE TECNICHE

Precisione di livellamento	orizzontale	± 3 mm / 30 m
	verticale	± 5 mm / 30 m
Campo di autolivellamento	± 4°	
Autonomia	circa 20 ore	
Smorzamento	motorizzato	
Campo di lavoro	400 m Ø	
Valori di rotazione	0 - 300 - 600 giri al min.	
Funzione scanner	10° - 30° - 60°	
Funzione Tilt	si	
Segnale di fuori livellamento	si	
Tipo di laser	532 / 650 nm	
Potenza laser	3R	
Batterie ricaricabili	220 V - 50 Hz e/o NI-MH 4 x 1,2 V DC	
Dimensione (mm)	180 x 122 x 225	
Peso (senza batterie)	2,0 Kg	
Temperatura di esercizio	0 °C / +40 °C	
Impermeabilità	IP 54	
Filetto per attacco treppiedi	5/8"	
Batterie telecomando	2 x 1,5 V AA	
Precisione di rilevazione	alta ± 1 mm	bassa ± 2,5 mm
Indicatore di ricezione del laser	Display LCD / cicalino (sonoro)	
Batterie ricevitore	9 V DC	

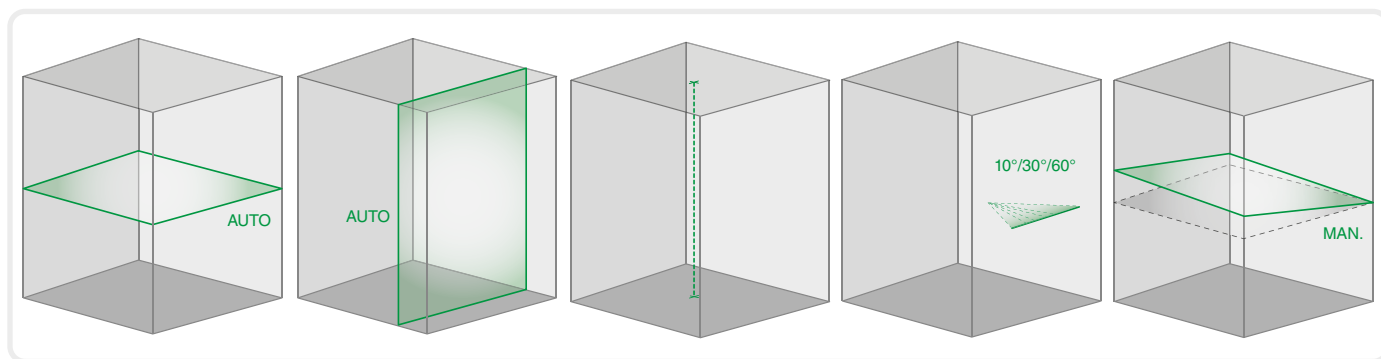

**BRAVO
LASER**
ROTATIVO HV4

AUTOLIVELLO LASER ROTATIVO RICEZIONE 4 LATI

Ref.			€
61350	8001066613502	1	-



- Autolivello laser con raggio rotante visibile rosso: genera un piano orizzontale autolivellato e la linea di piombo
- **Ricevitore ad elevata sensibilità a 4 linee**
- **Calotta con corpo in metallo**
- **Impermeabilità IP 66:** protetto dall'ingresso della polvere e acqua
- Ruotando l'apparecchio di 90°, genera un piano laser verticale autolivellato e un raggio orizzontale
- Funzione **SCANNER** per tracciare una linea più visibile e più breve su 4 lunghezze a scelta
- **Funzione SLOPE (inclinazione manuale X, Y)**
- Funzione **MANUALE** che esclude il livellamento automatico e permette di inclinare a piacimento l'apparecchio per il tracciamento di piani inclinati
- Funzione **TILT:** in caso di spostamento involontario il raggio si arresta
- Laser dotato di 4 maniglie gommate per una presa più facile e una maggiore protezione
- **Ricezione del telecomando sui 4 lati dell'apparecchio**
- Batterie ricaricabili e caricatore incluso o in alternativa 4 batterie alcaline 4 x 1,5 V LR14

CARATTERISTICHE TECNICHE

Precisione di livellamento	orizzontale	± 3 mm / 30 m
	verticale	± 5 mm / 30 m
Campo di autolivellamento	± 5°	
Autonomia	circa 30 ore	
Campo di lavoro	500 m Ø (con ricevitore) a seconda delle condizioni climatiche	
Valori di rotazione	0 - 60 - 120 - 300 - 600 giri al min.	
Funzione scanner	10° - 45° - 90° - 180°	
Funzione Tilt	si	
Segnale di fuori livellamento	si	
Tipo di laser	635 nm	
Potenza laser	classe II	
Batterie ricaricabili	4 x C4000 mAh 1,2 V NI-MH	
Dimensione (mm)	220 x 220 x 210 mm	
Peso (senza batterie)	3,5 Kg	
Temperatura di esercizio	-10 °C / +50 °C	
Impermeabilità	IP 66	
Filetto per attacco treppiedi	5/8"	
Portata telecomando	circa 30 / 10 m (in/out)	
Batterie telecomando	2 x 1,5 V DC	
Batterie ricevitore	9 V DC	



IN CUSTODIA

Ref. 60735
INCLUSO

Ref. 61328
INCLUSO

Ref. 60726
INCLUSO

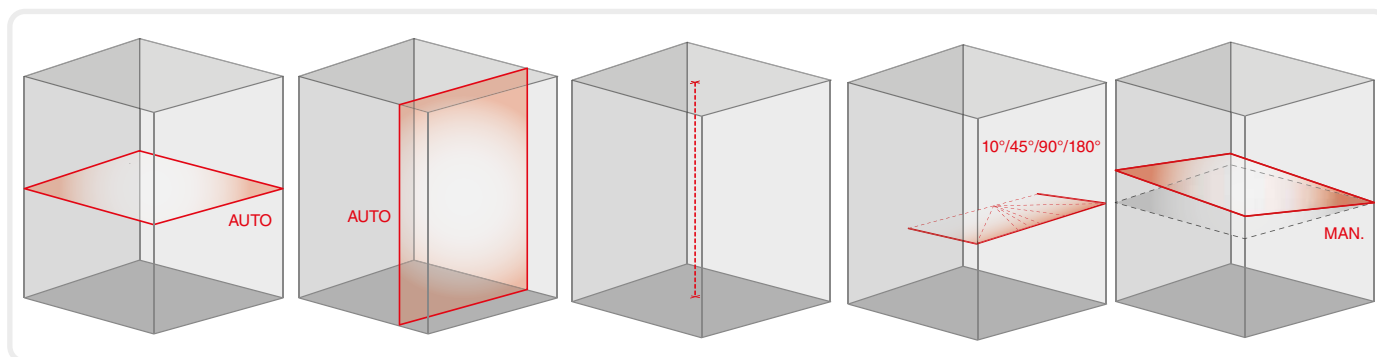

**BRAVO
LASER**
ROTATIVO HV4

AUTOLIVELLO LASER ROTATIVO RICEZIONE 4 LATI

Ref.	Barcode	Box	€
61352	8001066613526	1	-



IN CUSTODIA

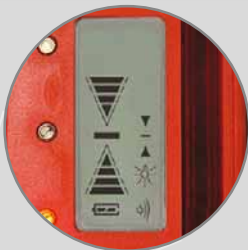

Ref. 60735
INCLUSO



Ref. 61329
INCLUSO



Ref. 60726
INCLUSO

- Autolivello laser con raggio rotante visibile **verde**: genera un piano orizzontale autolivellato e la linea di piombo
- Ricevitore ad elevata sensibilità a 4 linee
- Calotta con corpo in metallo
- Impermeabilità IP 66: protetto dall'ingresso della polvere e acqua
- Ruotando l'apparecchio di 90°, genera un piano laser verticale autolivellato e un raggio orizzontale
- Funzione **SCANNER** per tracciare una linea più visibile e più breve su 4 lunghezze a scelta
- Funzione **SLOPE (inclinazione manuale X, Y)**
- Funzione **MANUALE** che esclude il livellamento automatico e permette di inclinare a piacimento l'apparecchio per il tracciamento di piani inclinati
- Funzione **TILT**: in caso di spostamento involontario il raggio si arresta
- Laser dotato di 4 maniglie gommate per una presa più facile e una maggiore protezione
- Ricezione del telecomando sui 4 lati dell'apparecchio
- Batterie ricaricabili e caricatore incluso o in alternativa 4 batterie alcaline 4 x 1,5 V LR14

CARATTERISTICHE TECNICHE

Precisione di livellamento	orizzontale	± 3 mm / 30 m
	verticale	± 5 mm / 30 m
Campo di autolivellamento	± 5°	
Autonomia	circa 30 ore	
Campo di lavoro	500 m Ø (con ricevitore) a seconda delle condizioni climatiche	
Valori di rotazione	0 - 60 - 120 - 300 - 600 giri al min.	
Funzione scanner	10° - 45° - 90° - 180°	
Funzione Tilt	si	
Segnale di fuori livellamento	si	
Tipo di laser	515 nm, <1 mW - 638nm, <1 mW	
Potenza laser	classe II	
Batterie ricaricabili	4 x C4000 mAh 1,2 V NI-MH	
Dimensione (mm)	220 x 220 x 210 mm	
Peso (senza batterie)	3,5 Kg	
Temperatura di esercizio	-10 °C / +50 °C	
Impermeabilità	IP 66	
Filetto per attacco treppiedi	5/8"	
Portata telecomando	circa 30 / 10 m (in/out)	
Batterie telecomando	2 x 1,5 V DC	
Batterie ricevitore	9 V DC	

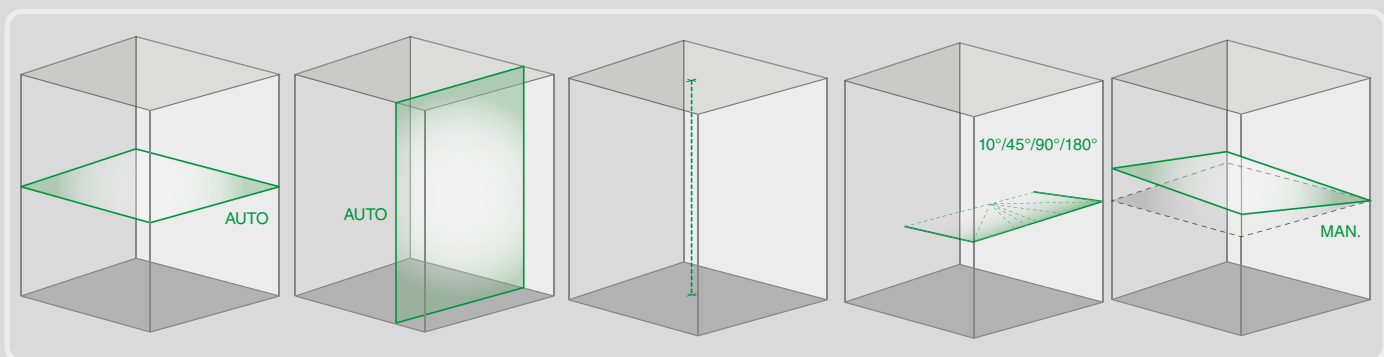

AUTOLIVELLO LASER ROTATIVO RICEZIONE 4 LATI FORNITO SENZA RICEVITORE

Ref.			€
61349	8001066613496	1	-

Ref. **61349**



- Autolivello laser con raggio rotante visibile rosso: genera un piano orizzontale autolivellato e la linea di piombo
- **Calotta con corpo in metallo**
- **Impermeabilità IP 66:** protetto dall'ingresso della polvere e acqua
- Ruotando l'apparecchio di 90°, genera un piano laser verticale autolivellato e un raggio orizzontale
- Funzione **SCANNER** per tracciare una linea più visibile e più breve su 4 lunghezze a scelta
- **Funzione SLOPE (inclinazione manuale X, Y)**
- Funzione **MANUALE** che esclude il livellamento automatico e permette di inclinare a piacimento l'apparecchio per il tracciamento di piani inclinati
- Funzione **TILT:** in caso di spostamento involontario il raggio si arresta
- Laser dotato di 4 maniglie gommate per una presa più facile e una maggiore protezione
- **Ricezione del telecomando sui 4 lati dell'apparecchio**
- Batterie ricaricabili e caricatore incluso o in alternativa 4 batterie alcaline 4 x 1,5 V LR14

CARATTERISTICHE TECNICHE

Precisione di livellamento	orizzontale	± 3 mm / 30 m
	verticale	± 5 mm / 30 m
Campo di autolivellamento	± 5°	
Autonomia	circa 30 ore	
Campo di lavoro	500 m Ø (con ricevitore) a seconda delle condizioni climatiche	
Valori di rotazione	0 - 60 - 120 - 300 - 600 giri al min.	
Funzione scanner	10° - 45° - 90° - 180°	
Funzione Tilt	si	
Segnale di fuori livellamento	si	
Tipo di laser	635 nm	
Potenza laser	classe II	
Batterie ricaricabili	4 x C4000 mAh 1,2 V NI-MH	
Dimensione (mm)	220 x 220 x 210 mm	
Peso (senza batterie)	3,5 Kg	
Temperatura di esercizio	-10 °C / +50 °C	
Impermeabilità	IP 66	
Filetto per attacco treppiedi	5/8"	
Portata telecomando	circa 30 / 10 m (in/out)	
Batterie telecomando	2 x 1,5 V DC	



IN CUSTODIA



Ref. **60735**
INCLUSO



220 V
Ref. **60726**
INCLUSO

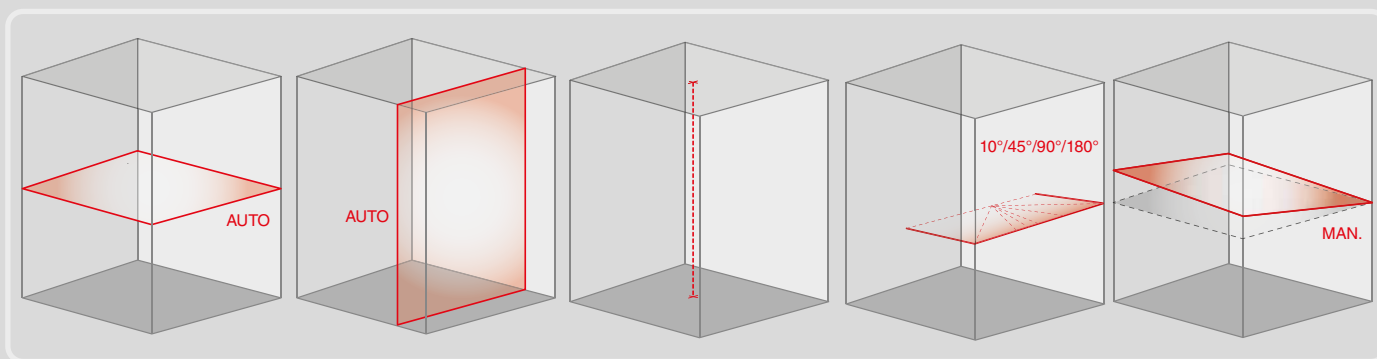

KIT CON RICEVITORI

Ref.	Barcode	Quantity	€
61354	8001066613540	1	-



Ref. 61349



Ref. 60735
INCLUSO



220 V
Ref. 60726
INCLUSO



IN CUSTODIA

61354 KIT



Ref. 61326

- Sensibilità 4 linee + **indice lettura mm/inch**
- Precisione ± 1 mm / $\pm 2,5$ mm / ± 5 mm

Ref.	Barcode	Quantity	€
61353	8001066613533	1	-



Ref. 61349



Ref. 60735
INCLUSO



220 V
Ref. 60726
INCLUSO



IN CUSTODIA

61353 KIT



Ref. 61328

- Sensibilità 4 linee
- Precisione ± 1 mm / $\pm 2,5$ mm / ± 5 mm

Ref.	Barcode	Quantity	€
61351	8001066613519	1	-



Ref. 61349



Ref. 60735
INCLUSO



220 V
Ref. 60726
INCLUSO



IN CUSTODIA

61351 KIT



Ref. 60736

- Precisione ± 1 mm / ± 5 mm

**BRAVO
LASER
ROTATIVO
INCLIGRAD 2**

AUTOLIVELLO LASER ROTATIVO CON PIANO INCLINABILE 4 MANIGLIE

Ref.			€
61345	8001066613458	1	-



- Ricevitore ad alta sensibilità e indicazione dello scostamento in mm
- Calotta con corpo in metallo
- Genera un piano orizzontale, verticale o **inclinato regolabile di $\pm 10\%$** in direzione X e Y, ed il punto piombo
- Impostazione del piano inclinato visualizzabile sul display
- Ruotando l'apparecchio di 90° , genera un piano laser verticale autolivellato e un raggio orizzontale
- **Funzione SCANNER** per tracciare una linea più visibile e più breve su 4 lunghezze a scelta: $10^\circ - 45^\circ - 90^\circ - 180^\circ$
- **Funzione TILT:** in caso di spostamento involontario il raggio si arresta
- **Funzione rotazione PASSO-PASSO**
- Funzione **MANUALE** che esclude il livellamento automatico
- Laser dotato di 4 maniglie gommate per una presa più facile e una maggiore protezione
- **Ricezione del telecomando sui 4 lati dell'apparecchio per impostazione inclinazione assi X e Y**
- Batterie ricaricabili e caricatore incluso o in alternativa 4 batterie alcaline 4 x 1,5 V LR14

CARATTERISTICHE TECNICHE

Precisione di livellamento	orizzontale	$\pm 3 \text{ mm} / 30 \text{ m}$
	verticale	$\pm 5 \text{ mm} / 30 \text{ m}$
Campo di autolivellamento	$\pm 5^\circ$	
Range regolazione pendenza	$\pm 10\%$	
Sistema di livellamento	Sensore elettronico veloce	
Autonomia	circa 30 ore	
Campo di lavoro	500 m \varnothing (con ricevitore) a seconda delle condizioni climatiche	
Valori di rotazione	0 - 60 - 120 - 300 - 600 giri al min.	
Funzione scanner	$10^\circ - 45^\circ - 90^\circ - 180^\circ$	
Funzione Tilt	sì	
Segnale di fuori livellamento	sì	
Tipo di laser	635 nm	
Potenza laser	classe II	
Batterie ricaricabili	4 x C4000 mAh 1,2 V NI-MH	
Dimensione (mm)	220 x 220 x 210 mm	
Peso (senza batterie)	3,5 Kg	
Temperatura di esercizio	$-10^\circ \text{ C} / +50^\circ \text{ C}$	
Impermeabilità	IP 54	
Filetto per attacco treppiedi	5/8"	
Portata telecomando	circa 50 / 20 m (in/out)	
Batterie telecomando	2 x 1,5 V DC	
Batterie ricevitore	9 V DC	



YouTube



IN CUSTODIA



Ref. 61324
INCLUSO



Ref. 61326
INCLUSO



220 V
Ref. 60726
INCLUSO

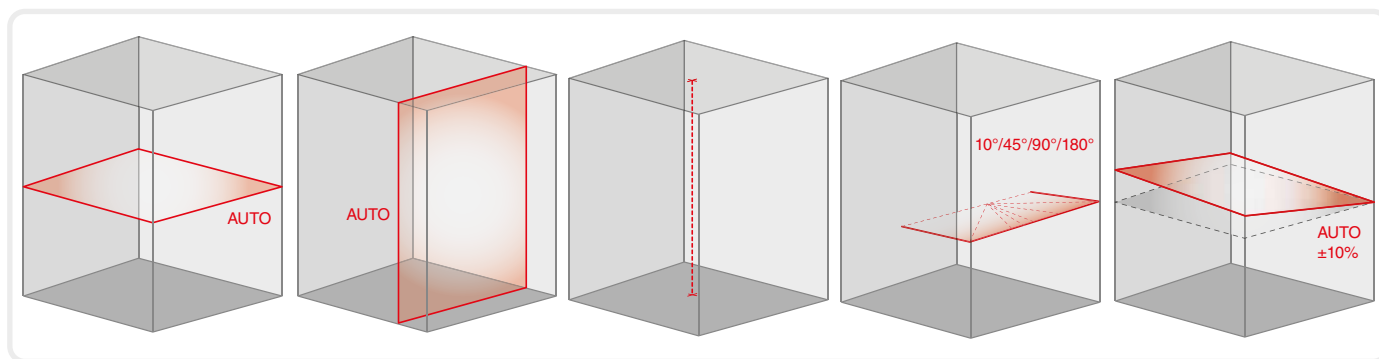



ESPOSITORI PER BRAVOLASER

Ref.	L x H x P		€
EXPO AUTOL	45 x 200 x 30 cm	1	-

■ Composizione LIBERA



	 = DI SERIE	 = OPTIONAL										
			Ref. 60804 pag. 9	Ref. 60805 pag. 10	Ref. 61360 pag. 11	Ref. 61365 pag. 11	Ref. 61435 pag. 13	Ref. 61370 pag. 14	Ref. 61375 pag. 14	Ref. 608148R pag. 15	Ref. 61380 pag. 15	Ref. 61400M pag. 16
 Ref. 61331 pag. 34												
 Ref. 61332 pag. 34												
 Ref. 60811 pag. 34												
 Ref. 60748 pag. 34												
 Ref. 60749 pag. 34												
 Ref. 60726 pag. 34												
 Ref. 61328 pag. 35												
 Ref. 61326 pag. 35												
 Ref. 61329 pag. 35												
 Ref. 60736 pag. 35												
 Ref. 61326 pag. 35												
 Ref. 61328 pag. 35												

Le portate dei ricevitori possono variare a seconda delle condizioni ambientali (luce, umidità, vento, ecc.)

Ref. 61410M	Ref. 61405M	Ref. 61415M	Ref. 60807	Ref. 60719BM	Ref. 60719	Ref. 61355	Ref. 60821	Ref. 60822	Ref. 61350	Ref. 61352	Ref. 61345
pag. 16	pag. 17	pag. 17	pag. 18	pag. 19	pag. 20	pag. 21	pag. 22	pag. 23	pag. 24	pag. 25	pag. 28
	● 20 m										
● 30 m		● 20 m									
			● 50 m								
	● 40 m										
● 50 m		● 40 m									
				●		●			●		●
						●			●		●
						●			●		●
										●	
					●						
							●				
								●			

Le portate dei ricevitori possono variare a seconda delle condizioni ambientali (luce, umidità, vento, ecc.)

RICEVITORE CONTROLLO MOVIMENTO TERRA

Ref.			€
60833	8001066608331	1	—
60873	8001066608737	1	—
60871	8001066608713	1	—
60872	8001066608720	1	—



Ref. **60833**

- Ref. **60833** con bloccaggio a morsetto
- Ref. **60873** con bloccaggio a magnete
- Permette il controllo del livellamento del terreno sulle macchine di movimento terra
- Intercetta il segnale proveniente da qualsiasi laser rotativo senza distinzione di marca
- Lunghezza della barra di ricezione 25 cm su un arco di 360°
- Diodi luminosi intercettano la linea laser
- Dotato di staffe con attacco a vite o a magnete per il fissaggio del dispositivo sulle macchine movimento terra
- Doppia precisione a scelta
- **Protezione** antipolvere e antiacqua **IP 66**
- Dispositivo di controllo remoto in cabina
- Fornito con caricabatterie 220 V, cavo per batterie veicolo 12 V, cavo di collegamento tra ricevitore e ricevitore remoto
- Durata batterie circa 40 ore
- Ref. **60871** 2 bloccaggi a morsetto (ricambio)
- Ref. **60872** 2 bloccaggi a magnete (ricambio)



RICEVITORE



IN CUSTODIA



220 V

INCLUSO

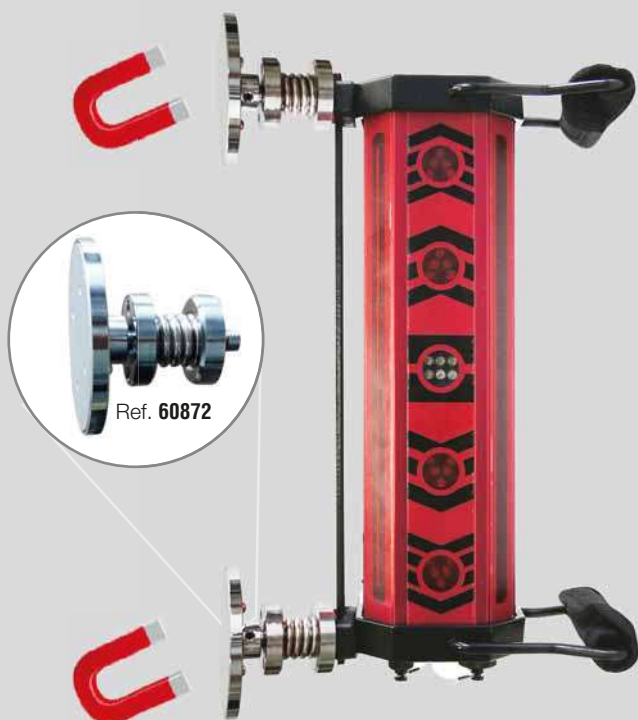



Ref. **60873**

CARATTERISTICHE TECNICHE

Precisione fine	± 2 mm / ± 10 mm
Precisione grossolana	± 5 mm / ± 23 mm
Batterie	7,2 V NiMH/2500 mAh
Tempo di ricarica delle batterie	circa 10 ore
Dimensione (mm)	376 x 180 x 60
Peso (senza batterie)	3,0 Kg
Temperatura di esercizio	- 20 °C / + 50 °C
Impermeabilità	IP 66



RICEVITORE FOLLOW ME + BASE ROTANTE

Ref.			€
60611	8001066606115	1	-

- Funzione **Follow Me**: centratura automatica del raggio verticale sul ricevitore nel punto desiderato (fig. A)
- Funzione **radiocomando remoto**: comando/controllo della rotazione dalla base rotante (consente di lavorare senza bisogno di aiuto - fig. B)
- Funzione scanner: rileva i raggi laser come un normale ricevitore



10

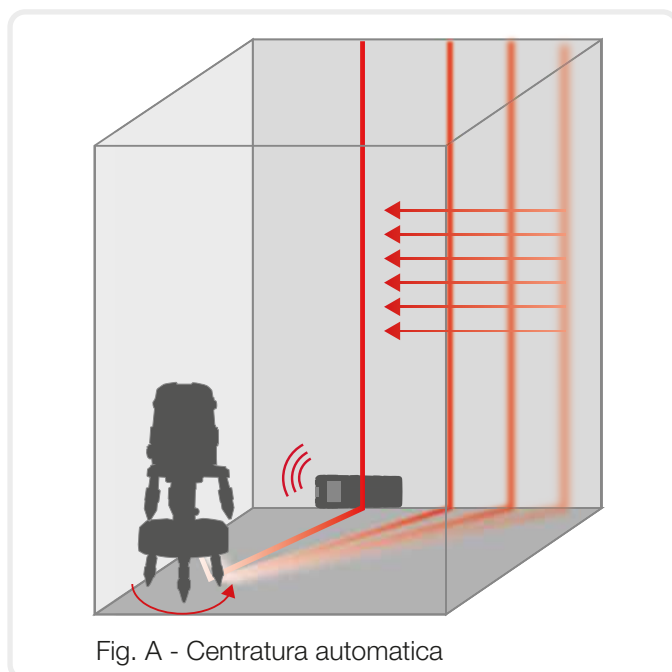



RICEVITORE PER ESTERNI PER LASER A PENDOLO

Ref.				€
61331	●	8001066613311	1	–
61332	●	8001066613328	1	–
60727		8001066607273	1	–

- Ricevitore per autolivelli laser a pendolo (**Rosso** e/o **Verde**)
- Segnale: Led luminoso e Beep acustico
- Fornito con staffa di fissaggio
- Portata 30 m a seconda del tipo di laser
- Precisione $\pm 1,5$ mm / $\pm 2,5$ mm



RICEVITORE PER ESTERNI PER LASER A PENDOLO

Ref.				€
60811	●	8001066608119	1	–
60386		8001066603862	1	–

- Segnale: Led luminoso e Beep acustico
- Fornito con staffa di fissaggio
- Ref. **60811** compatibile con Ref. **60804**, **60805**, **60807**
- Capacità 30/50 m a seconda del tipo di laser
- Precisione ± 1 mm



RICEVITORE PER ESTERNI PER LASER A PENDOLO

Ref.				€
60748	●	8001066607488	1	–
60749	●	8001066607495	1	–
60741		8001066607419	1	–

- Ref. **60748** compatibile con **61400M**, **61405M**, **61360**, **61370**, **60814BR**, **60805**
- Ref. **60749** compatibile con **61410M**, **61415M**, **61380**, **61375** e **61365**
- Capacità 30 m a seconda del tipo di laser
- Precisione $\pm 1,5$ mm / $\pm 2,5$ mm



RICEVITORE PER ESTERNI PER LASER ROTATIVI

Ref.				€
60736	●	8001066607365	1	–
60727		8001066607273	1	–

- Segnale: Led luminoso e Beep acustico
- Fornito con staffa di fissaggio
- Compatibile con Ref. **61355**, **60719BM**, **61345**, **61350**, **60719**
- Capacità 400 m \emptyset
- Precisione ± 1 mm / ± 5 mm



Ref. **61319**
INCLUSO O VENDIBILE
SINGOLARMENTE

RICEVITORE PROFESSIONALE PER LASER ROTATIVI

Ref.				€
61328	●	8001066613281	1	-
61329	●	8001066613298	1	-
61319		8001066613199	1	-

- Segnale: Led luminoso e Beep acustico
- Fornito con staffa di fissaggio
- Ref. **61328** compatibile con Ref. **61345, 61350, 61355, 60719**
- Ref. **61329** compatibile con Ref. **61352**
- Sensibilità 4 linee
- Capacità 700 m Ø
- Precisione $\pm 1 \text{ mm} / \pm 2,5 \text{ mm} / \pm 5 \text{ mm}$



Ref. **61319**
INCLUSO O VENDIBILE
SINGOLARMENTE

RICEVITORE PROFESSIONALE CON LETTURA IN MM PER LASER

Ref.				€
61326	●	8001066613267	1	-
61319		8001066613199	1	-

- Segnale: Led luminoso e Beep acustico
- Fornito con staffa di fissaggio
- Compatibile con Ref. **61345, 61350, 61355, 60719**
- Sensibilità 4 linee con indice lettura mm/inch
- Capacità 700 m Ø
- Precisione $\pm 1 \text{ mm} / \pm 2,5 \text{ mm} / \pm 5 \text{ mm}$



Ref. **60727**
INCLUSO O VENDIBILE
SINGOLARMENTE

RICEVITORE PER ESTERNI PER LASER ROTATIVI

Ref.				€
60724	●	8001066607242	1	-
60727		8001066607273	1	-

- Segnale: Led luminoso e Beep acustico
- Fornito con staffa di fissaggio
- Compatibile con Ref. **60719**
- Capacità 400 m Ø
- Precisione $\pm 1 \text{ mm} / \pm 2,5 \text{ mm}$



Ref. **60835**
INCLUSO O VENDIBILE
SINGOLARMENTE

RICEVITORE PER ESTERNI PER LASER ROTATIVI

Ref.				€
60831	●	8001066608317	1	-
60832	●	8001066608324	1	-
60835		8001066608355	1	-

- Segnale: Led luminoso e Beep acustico
- Fornito con staffa di fissaggio
- Ref. **60831** Compatibile con Ref. **60821**
- Ref. **60832** Compatibile con Ref. **60822**
- Capacità 400 m Ø
- Precisione $\pm 1 \text{ mm} / \pm 2,5 \text{ mm}$



**TELECOMANDO
PER LASER ROTATIVI**

Ref.			€
60744	8001066607440	1	-

- Portata 20 m
- Compatibile con Ref. **60719**



**TELECOMANDO
PER LASER ROTATIVI**

Ref.			€
60735	8001066607358	1	-

- Portata 20 m
- Compatibile con Ref. **61355, 61350, 60719BM, 61352, 61349**



**TELECOMANDO
PER LASER ROTATIVI**

Ref.			€
60820	8001066608201	1	-

- Portata 20 m
- Compatibile con Ref. **60821, 60822**



**RADIOCOMANDO
PER LASER ROTATIVI**

Ref.			€
61324	8001066613243	1	-

- Portata 50 m
- Compatibile con Ref. **61345**



SUPPORTO MAGNETICO PER MURATURA E CARTONGESSISTI

Ref.			€
61340	8001066613403	1	-

- Staffa magnetica
- Possibile utilizzo su: profilato max 5 mm, parete in metallo ferroso, con tasselli /chiodi
- Utilizzabile con Ref. **61400M, 61405M, 61410M, 61415M**

10



SUPPORTO MAGNETICO PER MURATURA E CARTONGESSISTI

Ref.			€
61440	8001066614400	1	-

- Staffa magnetica
- Possibile utilizzo su: profilato max 10 mm, parete in metallo ferroso, con tasselli /chiodi
- Utilizzabile con Ref. **61400M, 61405M, 61410M, 61415M**



SUPPORTO MAGNETICO PER MURATURA E CARTONGESSISTI

Ref.			€
61342	8001066613427	1	-

- Staffa magnetica
- Possibile utilizzo su: profilato max 10 mm, parete in metallo ferroso, con tasselli /chiodi
- Utilizzabile con Ref. **61400M, 61405M, 61410M, 61415M**

SUPPORTO A MURO MAGNETICO

Ref.	Barcode	Box	€
60837	8001066608379	1	-

■ Utilizzabile con Ref. **60805, 60814**



SUPPORTO A MURO MAGNETICO

Ref.	Barcode	Box	€
60714 M	8001066607143	1	-

■ Utilizzabile con Ref. **61300, 60804, 60805**

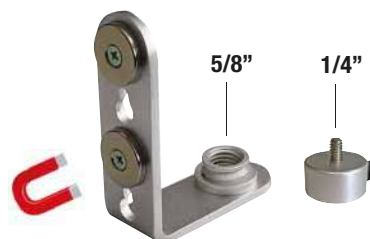

BASE SLIDING

Ref.	Barcode	Box	€
61335	8001066613359	1	-

- Base girevole per laser
- Permette la rotazione e la traslazione delle proiezioni laser per una facile tracciatura e controllo in qualsiasi posizione
- Avvitabile su un treppiede con filetto 5/8"
- Piedini regolabili
- Attacco 5/8" per laser
- Movimento rapido più regolazione fine
- Utilizzabile con Ref. **61400M, 61405M, 61410M, 61415M**



SUPPORTO TREMPIEDE

Ref.	Barcode	Box	€
60838	8001066608386	1	-

■ Utilizzabile con Ref. **60821, 60822**



SUPPORTO PER INCLINAZIONE 0-90°

Ref.	Barcode	Box	€
60830	8001066608300	1	-

■ Base per l'inclinazione di laser rotativi con graduazione



SUPPORTO PER ASTA TELESCOPICA

Ref.	Barcode	Box	€
60562	8001066605620	1	-

- Supporto per asta Ref. **60559** / Ref. **60560**
- Filetto 5/8"
- Bloccaggio rapido



PROLUNGA FILETTO 5/8"

Ref.	Barcode	Unit	€
60810	8001066608102	1	-

- Prolunga in metallo filetto maschio/femmina
- Utilizzabile con Ref. **60807**



ADATTATORE 1/4" - 5/8"

Ref.	Barcode	Unit	€
60815	8001066608157	1	-
60738	8001066607389	1	-

- Utilizzabili con Ref. **61300, 60804, 60805, 60370, 61375, 60814BR, 61380, 61360, 61365**
- Giunto rotante 360° (Ref. **60815**)
- Giunto fisso (Ref. **60738**)



PINZA UNIVERSALE

Ref.	Barcode	Unit	€
60816	8001066608164	1	-

- Utilizzabile con Ref. **61300, 60804, 60805**



TARGET

Ref.	Color	Barcode	Unit	€
60713	Red	8001066607136	1	-
60866	Green	8001066608669	1	-

- Magnetico



Ref. **60866**

Ref. **60713**

OCCHIALI PER LASER

Ref.	Color	Barcode	Unit	€
61452	Red	8001066614523	1	-
61453	Green	8001066614530	1	-

- Accresce la visibilità del punto o della linea laser in ambienti luminosi



Ref. **61453**

Ref. **61452**

VALIGETTA PER LASER

Ref.	Barcode	Unit	€
61454	8001066614547	1	-

- Per protezione e trasporto laser Ref. **61400M, 61405M, 61410M, 61415M**



RICAMBIO BATTERIA LASER 3D

Ref.			€
61450	8001066614509	1	-

■ Adatto per Ref. **61400M, 61405M, 61410M, 61415M**



BATTERIE RICAMBIO PER ROTATIVI

Ref.			€
60746	8001066607464	1	-

■ Adatto per Ref. **60719, 60719BR**
 ■ 1 set di 4 pezzi



CARICABATTERIE PER LASER 3D

Ref.			€
61451	8001066614516	1	-

■ Adatto per Ref. **61450**



CARICABATTERIE

Ref.			€
60867	8001066608676	1	-

■ Adatto per Ref. **60746**



RICAMBIO BATTERIA PER LASER BRAVO BOX 3

Ref.			€
61445	8001066614455	1	-

■ Adatto per laser Ref. **61420, 61430**



BATTERIE RICAMBIO

Ref.			€
60728	8001066607280	1	-

■ Adatto per laser Ref. **60722** (fuori produzione) e Ref. **60723** (fuori produzione)
 ■ 1 set di 4 pezzi



BATTERIE RICAMBIO PER ROTATIVI

Ref.			€
60747	8001066607471	1	-

■ Adatto per Ref. **61349, 61350, 61352, 61345, 61355**

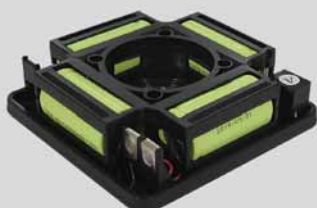

BATTERIE RICAMBIO

Ref.			€
60819	8001066608195	1	-

■ Adatto per Ref. **60821, 60822**





ASTE TELESCOPICHE CON STAFFA

Ref.	L			€
60559	3,6 m	8001066605590	1	-

- Costituita da 4 pezzi avvitabili (max 3,60 m)
- Piano di appoggio scorrevole
- Due piattelli per adattamento a soffitto e pavimento
- Regolazione dell'altezza grazie ad un'asta telescopica con bloccaggio a ghiera
- Piano d'appoggio scorrevole lungo la verticale, con bloccaggio rapido a leva, con filetto 5/8"
- Fornito con prolunga 5/8" (Ref. **60810**)

Ref.	L			€
60560	3,6 m	8001066605606	1	-

- Costituita da 4 pezzi avvitabili (max 3,60 m)
- Piano di appoggio scorrevole
- **Con treppiede di sostegno**
- Regolazione dell'altezza grazie ad un'asta telescopica con bloccaggio a ghiera
- Piano d'appoggio scorrevole lungo la verticale, con bloccaggio rapido a leva, con filetto 5/8"
- Fornito con prolunga 5/8" (Ref. **60810**)

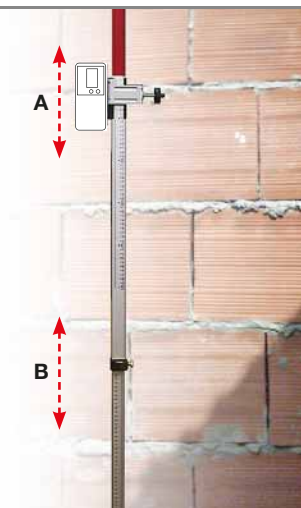
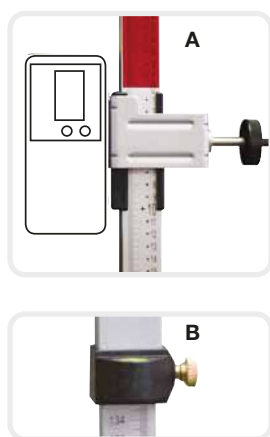

ASTA TELESCOPICA PORTA SENSORE LASER

Ref.	L			€
60621	2,4 m	8001066606214	1	-

- Altezza 2,4 m in alluminio anodizzato
- Gradazione antigraffio
- Predisposta per supportare staffa di fissaggio per sensore laser (fig. A)
- Bloccaggio rapido (fig. B)
- Corsa utile per dislivelli: ± 50 cm



STAFFA MURO/PROFILATI PER BRAVO LASER

Ref.			€
60712	8001066607129	1	-

- Staffa murale professionale
- In alluminio
- Regolabile in altezza
- 2 fori per fissaggio diretto a muro
- **Adattabile anche ad un profilato mediante doppio dispositivo di bloccaggio**

TREPPIEDE MOTORIZZATO

Ref.	L			€
60565	85 - 220 cm	8001066605651	1	-

- Elevazione a cremagliera motorizzata
- 3 gambe estensibili in alluminio tubolare robusto
- Piedini avvitabili in plastica per interni ed a punta per esterni
- Apertura a raggiera, 3 raggi di sicurezza
- Bloccaggio delle gambe a leva
- Fiala di centraggio
- Filetto 5/8", piatto Ø 50 mm
- Telecomando 3 funzioni: continuo, step by step, finecorsa
- Portata telecomando: 50 m
- Peso: 2 kg
- Protezione: IP 56
- Batterie ricaricabili: Li-ion
- Caricatore



TREPPIEDE MOTORIZZATO ROBUSTO

Ref.	L			€
60566	98 - 200 cm	8001066605668	1	-

- Elevazione a cremagliera motorizzata
- 3 gambe estensibili in alluminio tubolare robusto
- Bloccaggio delle gambe a leva
- Fiala di centraggio
- Filetto 5/8", piatto Ø 110 mm
- Telecomando 3 funzioni: continuo, step by step, finecorsa
- Portata telecomando: 50 m
- Peso: 5 kg
- Altezza tutto chiuso: 98 cm
- Protezione: IP 56
- Batterie ricaricabili: Li-ion
- Caricatore



TREPPIEDE ROBUSTO A BASE PIATTA

Ref.	L			€
60495	104 ÷ 174 cm	8001066604951	1	-

- 3 gambe estensibili in alluminio tubolare robusto
- Bloccaggio a vite
- Filetto 5/8"
- Tracolla
- Peso: 3,7 Kg



TREPPIEDE A BASE PIATTA

Ref.	L			€
60498	97 ÷ 159 cm	8001066604982	1	-
60498D	97 ÷ 159 cm	8001066604982	1	-

- 3 gambe estensibili in alluminio tubolare
- Bloccaggio rapido a leva
- Filetto 5/8"
- Tracolla
- Peso: 3,2 Kg





TREPPIEDE IN ALLUMINIO

Ref.	L			€
60585	63 ÷ 182 cm	8001066605859	1	-
60587	90 ÷ 200 cm	8001066605873	1	-
60588	90 - 290 cm	8001066605880	1	-

- Elevazione a cremagliera
- Bloccaggio a leva
- Filetto 5/8", piatto Ø 50 mm
- Piedini gommati
- Fiala di centraggio
- Apertura a raggiera, 3 raggi di sicurezza
- Sacca di trasporto
- **Peso: 1,3 Kg** (Ref. **60585**)
- **Peso: 2,1 Kg** (Ref. **69587**)
- **Peso: 3 Kg** (Ref. **60588**)





TREPPIEDE IN ALLUMINIO

Ref.	L			€
60586	90 ÷ 290 cm	8001066605866	1	-

- Elevazione a cremagliera
- Manovella con bloccaggio posteriore a leva e sistema frontale a molla di sicurezza
- Asta telescopica
- Apertura a raggiera, 3 raggi di sicurezza
- Impugnatura gommata
- Fiala di centraggio
- Piedini avvitabili in plastica per interni ed a punta per esterni
- Bloccaggio delle gambe a leva
- Filetto 5/8", piatto Ø 50 mm
- Sacca di trasporto
- **Peso: 4,8 Kg**



TREPPIEDE AD ELEVAZIONE

Ref.	L			€
60581	95 ÷ 195 cm	8001066605811	1	-
60582	112 ÷ 335 cm	8001066605828	1	-

- **Modello professionale robusto**
- Elevazione a cremagliera graduata
- Bloccaggio a leva, catenella di sicurezza
- Fiala di centraggio
- Filetto 5/8", piatto Ø 110 mm
- Tracolla di trasporto
- Piedini in plastica per interni ed a punta per esterni
- Ref. **60582** con asta telescopica 84 cm
- **Peso: 5,4 Kg** (Ref. **60581**)
- **Peso: 6 Kg** (Ref. **60582**)



TREPPIEDE IN ALLUMINIO

Ref.	L			€
60574	55 ÷ 150 cm	8001066605743	1	-

- Elevazione a cremagliera con manovella e vite di bloccaggio
- 3 gambe estensibili in alluminio tubolare robusto
- Bloccaggio rapido a leva
- Apertura a raggiera, 3 raggi di sicurezza
- Filetto 5/8", piatto Ø 50 mm
- Sacca di trasporto
- **Peso: 1,3 Kg**



**TREPPIEDE STABILE CON
SUPPORTO A MANOPOLA**

Ref.	L			€
60596	52 ÷ 138 cm	8001066605965	1	-

- Elevazione a cremagliera graduata corsa 28 cm
- Apertura a raggiera, 3 raggi di sicurezza
- Fiala di centraggio
- Piedini gommati
- Fornito con supporto amovibile a manopola per DISTO, distanziometro METRICA FLASH e Laser METRICA Bravolaser
- Orientabile e inclinabile in tutte le direzioni
- Filetto 1/4"
- In custodia a tracolla
- **Peso: 1,3 Kg**



**TREPPIEDE STABILE CON
SUPPORTO A MANOPOLA**

Ref.	L			€
60590	55 ÷ 150 cm	8001066605903	1	-

- Elevazione a cremagliera graduata corsa 28 cm
- Apertura a raggiera, 3 raggi di sicurezza
- Fiala di centraggio
- Piedini gommati
- Fornito con supporto amovibile a manopola per DISTO, distanziometro METRICA FLASH e Laser METRICA Bravolaser
- Orientabile e inclinabile in tutte le direzioni
- Filetto 1/4" (Foto A)
- Filetto 5/8" togliendo la manopola (Foto B)
- In custodia a tracolla
- **Peso: 1,2 Kg**



TREPPIEDE IN LEGNO

Ref.	L			€
60584	110 ÷ 175 cm	8001066605842	1	-

- Gambe in legno parti in alluminio presso fuse
- Dado di bloccaggio a vite
- Gambe con foro per trasporto a mano
- Lunghezza da chiuso: 110 cm
- Lunghezza aperto: 175 cm
- **Peso: 7,5 Kg**



TREPPIEDE

Ref.	L			€
60598	40 ÷ 120 cm	8001066605989	1	-

- Elevazione a cremagliera graduata corsa 20 cm
- Apertura a raggiera, 3 raggi di sicurezza
- Fiala di centraggio
- Piedini gommati
- Fornito con supporto amovibile a manopola per DISTO, distanziometro METRICA FLASH e Laser METRICA Bravolaser
- Orientabile e inclinabile in tutte le direzioni
- Filetto 1/4"
- In custodia a tracolla
- **Peso: 0,9 Kg**





IN CUSTODIA

MISURATORE OTTICO

Ref.	Zoom			€
60480	20 X	8001066604807	1	-
60467	24 X	8001066604678	1	-
60466	32 X	8001066604661	1	-

- Livello automatico 20x, 24x e 32x
- Errore medio $\pm 2,5$ mm a 1 km
- Base graduata a 360°
- Costante additiva: 0
- Precisione: $\pm 0,5''$
- Fornito in valigetta

KIT COMPOSTO DA:

- Livello automatico 20x, 24x e 32x
- Misuratore telescopico 5 m composto da 5 aste. Graduazione: fronte in mm, retro geodetica
- Treppiede in alluminio con base piatta
- Fornito con filo e piombo



Filo a piombo

Ref. 60480 / Ref. 60467 / Ref. 60466



Ref. 60498



Ref. 49205

KIT LIVELLO OTTICO 20X - 24X - 32X

Ref.	Zoom			€
89267	20 X	8001066892679	1	-
89266	24 X	8001066892662	1	-
89268	32 X	8001066892686	1	-



TEODOLITE ELETTRONICO DIGITALE DT2

Ref.	Barcode	Qty	€
60840	8001066608409	1	-

- Teodolite digitale
- Misurazione incrementale degli angoli
- 2 Display a cristalli liquidi
- Sistema ENCODER assoluto
- Batterie ricaricabili oppure 4 x 1,5 V AA
- Piombo laser

FRONTE



RETRO



IN CUSTODIA



INCLUSO



INCLUSO



INCLUSO



CARATTERISTICHE TECNICHE

Lettura minima	1"/5"
Precisione	2"
Lunghezza telescopio	156 mm
Diametro obiettivo	45 mm
Ingrandimento telescopio	30 x
Campo visivo	1° 30'
Lunghezza focale minima	1.3 m
Sensore di TILT	si
Bolla torica	30" / 2 mm
Bolla sferica	8' / 2 mm
Piombo laser	si
Alimentazione	batterie ricaricabili e/o 4 x 1,5 V AA
Temperatura d'esercizio	-20 °C / +50 °C
Peso	5,7 Kg

MISURATORI TELESCOPICI 4 - 5 m IN ALLUMINIO

Ref.						€
49204	4 m	120 cm	mm	8001066492046	1	-
49205	5 m	125 cm	mm	8001066492053	1	-

- Graduazione sulle aste:
 - fronte mm
 - retro geodetica
- Sezione esagonale robusta
- Composto da 4/5 aste telescopiche
- Fiala circolare amovibile per posizionamento verticale
- In astuccio



10



STADIA 6 ASTE PIEGHEVOLE 300 cm

Ref.	L	N			€
60090	300 cm	6	8001066600908	1	-

- Stadia pieghevole in legno
- Lunghezza totale 3 m
- Graduazione:
 - avanti mm
 - retro geodetica



CHIODI PER GEODESIA

Ref.	L	Ø			€
00250	55 mm	9 mm	800166002504	1	-

- Chiodo in acciaio trattato
- Confezione da 100 pezzi in barattolo
- Peso cadauno: 30 gr.

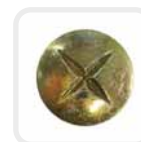



METRICA FLASH



61109

pag. 50



61110

pag. 50



61114

pag. 51



61120

pag. 52



61130
61155

pag. 53



61186

pag. 54



61190

pag. 55



61240
61260

pag. 56



61060

pag. 57

FUNZIONI

	Misura della distanza	15 m	30 m	30 m + 20 m	30 m	30 m 60 m	100 m	120 m	40 m 60 m	60 m 100 m
	Misura in continuo		●	●	●	●	●	●	●	●
	Misura minima/massima		●	●	●	●	●	●	●	●
	Misura delle superfici		●	●	●	●	●	●	●	●
	Misura dei volumi		●	●	●	●	●	●	●	●
	Area triangolo						●	●	●	●
	Funzione stanze					●	●	●	●	●
	Funzione trapezio							●	●	●
	Funzione Pitagora		●	●		●	●	●	●	●
	Misura dell'inclinazione			± 90°			± 90°	± 90°	± 90°	± 90°
	Tracciamento altezze					●	●	●	●	●
	Funzione di tracciamento					●	●	●	●	●
	Tracciamento Guidato					a/b	a/b	a/b		
	Somma/sottrazione		●	●		●	●	●	●	●
	Funzione Target Camera							●		
	Mirino con zoom 4x							●		
	Funzione fotocamera							●		
	Funzione timer					●	●	●		●
	Livella digitale						●	●	●	
	Double Laser			●						
	Rotazione schermo			●					●	
	P2P								●	
	Rotella per misura lineare								●	

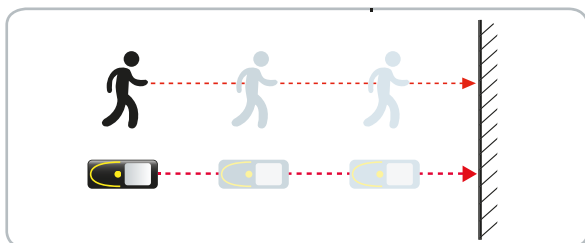

Mod. 61120, 61130, 61155, 61186, 61190, 61110, 61114, 61240, 61260, 61060, 61100
MISURAZIONE IN CONTINUO
 Il display può mostrare in contemporanea la istantanea misurazione con valore massimo e minimo sempre visualizzati

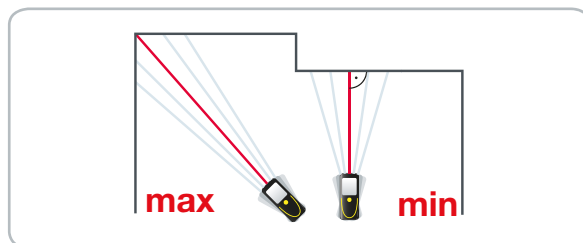

Mod. 61130, 61155, 61186, 61190, 61110, 61114, 61240, 61260, 61060, 61100
MASSIMO E MINIMO
 Il display può mostrare i risultati delle misurazioni minima e massima, durante la misura in continuo.

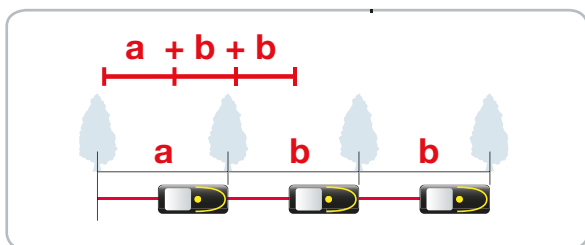

Mod. 61130, 61155, 61186, 61190
FUNZIONE TRACCIAMENTO
 L'utente può utilizzare la funzione di tracking per trovare le posizioni a distanze preimpostate (a e b possono essere differenti).

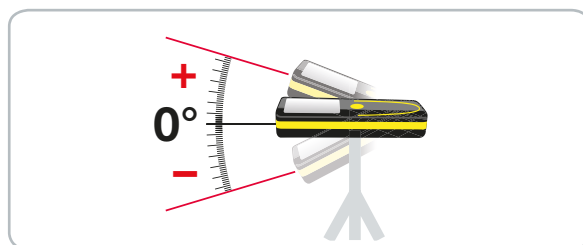

Mod. 61186, 61190, 61114, 61240, 61260, 61060, 61100
INCLINOMETRO DIGITALE
 Il display può visualizzare l'inclinazione dello strumento sull'asse x e sull'asse y.

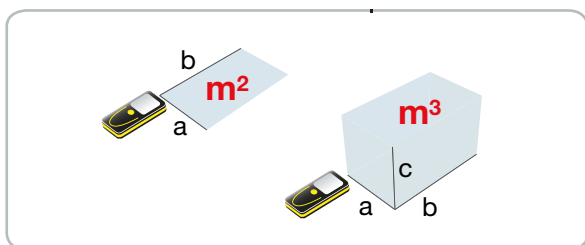

Mod. 61130, 61155, 61186, 61190, 61110, 61114, 61120, 61240, 61260, 61060, 61100
MISURAZIONE DELL'AREA e DEL VOLUME
 Lo strumento può calcolare automaticamente l'area o il volume misurando i lati, il risultato appare sul display.

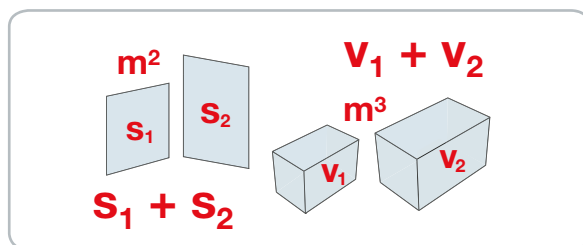

Mod. 61130, 61155, 61186, 61190, 61240, 61260, 61060, 61100
SOMMA E SOTTRAZIONE
 Lo strumento può effettuare somme e sottrazioni di due o più distanze, aree e volumi misurati consecutivamente.

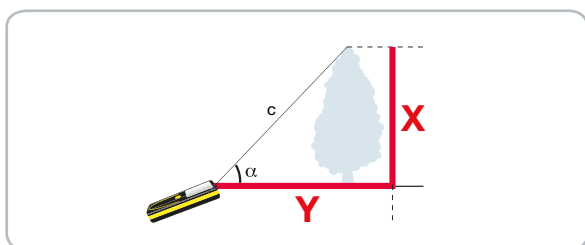

Mod. 61186, 61190, 61114, 61240, 61260, 61060, 61100
FUNZIONE PITAGORA - 1° modalità
 Lo strumento può calcolare la lunghezza di due cateti misurando l'ipotenusa e dell'angolo.

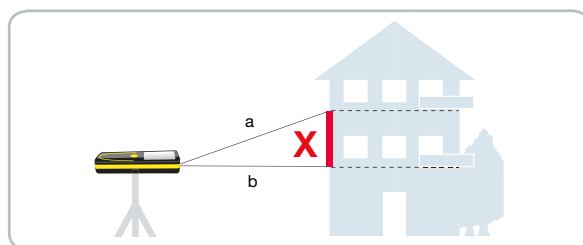

Mod. 61130, 61155, 61186, 61190, 61240, 61260
FUNZIONE PITAGORA - 2° modalità
 Lo strumento può calcolare un cateto misurando l'ipotenusa e la base del triangolo rettangolo.

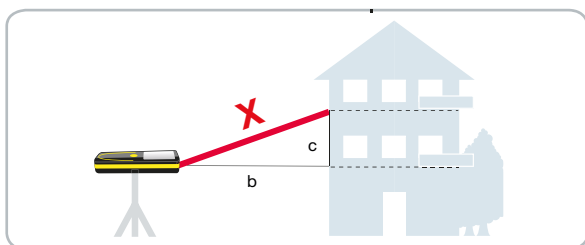

Mod. 61130, 61155, 61186, 61190, 61110, 61114, 61060, 61100
FUNZIONE PITAGORA - 3° modalità
 Lo strumento può calcolare l'ipotenusa misurando i due cateti del triangolo rettangolo

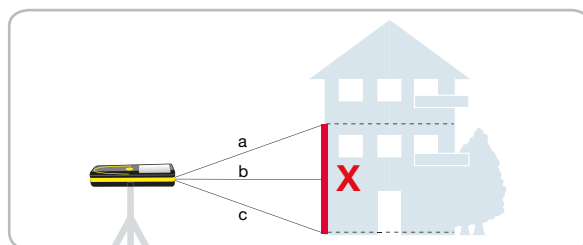

Mod. 61130, 61155, 61186, 61190, 61240, 61260, 61060, 61100
FUNZIONE PITAGORA - 4° modalità
 Doppio pitagora. Lo strumento può calcolare il terzo lato del triangolo misurando le due ipotenuse e l'altezza dei due triangoli

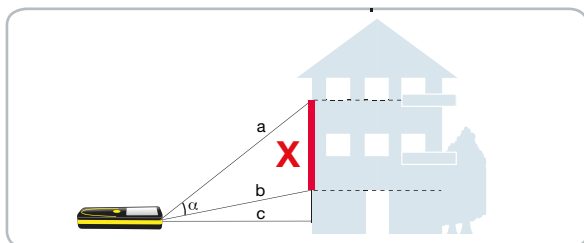

Mod. 61130, 61155, 61186, 61190, 61110, 61114, 61240, 61260, 61060, 61100

FUNZIONE PITAGORA - 5° modalità

Lo strumento può calcolare l'altezza irraggiungibile, misurando le 2 ipotenuse e il cateto di un triangolo rettangolo composto.

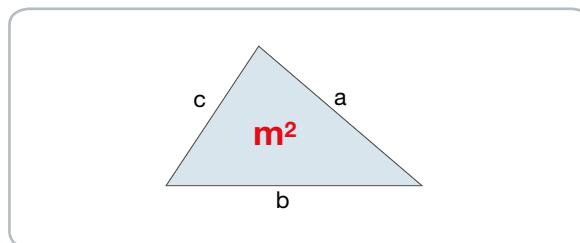

Mod. 61186, 61190, 61240, 61260

FUNZIONE PITAGORA - 6° modalità

Lo strumento può calcolare area del triangolo irregolare misurando la lunghezza dei suoi tre lati.

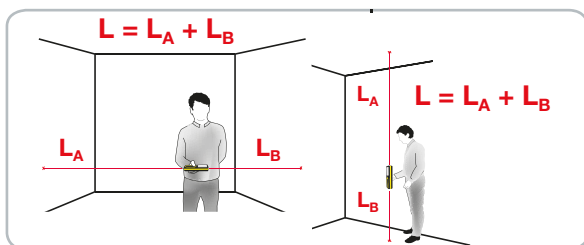

Mod. 61114

FUNZIONE DUAL LASER

Lo strumento può calcolare l'altezza e la larghezza di una stanza senza posizionarsi all'estremità di essa.

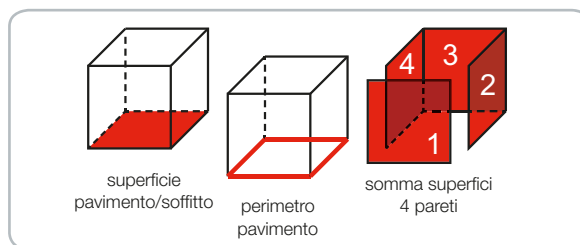

Mod. 61190

FUNZIONE STANZE

Lo strumento può calcolare superficie del pavimento, perimetro dello zoccolino, area delle 4 pareti laterali e volume misurando base, altezza e larghezza della stanza.

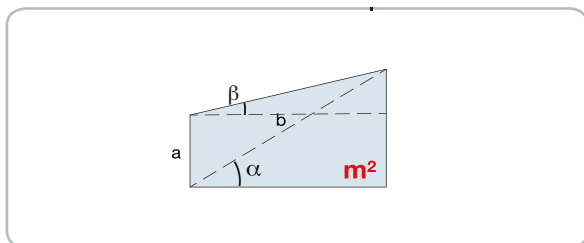

Mod. 61190, 61240, 61260

FUNZIONE TRAPEZIO

Lo strumento può calcolare area del trapezio, dell'angolo α e β misurando base minore e diagonale maggiore.

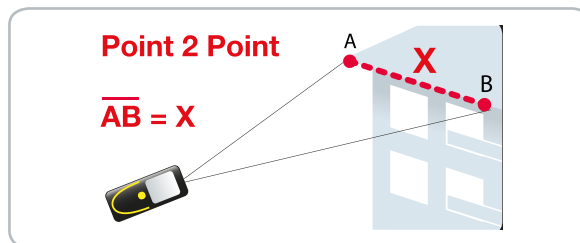

Mod. 61240, 61260

FUNZIONE POINT 2 POINT

Lo strumento può calcolare la distanza di 2 punti su un piano (si consiglia l'utilizzo del cavalletto)

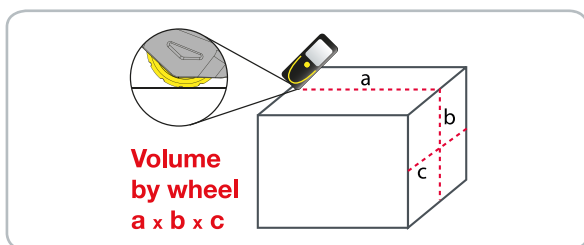

Mod. 61240, 61260

FUNZIONE MISURA CON ROTELLA A CONTATTO

Lo strumento può calcolare il volume di un parallelepipedo utilizzando la rotella per misure lineari a contatto

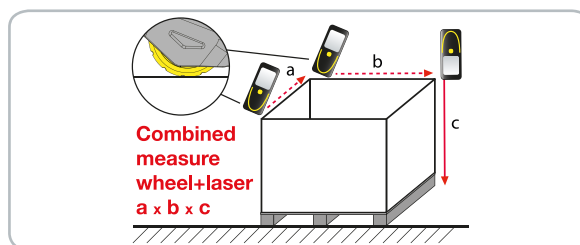

Mod. 61240, 61260

FUNZIONE MISURA CON ROTELLA A CONTATTO E LASER

Lo strumento può calcolare il volume di un parallelepipedo utilizzando laser e rotella combinati

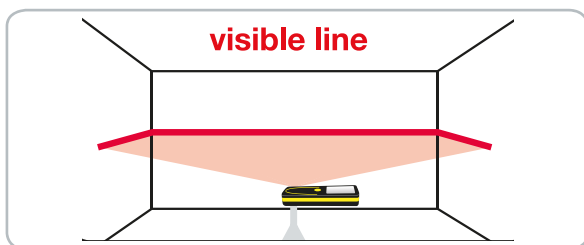

Mod. 61240, 61260

FUNZIONE VISIBLE LINE

Lo strumento proietta una linea fissa per allineamento oggetti.

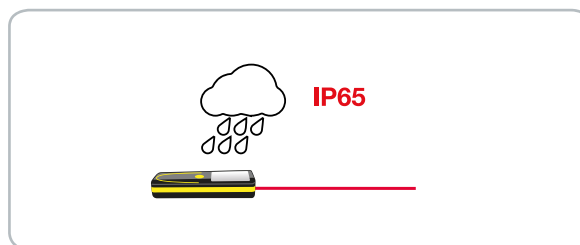

Mod. 61240, 61260

PROTEZIONE IP65

METRICA FLASH MINI 30

Ref.	L	Barcode	Box	€
61110	0,05 ÷ 30 m	8001066611102	1	-



- Display retroilluminato su 4 righe
- Schermo ad alta visibilità
- Funzione misurazione continua con MAX e MIN
- Distanze, superfici, volumi
- 2 funzioni pitagora
- Somma, sottrazione
- 10 memorie
- Autospegnimento
- Con cinghietta
- **Batteria LI-ION ricaricabile**
- In astuccio

CARATTERISTICHE TECNICHE

Portata*	30 m (interna)
Precisione	± 3 mm
Tipo laser	620-690 nm <1mW
Classe laser	classe II
Impermeabilità	IP 54
Temperatura d'esercizio	0° C / 40° C
Batterie	LI-ION
Dimensione (cm)	7,5 x 1,5 x 3,4
Peso (senza batterie)	36 g
Cavetto ricarica	si

* secondo luminosità ambientale

METRICA FLASH GO 15

Ref.	L	Barcode	Box	€
61109	0,05 ÷ 15 m	8001066611096	1	-



- Misura immediata
- Display su 1 riga
- 3 unità di misura mm/inch/ft
- Autospegnimento
- Con cinghietta
- Batteria LI-ION ricaricabile con cavetto incluso

CARATTERISTICHE TECNICHE

Portata*	15 m (interna)
Precisione	± 3 mm
Tipo laser	620-690 nm <1mW
Classe laser	classe II
Impermeabilità	IP 54
Temperatura d'esercizio	0° C / 40° C
Batterie	LI-ION
Dimensione (cm)	7,5 x 1,5 x 3,4
Peso (senza batterie)	36 g
Cavetto ricarica	si

* secondo luminosità ambientale

METRICA FLASH DOUBLE LASER 50 INCLIGRAD

Ref.	L			€
61114	0,05 ÷ 50 m	8001066611140	1	-



- Indica direttamente la misura da cielo a terra
- 2 Laser: uno anteriore + uno posteriore
- Misurazione istantanea della somma dei 2 laser
- + inclinometro
- + schermo rotante
- Possibilità di misurare anche con un solo laser (anteriore o posteriore)
- Display retroilluminato su 4 righe
- Schermo ad alta visibilità
- Funzione misurazione continua con MAX e MIN
- Distanze, superfici, volumi
- 2 funzioni pitagora (misure indirette)
- Somma, sottrazione
- 50 memorie
- Autospegnimento
- Con cinghietta
- **Batteria LI-ION ricaricabile**
- In astuccio

CARATTERISTICHE TECNICHE

Portata *	50 m (interna)
Portata laser anteriore *	30 m
Portata laser posteriore *	20 m
Precisione cadalaser	± 3 mm
Tipo laser	620-690 nm <1mW
Classe laser	classe II
Impermeabilità	IP 54
Temperatura d'esercizio	0° C / 40° C
Batterie	LI-ION
Dimensione (cm)	8,5 x 3,8 x 1,9
Peso (senza batterie)	50 g
Cavetto ricarica	si



* secondo luminosità ambientale

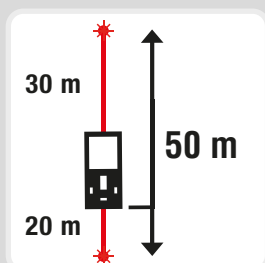

Ref. 89296: 1 pz - EXPO DOUBLE - 6 pz - Ref. 61114



METRICA ONE

Ref.	L			€
61120	0,15 ÷ 30 m	8001066611201	1	-

- Display retroilluminato su 1 riga
- Schermo ad alta visibilità
- Funzione misurazione continua
- Distanze, superfici, volumi
- 1 fiala
- Autospegnimento
- Funzione sonora
- Con cinghietta
- In astuccio



CARATTERISTICHE TECNICHE

Portata*	30 m
Precisione	± 2 mm
Durata	8.000 misurazioni singole
Tipo laser	635 nm <1mW
Classe laser	classe II
Impermeabilità	IP 54
Temperatura d'esercizio	0° C / 40° C
Batterie	1,5 V X 2 AAA
Dimensione (mm)	105 x 46 x 26
Peso (senza batterie)	80 g

* secondo luminosità ambientale

ESPOSITORE DA BANCO UTILIZZABILE PER DISTANZIOMETRI METRICA FLASH

Ref. IMESPFLASH

Dimensioni:
42,5 x 14,5 x 31 mm
dotato di tasca porta flyer



INCLUSO

METRICA FLASH 30 - 60 metri

Ref.	L			€
61130	0,05 ÷ 30 m	8001066611300	1	-
61155	0,05 ÷ 60 m	8001066611553	1	-



- Display retroilluminato su 4 righe
- Schermo nero ad alta visibilità
- Funzione misurazione continua, con valori max/min sempre visualizzati
- 4 funzioni di Pitagora (misure indirette)
- Tracciamento guidato
- Distanze, superfici, volumi
- Somma e sottrazione di distanze, superfici e volumi
- Stelo estraibile per diagonali
- 2 fiale
- Timer di misura, autospegnimento
- Ritardo nella misurazione impostabile
- Funzione sonora
- 99 memorie
- Filetto 1/4" per attacco treppiede
- Con cinghietta, in astuccio

CARATTERISTICHE TECNICHE

Portata Ref. 61130*	30 m
Portata Ref. 61155*	60 m
Precisione	± 2 mm
Durata	8.000 misurazioni singole
Tipo laser	635 nm <1mW
Classe laser	classe II
Impermeabilità	IP 54
Temperatura d'esercizio	0° C / 40° C
Batterie	1.5 V X 2 AAA
Dimensione (mm)	118 x 54 x 28
Peso (senza batterie)	110 g
Filetto per attacco treppiedi	1/4"

* secondo luminosità ambientale

STELO PER DIAGONALE



FORO 1/4 NEL RETRO PER ATTACCO TREPIEDE



1/4"



INCLUSO

METRICA FLASH 100 metri TARGET CAMERA

Ref.	L			€
61186	0,05 ÷ 100 m	8001066611867	1	-



- Target camera, telecamera con mirino per visualizzare il punto dove si sta misurando
- Doppio inclinometro digitale (orizzontale e verticale)
- Fiala elettronica
- Funzione misurazione continua, con valori max/min sempre visualizzati
- 6 funzioni di Pitagora (misura indiretta)
- Tracciamento guidato
- Distanze, superfici, volumi
- Somma e sottrazione di distanze, superfici e volumi
- Squadretta per diagonali
- Timer di misura, autospegnimento
- Ritardo nella misurazione impostabile
- Funzione sonora
- 100 memorie
- Cavetto connessione PC/ricarica
- Batterie ricaricabili
- Filetto 1/4" per attacco treppiede
- Con cinghietta, in astuccio

CARATTERISTICHE TECNICHE

Portata *	100 m
Precisione	± 2 mm
Misurazione angolo	± 90°
Durata	30.000 misurazioni singole
Tipo laser	635nm <1mW
Classe laser	classe II
Impermeabilità	IP 54
Temperatura d'esercizio	0° C / 40° C
Batterie	NiMh 3X1.2V 800mAh
Dimensione (mm)	130 x 56 x 29
Peso (senza batterie)	130 g
Filetto per attacco treppiedi	1/4"

* secondo luminosità ambientale

TARGET CAMERA

- La camera visualizza il punto dove si misura la distanza



SQUADRETTA PER DIAGONALE



DOPIO INCLINOMETRO

FORO 1/4 NEL RETRO PER ATTACCO TREPIEDE



CAVETTO CONNESSIONE PC/RICARICA INCLUSO

METRICA FLASH 120 ZOOM

Ref.	L			€
61190	0,15 ÷ 120 m	8001066611904	1	-



- Telecamera **zoom 4X con mirino**
- **Foto** del punto misurato **con memoria di misura**
- **Video e registrazione vocale con memo**
- Doppio inclinometro digitale (orizzontale e verticale)
- Funzione misurazione continua, con valori max/min sempre visualizzati
- 7 funzioni di Pitagora (misura indiretta)
- Tracciamento guidato
- Distanze, superfici, volumi
- Somma e sottrazione di distanze, superfici e volumi
- Squadretta per diagonali
- 16 GB di memoria interna
- Cavetto connessione PC/ricarica
- **Batterie ricaricabili**
- Filetto 1/4" per attacco treppiede
- Con cinghietta, in astuccio

CARATTERISTICHE TECNICHE

Portata *	120 m
Precisione	± 2 mm
Misurazione angolo	± 90°
Durata	30.000 misurazioni singole
Tipo laser	635nm <1mW
Classe laser	classe II
Impermeabilità	IP 54
Temperatura d'esercizio	0° C / 40° C
Batterie	NiMh 3X1.2V 800mAh
Dimensione (mm)	145 x 60 x 29
Peso (senza batterie)	160 g
Filetto per attacco treppiedi	1/4"
Cavetto connessione	PC / ricarica

* secondo luminosità ambientale



YouTube

CAMERA ZOOM 4X

- Visualizza il punto misurato e la distanza

SQUADRETTA PER DIAGONALE



DOBPIO INCLINOMETRO



CAVETTO CONNESSIONE PC/RICARICA INCLUSO

METRICA POINT 2 POINT 40

Ref.	L	Barcode	Box	€
61240	0,2 ÷ 40 m	8001066612406	1	-
61260	0,2 ÷ 60 m	8001066612604	1	-



* marchio di proprietà del titolare



YouTube

- **Funzione Point 2 Point:** misura la distanza tra 2 punti A e B puntando successivamente A e B
- **Rotella di misura incorporata:** trascinando la rotella si rileva la misura istantanea. Indispensabile per misure di lati senza battuta
- Calcolo di superfici e volumi anche con uso combinato di laser e rotella
- Funzione misurazione continua con MAX e MIN
- **Inclinometro**
- Proietta una linea laser fissa per allineamento oggetti
- Misura: distanze, superfici, volumi, somma, sottrazione, funzioni Pitagora
- Sistema **Bluetooth** e Metrica Plan App per una perfetta integrazione con PC
- Schermo HD da 2,4" con funzione di **auto-rotazione** disattivabile
- **Impermeabilità IP65**
- Batterie ricaricabili
- Filetto 1/4" per attacco treppiedi

CARATTERISTICHE TECNICHE

Portata *	40 m / 60 m
Precisione Tipica	± 2,0 mm + (5XD*10 ⁻⁵)
Precisione Rotella	± 5‰
Letture	1 mm
Tipo laser	630-670 nm <1mW
Classe laser	classe II
Area/Volume	sì
Max/Min	sì
Pitagora	sì
Sottrazione/Addizione	sì
Memoria	50 misure
Impermeabilità	IP 65
Batterie	1,5V. X 3 - AAA ricaricabili con USB-C
Dimensione (mm)	137 x 55 x 26
Peso (senza batterie)	132 g
Filetto per attacco treppiedi	1/4"

* secondo luminosità ambientale



ROTELLA PER MISURE A CONTATTO

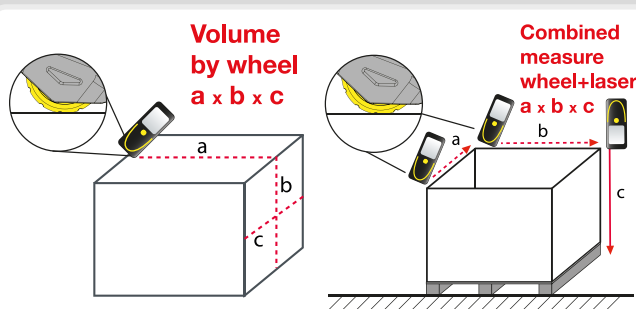

ROTAZIONE SCHERMO



FUNZIONE POINT 2 POINT



LINEA LASER FISSA PER ALLINEAMENTO OGGETTI



CAVETTO CONNESSIONE PC/RICARICA INCLUSO

METRICA GREEN

Ref.	L			€
61060	0,05 ÷ 60 m	8001066610600	1	-
61100	0,05 ÷ 100 m	8001066611003	1	-



- **Laser verde** per una migliore visione
- **Inclinometro digitale**, Fiala elettronica
- Funzione misurazione continua, con valori max/min sempre visualizzati
- 4 funzioni di Pitagora (misura indiretta)
- Distanze, superfici, volumi
- Somma e sottrazione di distanze, superfici e volumi
- Timer di misura, autospegnimento
- Ritardo nella misurazione impostabile
- Funzione sonora: beep
- 99 memorie
- **Batteria ricaricabile** Li-Ion 3,7 V 850 mAh
- Cavetto ricarica
- Filetto 1/4" per attacco treppiede
- Con cinghietta, in astuccio

CARATTERISTICHE TECNICHE

Portata Ref. 61060*	60 m
Portata Ref. 61100*	100 m
Precisione	± 2 mm + (5XD*10 ⁻⁵)
Tipo laser	500-535 nm <1mW
Letture	1 mm
Classe laser	classe II
Impermeabilità	IP 54
Temperatura d'esercizio	0° C / 40° C
Batterie	Li-Ion 3,7 V 850 mAh
Dimensione (mm)	118 x 52 x 27
Peso (senza batterie)	50 g
Cavetto Batteria:	Sì
Filetto per attacco treppiedi	1/4"

* secondo luminosità ambientale



1/4"



FORO 1/4
NEL RETRO
PER ATTACCO
TREPIEDE



INCLIGRAD



BATTERIA
Li-Ion 3,7 V 850 mAh



CAVETTO
CONNESSIONE
PC/RICARICA
INCLUSO



ESPOSITORI PER METRICA FLASH

Ref.	L x H x P		€
EXPO FLASH	30 x 45 x 16 cm	1	-

■ Composizione LIBERA





ESPOSITORE PER Ref. 61110

Ref.	L x H x P			€
89295	18 x 27 x 11 cm	8001066892952	1	-

- Composizione 6 x Ref. **61110** + Ref. **EXPO MINI**
- In omaggio con il primo ordine con minimo 6 pezzi



ESPOSITORE PER Ref. 61114

Ref.	L x H x P			€
89296	18 x 27 x 11 cm	8001066892969	1	-

- Composizione 6 x Ref. **61114** + Ref. **EXPO DOUBLE**
- In omaggio con il primo ordine con minimo 6 pezzi





LEICA DISTO D110

Ref.	L			€
61017	0,2 ÷ 60 m	8001066610174	1	-

- Misurazione in continuo - unico pulsante multifunzione
- Rilievi rapidi: Bluetooth Smart con App gratuita
- Ergonomico - nuova forma - pocket clip rimovibile
- ISO Standard 16331-1
- Funzione: area
- Con clip
- Tascabile
- **Portata fino a 60 m**
- **Precisione: ± 1,5 mm**
- **IP: 54**



* marchio di proprietà del titolare



LEICA DISTO D2 NEW

Ref.	L			€
61008	0,05 ÷ 100 m	8001066610082	1	-

- Design ergonomico e compatto con Soft grip
- Risultati visualizzati su 3 righe
- Illuminazione del display per letture anche al buio
- Misurazione in continuo, con min/max
- Misurazione orizzontale automatica, diagonale automatica
- Tracciamento e memorizzazione dei risultati
- Funzione Pitagora con 2 o 3 misure: determina la distanza nei casi in cui non è possibile effettuare una misura diretta
- Misura di aree e volumi
- X-Range Power Technology
- **Bluetooth smart**
- Squadretta
- **Portata: fino a 100 m**
- **Precisione: ± 1,5 mm**
- **IP: 54**



* marchio di proprietà del titolare



LEICA DISTO X3-1

Ref.	L			€
61029	0,05 ÷ 150 m	8001066610297	1	-

- Portata fino a 150 m
- Funzione P2P
- Bluetooth
- Sensore di inclinazione 360°
- IP 65 ermetico alla polvere e resistente ai getti d'acqua
- Misure di altezze anche senza superfici di riflessione (es. altezza di un albero o di una facciata)
- Rilievi rapidi: Bluetooth Smart con App gratuita
- Ergonomico
- Robustissimo e facile da pulire
- ISO Standard 16331-1



* marchio di proprietà del titolare



LEICA DISTO X4-1

Ref.	L			€
61014	0,05 ÷ 150 m	8001066610143	1	-

- Portata fino a 150 m
- fotocamera con mirino + zoom x4
- Display a colori
- Funzione P2P
- Bluetooth
- Sensore di inclinazione 360°
- IP 65 ermetico alla polvere e resistente ai getti d'acqua
- Misure di altezze anche senza superfici di riflessione (es. altezza di un albero o di una facciata)
- Rilievi rapidi: Bluetooth Smart con App gratuita
- Ergonomico
- Robustissimo e facile da pulire
- ISO Standard 16331-1



* marchio di proprietà del titolare



LEICA DISTO D510

Ref.	L			€
61007	0,05 ÷ 200 m	8001066610075	1	–
61031	0,05 ÷ 200 m	8001066610310	1	–

- Puntamento semplice con Mirino digitale Zoom 4X anche con poca luce
- **Sensore di inclinazione 360°**
- Misure di altezze **anche senza superfici di riflessione** (es. altezza di un albero o di una facciata)
- Rilievi rapidi: Bluetooth Smart con App gratuita
- Ergonomico
- Robustissimo e facile da pulire
- **IP 65: ermetico alla polvere e resistente ai getti d'acqua**
- ISO Standard 16331-1
- **Portata: fino a 200 m**
- **Precisione: ± 1,0 mm**



* marchio di proprietà del titolare



KIT PROPACK D510

Ref. **61031**

Comprende:

- dispositivo DISTO D510
- custodia robusta con inserto
- treppiede TRI 70
- adattatore treppiede ad alta precisione FTA 360



LEICA DISTO D810 TOUCH

Ref.	L			€
61015	0,05 ÷ 200 m	8001066610150	1	-
61023	0,05 ÷ 200 m	8001066610235	1	-

- Puntamento semplice con Mirino digitale Zoom 4X anche con ridotta luminosità
- **Overview Camera**
- **Touchscreen**
- **Sensore di inclinazione 360°**
- **Misura di altezze anche senza superfici di riflessione (es. altezza di un albero o di una facciata)**
- **Rilievi rapidi: Bluetooth Smart con App gratuita**
- Ergonomico
- Robustissimo e facile da pulire
- **Batterie Li-Ion**
- ISO Standard 16331-1
- **Portata fino a 200 m**
- **Precisione: ± 1,0 mm**
- **IP: 54**



* marchio di proprietà del titolare



KIT PROPACK D810 TOUCH

Ref. **61023**

Comprende:

- dispositivo DISTO D810 touch
- custodia robusta con inserto
- treppiede TRI 70
- adattatore treppiede ad alta precisione FTA 360



LEICA DISTO S910

Ref.	L			€
61010	0,05 ÷ 300 m	8001066610105	1	-
61012	0,05 ÷ 300 m	8001066610129	1	-

- **Misura la distanza tra due punti**
- Puntamento semplice con Mirino digitale Zoom 4X anche con ridotta luminosità
- **Overview Camera**
- **Touchscreen**
- **Sensore di inclinazione 360°**
- **Misura di altezze anche senza superfici di riflessione (es. altezza di un albero o di una facciata)**
- **Rilievi rapidi: Bluetooth Smart con App gratuita**
- Ergonomico
- Robustissimo e facile da pulire
- **Batterie Li-Ion**
- ISO Standard 16331-1
- **Portata fino a 300 m**
- **Precisione: ± 1,0 mm**
- **IP: 54**
- **P2P technology**
- **Capture data in CAD format**
- **X-Range Power Tech**



* marchio di proprietà del titolare



KIT PROPACK S910

Ref. **61012**

Comprende:

- dispositivo S910
- treppiede TR170
- piastra segnale GZM3
- borsa di trasporto
- nuovo FTA360-S



TREPPIEDE LEICA TRI100

Ref.	L			€
60571	70 ÷ 172 cm	8001066605712	1	-

- Treppiede foto/video (altezza 1,72 m) di **alta qualità** e con semplicissime **regolazioni di precisione**
- Testa con elevazione a manovella, gambo centrale a blocco frizionato
- Piedini in gomma regolabili in altezza e adattabili a qualsiasi superficie
- Completo di testa snodabile (filetto 1/4") e sistema di ribaltamento a 90° (Pitagora)
- Completo di sacca di trasporto con tasca esterna portaoggetti
- Ideali per tutti i Leica DISTO (no Leica DISTO D1/D110/D2 NEW)
- **Peso: 2,4 Kg**



LEICA DIGICAT DD120

Ref.			€
61930	8001066619306	1	-

- **Localizzatore di servizi**
- I localizzatori di cavi della serie Leica DD100 sono dotati di **controlli automatici avanzati** che rendono la serie DD100 facile da usare, richiedendo un'esperienza minima da parte dell'utente. Evitare i cavi e i tubi sotterranei cavi e tubi sotterranei è una delle principali preoccupazioni nei cantieri.
- Pertanto, il rilevamento della posizione di cavi e tubi interrati prima dei lavori di scavo può aiutare a prevenire lesioni all'operatore, i danni ai beni e i costi successivi. Utilizzate i localizzatori di cavi DD120 in combinazione con un trasmettitore di segnale DA220 trasmettitore di segnale o una gamma di accessori per ottenere una migliore accuratezza e la portata dell'applicazione.
- **Con la funzione Automatic Pinpointing** non c'è bisogno di regolare manualmente la sensibilità del vostro localizzatore di cavi Digicat assicurandovi di usare la sensibilità ottimale per l'ambiente ambiente in cui si stanno rilevando i servizi sotterranei. Riducendo la probabilità di errore umano e consentendo una più facile e più efficiente localizzazione di cavi e tubi. In definitiva, risparmiando tempo e denaro.

CARATTERISTICHE TECNICHE

Potenza modello	50Hz o modello 60Hz
Radio	da 15kHz a 60kHz
Auto	Power, Radio, 33kHz
Modalità del trasmettitore	32.768 (33) kHz / 8.192 (8) kHz
Gamma di profondità	linea 0.3m a 3m / 1ft a 10 ft
Precisione della profondità *	10%
Impermeabilità	IP 54
Temperatura di funzionamento	da -20° C a +50° C
Durata batteria**	15 ore
Dimensione (mm)	760 x 250 x 85
Peso (con batterie)	2,7 Kg

* Profondità di un segnale non distorto

** Uso costante a 20°C/68°F



**TERMOCAMERA FLIR
SERIE Ext WIFI***

Ref.			€
60435	8001066604357	1	-
60436	8001066604364	1	-
60438	8001066604388	1	-

- **Termocamera** ad infrarossi serie FLIR Ext WiFi
- Funzione di miglioramento dell'immagine MSX
- Connettività wireless agli smartphone e ad altri dispositivi.
- Campo visivo di 45° x 34°
- PIP (E6 ed E8)
- Leggero (575 gr) e robusto
- **Protezione anticaduta: 2 m**
- **60435 - E5xt WIFI**
 - Risoluzione infrarosso 19.200 pixels (160 x 120)
 - Sensibilità termica < 100 mk (< 0,10 °C)
 - Intervallo di temperatura da - 20°C a + 400°C
- **60436 - E6xt WIFI**
 - Risoluzione infrarosso 43.200 pixels (240 x 180)
 - Sensibilità termica < 60 mK (< 0,06 °C)
 - Intervallo di temperatura da - 20°C a + 550°C
- **60438 - E8xt WIFI**
 - Risoluzione infrarosso 76.800 pixels (320 x 240)
 - Sensibilità termica < 50 mK (< 0,05 °C)
 - Intervallo di temperatura da - 20°C a + 550°C
- Batteria al di litio ricaricabile 3.7 V, autonomia circa 4 ore. Tempo di ricarica 2 ore tramite caricabatterie o 2,5 ore al 90% all'interno della termocamera.
- **Scarica le immagini via USB**
- **Connettività WIFI** verso tablet, smartphone e altri dispositivi



* marchi di proprietà del titolare

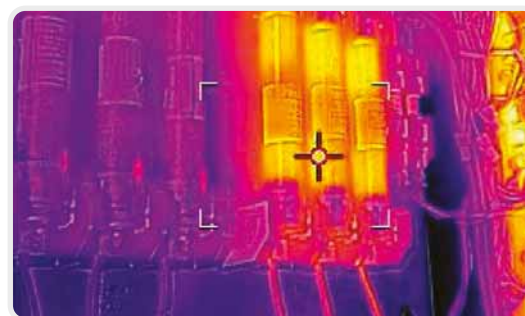



TERMOCAMERA FLIR TG267

Ref.			€
60424	8001066604241	1	-

- Campo di misura da -25° C fino a 380° C
- Funzione MSX
- Macchina fotografica da 19.200 pixel
- Bluetooth
- Memoria: 50.000 immagini
- Batteria ricaricabile agli ioni di litio
- Resistente alle cadute da 2 m
- Torcia a LED integrata

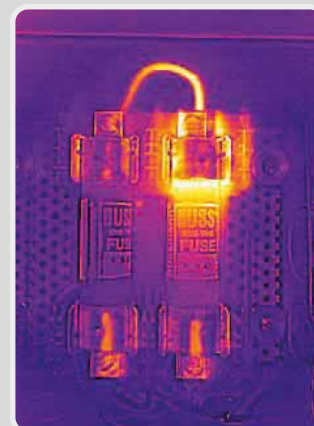
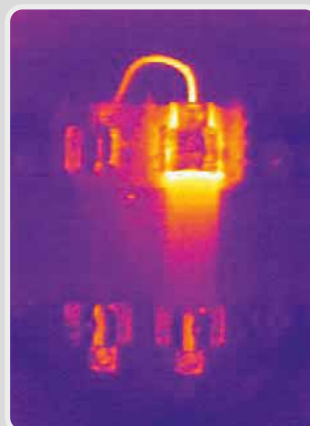

INFRARED GUIDED MEASUREMENT



* marchi di proprietà del titolare



 **YouTube**



TERMOCAMERA FLIR TG165-X

Ref.	Barcode	Box	€
60394	8001066603947	1	-

- Termometro ad immagine ad infrarossi TG 165-X
- Funzione MSX
- Campo di misura da -25° C a +300 °C
- Schermo LCD da 2.4" con 3 scale di colori
- Risoluzione display 320x240 pixel
- Supporti di memorizzazione 4 GB (50.000 immagini)
- Protezione anticaduta: 2 m
- Filetto per treppiede da 1/4"



* marchi di proprietà del titolare



FLIR
01



RILEVATORE DI TENSIONE FLIR VP42

Ref.	Barcode	Box	€
70099	8001066700998	1	-

- Senza contatto: vibrazione e LED
- Lampada LED potenza 60 lumen
- Protezione anticaduta: 3 m
- Tensioni fino a 1000 V





TERMOCAMERA FLIR C3-X / C5

Ref.			€
60393	8001066603930	1	-
60395	8001066603954	1	-



Ref. **60393**- FLIR C3-X

- Schermo touch screen da 3" intuitivo
- Risoluzione 128 x 96 pixel (12.288 pixel)
- Campo di misura da -20° C a +300 °C
- Funzione MSX: immagine reale e infrarossi combinato
- Flir Tools Software incluso
- **Wi-Fi**
- Memoria 5.000 immagini



Ref. **60395**- FLIR C5

- Schermo touch screen da 3" intuitivo
- Risoluzione 160 x 120 pixel (19.200 pixel)
- Campo di misura da -20° C a +400 °C
- Funzione MSX: immagine reale e infrarossi combinato
- Flir Tools Software incluso
- **Wi-Fi**
- Memoria 5.000 immagini



* marchi di proprietà del titolare



YouTube





**TERMOCAMERA FLIR
ONE Pro - ONE Pro LT**



Ref.				€
60399	Pro	8001066603992	1	-
60400	Pro	8001066604005	1	-
60401	Pro	8001066604012	1	-
60396	Pro LT	8001066603961	1	-
60397	Pro LT	8001066603978	1	-
60398	Pro LT	8001066603985	1	-

- FLIR ONE PRO **collegata al telefono cellulare** (60397 e 60399 - IOS , 60398 e 60400 - Micro USB, 60396 e 60401 - USB-C), consente di individuare ancora più velocemente i problemi non visibili a occhio nudo.
- Campo di misura: ONE Pro da -20 a +400°C - ONE Pro LT da -20 a +120°C
- Risoluzione termica: ONE Pro 19.200 pixels 160 x 120 - ONE Pro LT 4.800 pixels 80 x 60
- Risoluzione fotocamera digitale 1440 x 1080
- Formati file: Foto: JPEG, Video: MPEG-4
- Protezione anticaduta: 1,8 m



* marchi di proprietà del titolare





MULTIMETRO FLIR DM166

Ref.	Barcode	Box	€
70803	8001066708031	1	-

- **Immagine termica con IGM** a 19200 pixel
- 18 funzioni: come la modalità VFD, valori RMS, LoZ, Tensioni senza contatto
- Campo di misura da -10 a +150 °C
- Voltaggio AC/DC: 1000 V
- **Puntatore laser**
- Ingresso termocoppia
- Illuminazione integrata
- Bluetooth
- **Protezione anticaduta: 3 m**



Puntatore laser

* marchi di proprietà del titolare



MULTIMETRO FLIR DM285

Ref.	Barcode	Box	€
70804	8001066708048	1	-

- **Immagine termica con IGM** a 4800 pixel
- 18 funzioni: come la modalità VFD, valori RMS, LoZ, Tensioni senza contatto
- Campo di misura da -10 a +150 °C
- Voltaggio AC/DC: 600 V
- **Puntatore laser**
- Ingresso termocoppia
- Illuminazione integrata
- **Protezione anticaduta: 3 m**





**PINZA AMPEROMETRICA
FLIR CM275**

Ref.			€
70801	8001066708017	1	-

- Sensore termico Lepton a 19200 pixel
- Campo di misura da -10 a +150 °C
- Misura della tensione e della corrente (RMS)
- Risolve velocemente i problemi, tra cui True, RMS, LoZ, modalità VFD
- Bluetooth
- Display grafico TFT a colori maggiorato a 2,4"
- **Protezione anticaduta: 2 m**



**PINZA AMPEROMETRICA
FLIR CM174**

Ref.			€
70800	8001066708000	1	-



- Sensore termico Lepton 4800 pixel
- Misura della tensione e della corrente (RMS)
- Risolve velocemente i problemi, tra cui True RMS, LoZ, modalità VFD

* marchi di proprietà del titolare

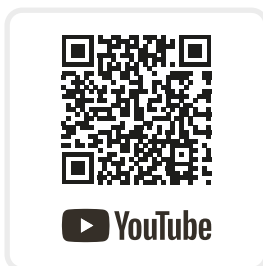



TERMOIGROMETRO FLIR MR176



Ref.			€
60408	8001066604081	1	-

- **Termoigrometro ad immagine ad infrarossi MR176**
- Misurazione con e senza puntali
- Campo di misura igrometro:
 - Umidità relativa da 0 a 100 %
 - Temperatura aria da 0 a 50 °C ±0,6 °C
 - Punto di rugiada da -30 a 50 °C
 - Pressione vapore da 0,0 a 12,0 kPa
- **Display grafico TFT a colori** da 2,3" (320 x 240 pixel) QVGA 4800 pixel





**TERMOIGROMETRO
FLIR MR160**

Ref.			€
60405	8001066604050	1	-



- Immagine termica con IGM
- Sensore umidità senza contatto
- Con la sonda a puntale esterna
- Campo di misura da 0 a 100% WME (± 5%)
- Puntatore laser

* marchi di proprietà del titolare



FLIR

01



**MISURATORE UMIDITÀ
FLIR MR55**

Ref.			€
60423	8001066604234	1	-



- Misurazione di umidità relativa e temperatura
- Il display retroilluminato
- La funzione di mantenimento dati fissa la lettura visualizzata
- Rilevazione di 11 gruppi di materiali, tra cui legname, cartongesso e calcestruzzo
- Bluetooth® consente di visualizzare le misurazioni da un dispositivo mobile.
- Resistenza caduta 2 m

* marchio di proprietà del titolare





MISURATORE FLIR MR59



Ref.			€
60425	8001066604258	1	-

- Sensore sferico (senza punte) per misure non distruttive
- Misurazioni veloci su tutti i tipi di superfici
- Fino a 10 cm di profondità
- Misurazioni in angoli e aree scarsamente illuminate possibili grazie alla sua luce di lavoro
- Display HD per una facile lettura e chiarezza
- Connessione Bluetooth e compatibile con l'applicazione FLIR Tools® Mobile



PENNA UMIDITÀ FLIR MR40

Ref.			€
70110	8001066701100	1	-



- Misuratore di umidità a 2 puntali per legno ed altri materiali da costruzione
- **Indicazione acustica** del range misurato (5-12 %, 13-60 %, oltre 60 %)
- Display LCD
- Lampada LED potenza 40 lumen
- **Protezione anticaduta: 3 m**

MISURATORE DUREZZA SHORE A



Ref.	SHORE A			€
60216	0 ÷ 100	8001066602162	1	-

- Misuratore di durezza per gomma
- Lettura diretta a quadrante
- Shore A 0-100
- Con base
- In astuccio

10

SCLEROMETRO

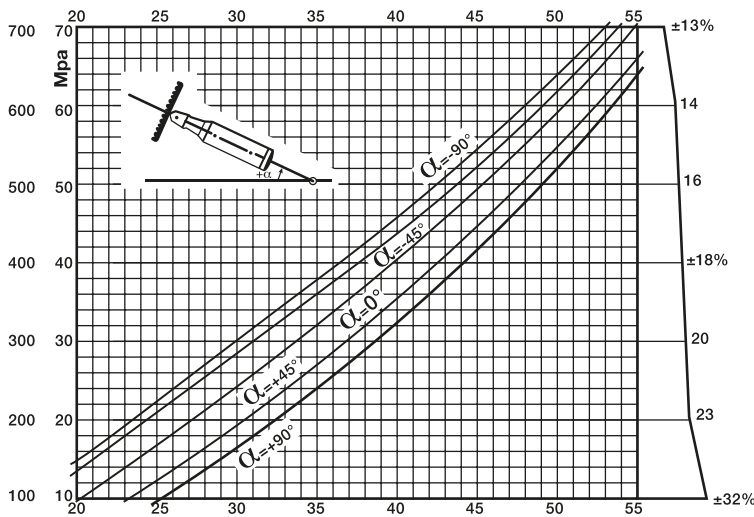

Ref.			€
60210	8001066602100	1	-

- **Sclerometro per calcestruzzo**
- Lettura della resistenza in kg/cm²
- Fornito con provino
- Astuccio rigido

MADE IN ITALY

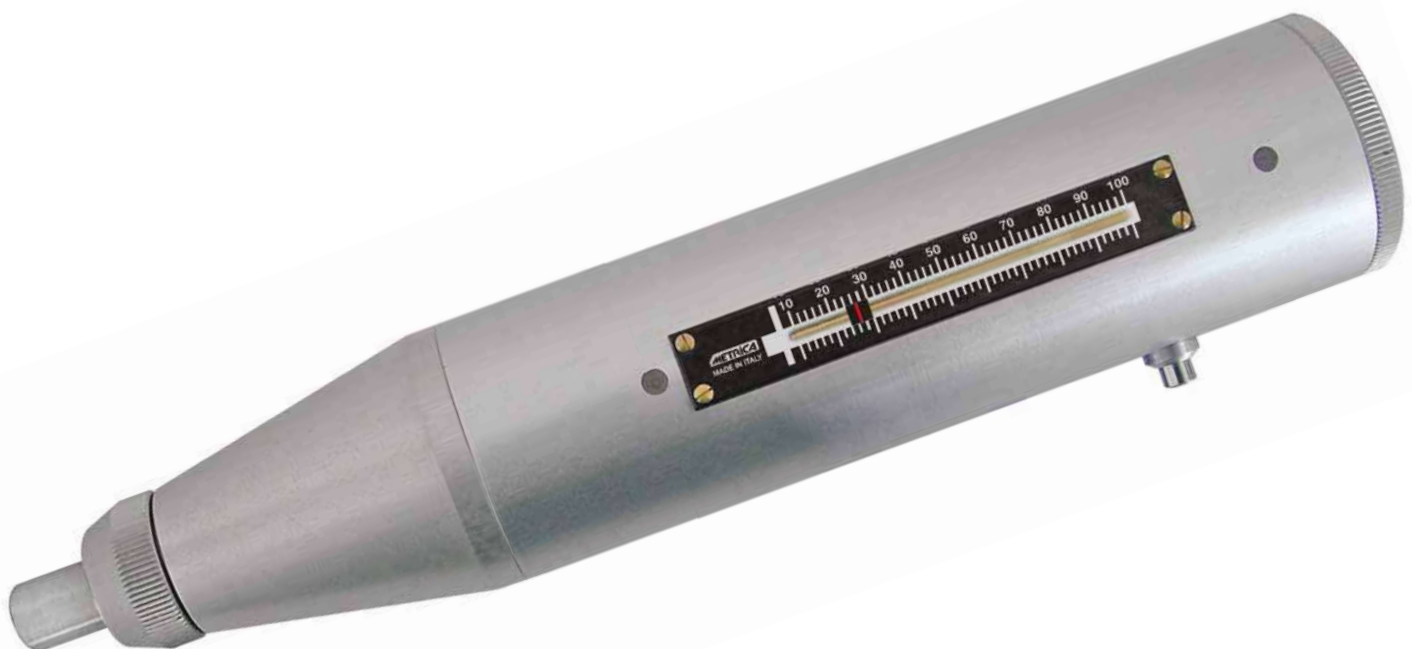



LIVELLA ELETTRONICA



RILEVATORE PROFESSIONALE

Ref.			€
61530	8001066615308	1	-

- **Rilevatore** di metalli, legno e cavi elettrici
- Indicazione della **profondità di rilevazione**:
 - Ferro 100 mm
 - Legno 20 mm
 - Cavi in tensione 50 mm
- **Livella elettronica con inclinometro**

CAVI ELETTRICI



FERRO



LEGNO



METALLI





METAL DETECTOR

Ref.			€
60282	8001066602827	1	-

- Modalità operative: **all metal, monete, piccola minuteria**
- Indicatore del Target: Analogico e Audio - presa jack per auricolari (non forniti)
- Sensibilità: profondità massima: 16 cm in modalità ALL METAL
- **Piatto di ricerca diametro 170 mm**, impermeabile
- Alimentazione: 2 batterie da 9V
- Manico telescopico per un facile trasporto





TERMOMETRO AD INFRAROSSI

Ref.	T °			€
60290	-50 °C / 850 °C	8001066602902	1	-

- Capacità: -50 °C / 850 °C
- Termometro a raggi infrarossi, **doppio laser di puntamento**
- Emissibilità regolabile
- Campo visivo D/S = 12:1 (D=distanza, S=target)
- Per uso industriale
- Risoluzione: 0,1°C
- Umidità relativa: 10 - 90% RH
- Batterie: 1 x 9 V



TERMOANEMOMETRO

Ref.	T ° max			€
60291	60°	8001066602919	1	-

- Misura **Temperatura e Velocità dell'Aria**
- Velocità dell'aria in: m/s, ft/min, km/h, MPH e nodi
- Misurazione della temperatura in °C o °F
- Funzione di blocco del valore misurato e valore massimo (**HOLD**)
- Indicatore di Batteria scarica
- Autospegnimento
- Completo di batteria 9 V e di astuccio





TACHIMETRO DIGITALE A CONTATTO

Ref.					€
70023	x / y	0 ÷ 30.000	8001066700233	1	-

- Tipo a contatto
- Lettura digitale a 5 cifre
- Campo di misura: da 0,2 a 30.000 giri/minuto
- Selezione automatica del punto decimale
- Attacco predisposto per sonda ottica
- Precisione:
 - ± 0,1 giri/min fino a 1.000 giri/min
 - ± 0,005% ± 1 digit da 1.000 a 30.000 giri/min
- Alimentazione: 4 pile stilo 1,5 V (20 h funzionamento continuo)
- Fornito con 2 puntalini conici + 1 puntalino svasato e ruota di rilevazione velocità lineari
- In valigetta antiurto

= giri al minuto



TACHIMETRO DIGITALE OTTICO

Ref.					€
70029	x / y	0 ÷ 100.000	8001066700295	1	-

- Tipo ottico
- Lettura digitale a 5 cifre
- Rilievo istantaneo della velocità angolare
- Campo di misura: da 2 a 100.000 giri/minuto
- Selezione automatica del punto decimale
- Precisione:
 - ± 0,1 giri/min fino a 1.000 giri/min
 - ± 0,005% ± 1 digit da 1.000 a 100.000 giri/min
- In valigetta antiurto corredata di 5 catatarinfrangenti adesivi

= giri al minuto



Fig. A



Fig. B



MISURATORE DI UMIDITÀ

Ref.			€
60274	8001066602742	1	-

- Misuratore d'umidità
- Per misurare su legno e cemento
- Doppia possibilità di misura:
 - Misure superficiali (a contatto) - Fig. A
 - Misure in profondità con sonda (inclusa) - Fig. B
- In valigetta





SPESSIMETRO DIGITALE PER MATERIALI A ULTRASUONI

Ref.	A mm	mm			€
60286	1,5 ÷ 200	0,1	8001066602865	1	-

- Per misurare lo spessore di metalli, vetro e plastica
- Superfici piane o curve
- Fornito con sonda separata e cavo estensibile
- Risoluzione: 0,1 mm
- Campo di misura: 1,5 ÷ 200 mm
- Lettura: mm/inch
- In valigetta



MISURATORE ELETTRONICO DI SPESSORE PER RIVESTIMENTI FE - NFE

Ref.			€
60271	8001066602711	1	-

- Misura istantaneamente lo spessore di vernici o rivestimenti su:
 - superfici metalliche ferrose (FE)
 - superfici metalliche non ferrose (NFE)
- Fornito con sonda di rilevamento e cavo
- Campo di misura: 0 ÷ 1250 μ
- Risoluzione: 0,1μ fino a 100μ. 1μ oltre 100μ
- Precisione: ±1 - 3% o 2,5 μ su 0,1 mil (il valore più elevato)
- Calibrazione semplice e veloce con i 4 campioni di riferimento (50-100-200-500 μ)

Non in vendita in Germania, Francia, UK e USA



FONOMETRO MULTIFUNZIONE

Ref.			€
60294	8001066602940	1	-

- Misura: Lp - Leq - Ln
- Risoluzione: 0,1 db
- Precisione: ± 1 db
- In valigetta

Non in vendita in Germania, Francia, UK e USA

Lp: 30 ~ 130 db (A); 35 ~ 130 db (B); 40 ~ 130 db (C)

Leq: 30 ~ 130 db (10s, 1min, 5min, 10min, 15min, 30min, 1h, 8h, 24h)

Ln: 0 - 100%

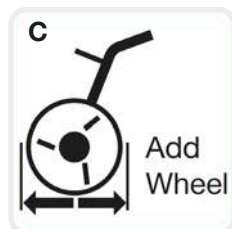
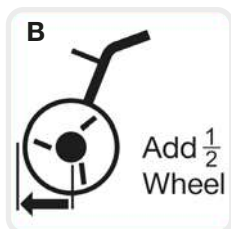
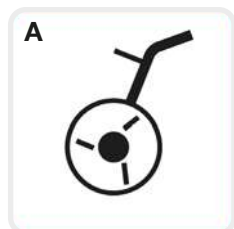

MISURATORE STRADALE ELETTRONICO

Ref.	L			☐	€
60459	10 km	1 cm	8001066604593	1	-

- Display LCD (cristalli liquidi) posto sulla parte superiore del manico per una lettura facilitata
- Contatore 6 cifre
- Capacità 10 km, lettura m/cm
- Lettura 1 cm
- Funzione HOLD di memoria
- Ruota Ø 29 cm
- Spegnimento automatico dopo 3 minuti
- 3 modalità di misura: A - B - C
- Manico telescopico
- Sacca di trasporto
- 8 memorie
- Calcolo area
- m/pollici/Feet/miglia/yard/m/km
- Batterie 2 x AA
- Peso 1,5 kg
- Autonomia 5 ore
- Regolazione contrasto monitor

MISURATORE STRADALE ELETTRONICO JUNIOR

Ref.	L			☐	€
60458	999,9 m	10 cm	8001066604586	1	-

- Display LCD (cristalli liquidi) posto sulla parte superiore del manico per una lettura facilitata
- Contatore 4 cifre
- Capacità 999,9 m, lettura m/10 cm
- Lettura 10 cm
- Funzione HOLD di memoria
- Ruota Ø 30 cm
- Spegnimento automatico
- 2 modalità di misura: A - B
- Manico pieghevole
- Sacca di trasporto
- Calcolo area, volume
- m/Feet//yard
- Batterie 4 x AAA
- Peso 2 kg

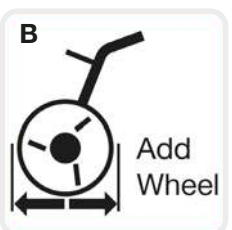
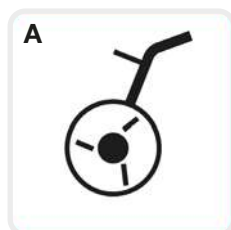
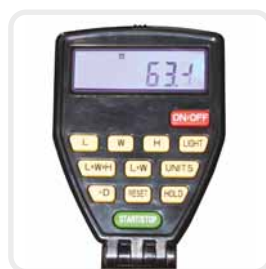



MISURATORE STRADALE CON RUOTA METALLICA

Ref.	L	-----	-----	-----	€
60500	9999,99 m	1 cm	8001066605002	1	—
60502	9999,99 m	1 cm	8001066605026	1	—

- Circonferenza 1 m
- Con bloccaggio
- Contametri a 5 cifre con azzerramento
- Capacità 10 km - lettura 1 cm
- Manico metallico snodato pieghevole
- In valigetta

Ref. **60502** con totalizzatore



MISURATORE STRADALE

Ref.	L	-----	-----	-----	€
60464	10 km	m / 10 cm	8001066604647	1	—

- Contatore visibile ed azionato dall'alto
- Capacità 10 km
- Lettura m/10 cm
- Con freno
- Sezione robusta
- Manico pieghevole
- Ruota Ø 32 cm
- In sacca da trasporto

MINI MISURATORE STRADALE

Ref.	L	-----	-----	-----	€
60453	9999,9 m	10 cm	8001066604531	1	—

- Ingombro ridotto: 41 cm (chiuso)
- 2 ruote Ø 10 cm
- Lettura 10 cm
- Contatore 5 cifre
- Manico telescopico



FESSURIMETRO PIEGHEVOLE UNIVERSALE

Ref.	A/B mm	┌┐┌┐	▣	☞	€
40090	± 10 / ± 20	mm	8001066400904	1	-

- Fessurimetro con 3 + 3 elementi snodabili
- Doppia scala millimetrata
- Graduazione orizzontale ± 20 mm e verticale ± 10 mm
- **Si adatta a qualsiasi parete**, sporgenza, rientranza o superficie curva



FESSURIMETRO PER SUPERFICI PIANE

Ref.	A/B mm	┌┐┌┐	▣	☞	€
40086	± 10 / ± 20	mm	8001066400867	1	-

- Scala millimetrata per misura diretta

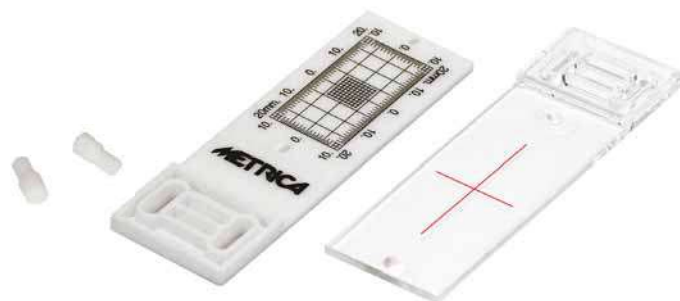

FESSURIMETRO AD ANGOLO

Ref.	A/B mm	┌┐┌┐	▣	☞	€
40091	± 10 / ± 20	mm	8001066400911	1	-

- Scala millimetrata per misura diretta



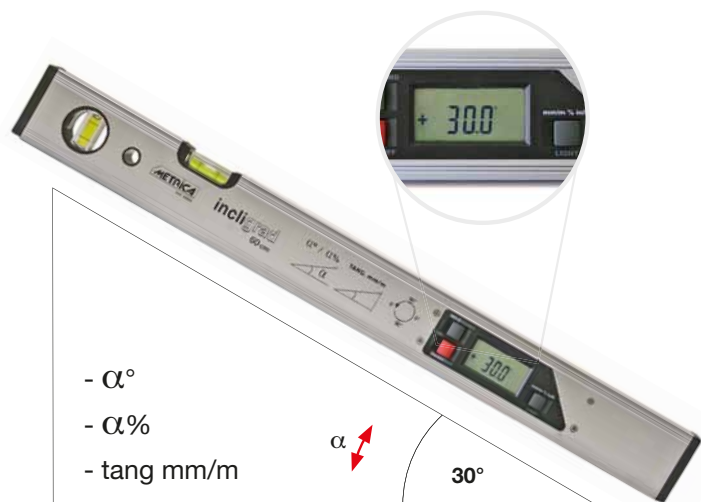

LIVELLA DIGITALE

Ref.	L				€
33806	60 cm	0°- 90°- 0°	8001066338061	1	-
33810	100 cm	0°- 90°- 0°	8001066338108	1	-

- **Letture digitali in gradi (0,05°) in % (0,1%) e funzione tangente (mm/m) schermo retroilluminato**
- **Pulsante di blocco della misura**
- Segnale acustico
- Due fiale acriliche: orizzontale e verticale
- Borsa trasporto

digigrad



MISURATORE DIGITALE D'ANGOLI

Ref.	L					€
29790	50 cm	0-200°	0,1°	8001066297900	1	-

- **Letture digitali 0,1°**
- Due fiale acriliche: orizzontale e verticale
- Due bracci in alluminio incernierati ad incastro



MISURATORE DIGITALE D'ANGOLI

Ref.	L					€
29890	50 cm	0-225°	0,05°	8001066298907	1	-

- Due bracci in alluminio incernierati ad incastro
- **Letture digitali 0,05° - schermo retroilluminato**
- **Pulsante di blocco della misura**
- Funzioni: angolo composto, angolo supplementare
- Due fiale acriliche: orizzontale e verticale
- Borsa trasporto



quadranfix™
Made in Italy



**GONIOMETRO A QUADRANTE
BRACCI AD INCASTRO**

Ref.	L					€
29900	45 cm	0-180°	1°	8001066299003	1	-
29901	60 cm	0-180°	1°	8001066299010	1	-
29903	75 cm	0-180°	1°	8001066299034	1	-
29902	100 cm	0-180°	1°	8001066299027	1	-
29904	150 cm	0-180°	1°	8001066299041	1	-

- **Due bracci** in alluminio **incernierati ad incastro** con bloccaggio a vite
- **Letture in gradi sul quadrante posto frontalmente**
- Capacità 0-180°
- Due fiale acriliche: orizzontale e verticale
- Due punte asportabili in acciaio temprato per uso compasso, riporti o tracciature
- In astuccio

MADE IN ITALY



Uso compasso per riportare lunghezze

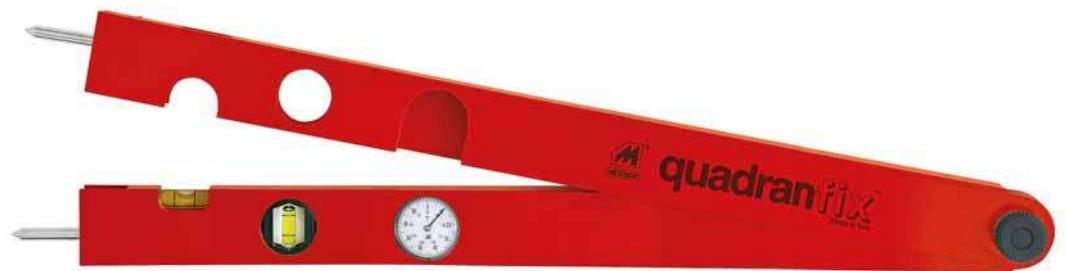

2 fiale acriliche



Quadrante
0°-90° e 90°-180°



Bloccaggio a vite

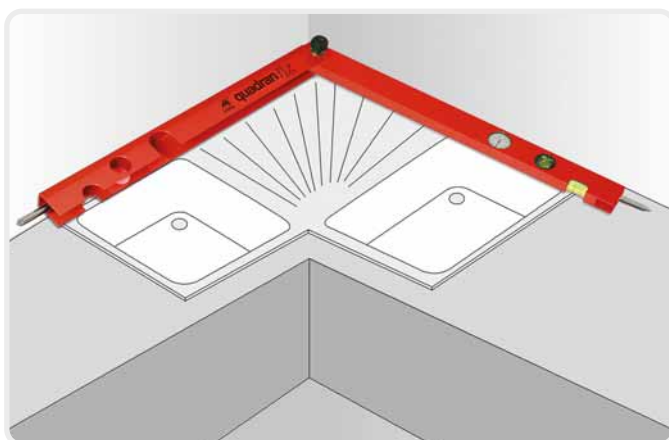

quadranfix™
Made in Italy



**GONIOMETRO A QUADRANTE
BRACCI AFFIANCATI**

Ref.	L					€
29905	60 cm	0-355°	1°	8001066299058	1	-

- **Due bracci** in alluminio incernierati ed **affiancati** con bloccaggio a vite
- **Lettura in gradi sul quadrante posto frontalmente**
- Capacità 0-355°, doppia scala 0-90° e 90°-180°
- Due fiale acriliche: orizzontale e verticale
- Due punte asportabili in acciaio temprato per uso compasso
- In astuccio

MADE IN ITALY



quadranfix™
Made in Italy



**GONIOMETRO A QUADRANTE
BRACCI AFFIANCATI CON MAGNETE**

Ref.	L					€
29915	60 cm	0-355°	1°	8001066299157	1	-

- **Base magnetica**
- Due bracci in alluminio incernierati ed affiancati con bloccaggio a vite
- **Lettura in gradi sul quadrante posto frontalmente**
- Capacità 0-355°, doppia scala 0-90° e 90°-180°
- Due fiale acriliche: orizzontale e verticale
- Due punte asportabili in acciaio temprato per uso compasso
- In astuccio

MADE IN ITALY



telefix™

Made in Italy

TELEFIX METRO-TELESCOPICO



Ref.						€
49358	1 m	32 cm	mm	8001066493586	1	-
49359	2 m	49 cm	mm	8001066493593	1	-
49360	3 m	66 cm	mm	8001066493609	1	-
49361	4 m	83 cm	mm	8001066493616	1	-
49362	5 m	99 cm	mm	8001066493623	1	-
49363	6 m	116 cm	mm	8001066493630	1	-
49365	8 m	135 cm	mm	8001066493654	1	-
49366	10 m	163 cm	mm	8001066493661	1	-

Piattello adatto per misure interne ed esterne.
Spessore 5 mm

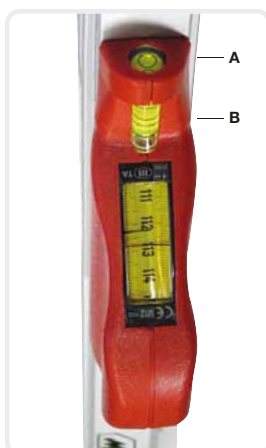

Cassa forma ergonomica.
Finestrella con due fiale incorporate (A e B)



Guaina impermeabile (brevettata) per lavorare anche su fondo bagnato o sabbioso



- Misuratore telescopico professionale a LETTURA DIRETTA SU NASTRO GRADUATO con indicazione di misure interne ed esterne
- Dispositivo di misura all'estremità superiore dello strumento per una lettura facilitata
- **Base a tenuta stagna con guaina impermeabile (brevettata)**
- Bloccaggio automatico di ogni asta a fine corsa, molle interne in inox
- Fiala orizzontale e verticale per un corretto posizionamento dello strumento durante le misurazioni
- In astuccio con manico di trasporto
- Possibilità di avvitare puntalini in acciaio alle estremità per misurare nelle fessure o le diagonali

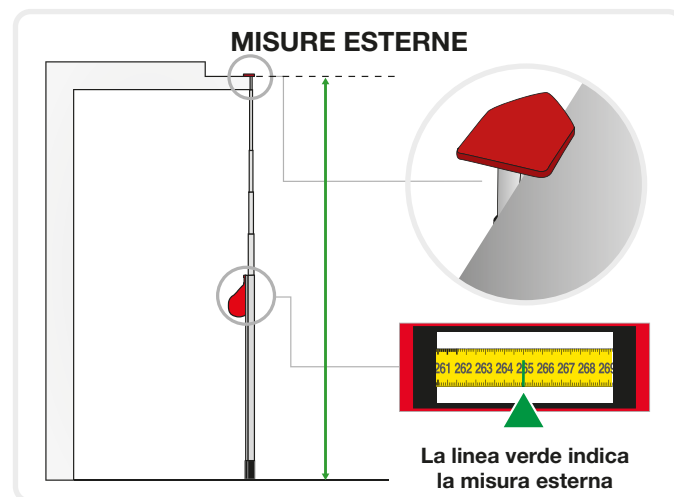
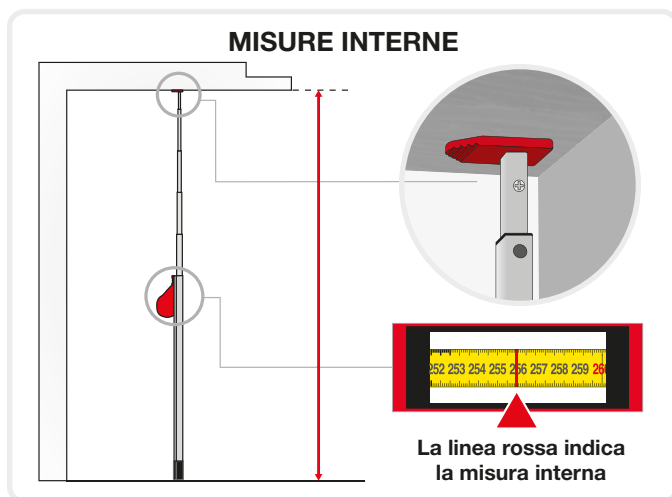

telefix
Made in Italy



TELEFIX PER SERRAMENTI METRO-TELESCOPICO



Ref.						€
49364	3 m	66 cm	mm	8001066493647	1	-

■ Per serramentisti

- Misuratore telescopico professionale a LETTURA DIRETTA SU NASTRO GRADUATO con indicazione di misure interne ed esterne
- Finestrella di misura posizionata nella parte inferiore per facilitare la lettura in caso di misurazione dei serramenti
- Base a tenuta stagna con guaina impermeabile (brevettata)
- Bloccaggio automatico di ogni asta a fine corsa
- Fiala orizzontale e verticale per un corretto posizionamento dello strumento durante le misurazioni
- Custodia di protezione in vinile con manico di trasporto

10

telefix
Made in Italy



TELEFIX PER GEODESIA



Ref.						€
49356	5 m	104 cm	mm	8001066493562	1	-

■ Modello per geodesia

- Bloccaggio a vite di ogni asta in tutte le posizioni per sostenere maggior peso
- Base a tenuta stagna con guaina impermeabile (brevettata)

ACCESSORI (+)



Adattatore per geodesia 5/8" con bloccaggio	Ref.			€
	49373	8001066493739	1	-



Adattatore in alluminio per mire	Ref.			€
	49374	8001066493746	1	-

* L'uso degli accessori fa decadere la certificazione

TELEFIX CON BRACCIO TELESCOPICO 1 m o 2 m (*)

Ref.						€
49345	5 m	103 cm	mm	8001066493456	1	-

- Struttura più rigida
- Becco di misura al carbonio, telescopico 1 - 2 m (brevettato)



ATTACCO PUNTALE



PUNTALE TELESCOPICO 1 m / 2 m

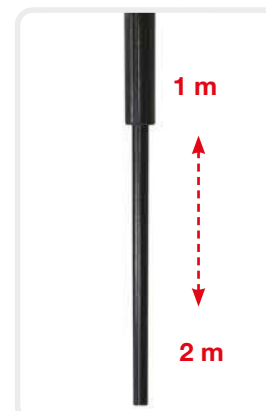

YouTube

telefix
Made in Italy

ACCESSORI PER TELEFIX (*)

PER MISURARE ANCHE NELLE SCANALATURE



Coppia puntalini 50 mm con punta arrotondata Ø 10 mm	Ref.			€
	49370	8001066493708	1	-



PER MISURARE LE DIAGONALI

Coppia puntalini 50 mm triangolari per diagonali	Ref.			€
	49371	8001066493715	1	-

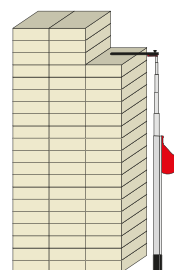

PER MISURE ESTERNE

Becco avvitabile per misure esterne lunghezza 33 cm	Ref.			€
	49377	8001066493777	1	-

* L'uso degli accessori fa decadere la certificazione



ESPOSITORI PER TELEFIX

Ref.	L x H x P		€
EXPO TELEFIX	65 x 150 x 30 cm	1	–

■ Composizione libera

telefixTM
Made in Italy

10

PALINA IN LEGNO CON PUNTALE IN METALLO FORGIATO

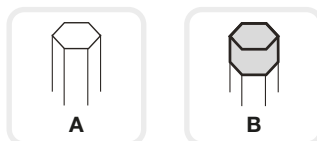

Ref.	L cm	Ø mm			€
60010	160	28	8001066600106	1	–
60011	160	28	8001066600113	1	–

- Puntale in metallo forgiato
- Corpo verniciato rosso/bianco ogni 20 cm
- Ref. **60010** senza ghiera (A)
- Ref. **60011** con ghiera metallica (B)

PALINA IN METALLO PLASTIFICATO



Ref.	L cm	Ø mm			€
60023	160	22	8001066600236	1	–
60024	160 (2 x 80)	22	8001066600243	1	–

- Corpo in metallo plastificato verniciato rosso/bianco ogni 20 cm
- Ogni palina del Ref. **60024** è composta da 2 pezzi in metallo plastificato da 80 cm avvitabili

PALINA IN FIBRORESINA



Ref.	L cm	Ø mm			€
60031	160	30	8001066600311	1	–

- Punta in acciaio temprato
- Con tappo intercambiabile

		DIMENSIONI NASTRO										TIPO DI NASTRO						CALCIOLO								
		13 mm	16 mm	19 mm	25 mm			27 mm	32 mm		33 mm	TESTURIZZATO	AUTOBLOCCANTE	DOPPIA GRADUAZIONE	NEW GRADUATION	BIANCO NUMERI GIGANTE	NYLON COATED	NUMERI VISIBILI	NO SLIP	MAGNETE FISSO	DOPPIA PRESA					
		2 metri	3 metri	3 metri	3 metri	5 metri	3 metri	5 metri	6 metri	8 metri	10 metri	5 metri	8 metri	5 metri	8 metri	5 metri	8 metri									
REVERXO				●		●		●		●															●	
pag. 94																										
METRICA ALL BLACK				●				●		●																
pag. 94																										
METRICA BLACK BULL													●	●											●	●
pag. 95																										
METRICA ACTION CHROMED			●		●		●		●																●	
pag. 96																										
FLASH			●		●		●		●																	
pag. 96																										
METRICA MAGNETE FORTE										●															●	
pag. 97																										
METRICA FLASH TOUCH			●		●		●		●		●														●	
pag. 97																										
METRICA XL 33																●	●								●	
pag. 98																										
METRICA XL 27 PLUS													●	●												
pag. 98																										
METRICA TOTAL WHITE			●		●		●		●																	
pag. 99																										
FLESSOMETRO CON VENTOSA		DIMENSIONI NASTRO 5 m x 15 mm - graduazione mm 4,5 m x 15 mm - graduazione mm/inch										TIPO DI NASTRO FIBRA DI VETRO DOPPIA GRADUAZIONE						CALCIOLO ANELLO PIU VENTOSA								
pag. 99																										
METRICA NEW GRADUATION																										
pag. 100																										
METRICA DOUBLE																										
pag. 100																										
CROMATO				●																						
pag. 101																										
CROMATO																										
pag. 101																										
METRICA NYLON COATED																										
pag. 102																										
METRICA ONE																										
pag. 102																										

	DIMENSIONI NASTRO										TIPO DI NASTRO					CALCIOLO		
	13 mm	16 mm	19 mm	25 mm	27 mm	32 mm	33 mm	TESTURIZZATO	AUTOBLOCCANTE	DOPPIA GRADUAZIONE	NEW GRADUATION	BIANCO NUMERI GIGANTE	NYLON COATED	NUMERI VISIBILI	NO SLIP	MAGNETE FISSO	DOPPIA PRESA	
METRICA RUBBER TOUCH pag. 102			●		●		●							●	●	●		
SELF LOCKING pag. 103			●		●		●											
RUBBER SELF LOCK pag. 103					●	●	●											
METRICA 3 STOP pag. 104			●		●	●	●											
3 BOTTONI pag. 104			●	●	●		●											
JUST IN pag. 105					●									●				
LOOK pag. 105			●															
TASCABILE CROMATO pag. 106	●		●		●													
TASCABILE NERO pag. 106	●		●		●													
TASCABILE GIALLO pag. 106	●		●		●		●											
TENDER COLOR pag. 107	●	●			●													
MINI WHITE pag. 107	●																	
TRANSPARENT pag. 108			●		●													
BOX 24 pag. 109			●															
PORTACHIAVI pag. 109	●																	
PORTACHIAVI pag. 109	●																	

REVERXO



Ref.	L			B mm			€
08103	3 m	16 mm	mm	70	8001066081035	12	-
08104	5 m	19 mm	mm	80	8001066081042	12	-
08105	5 m	25 mm	mm	80	8001066081059	6	-
08108	8 m	25 mm	mm	90	8001066081080	6	-

- Nastro autobloccante in ogni posizione + bottone di stop permanente/rilascio
- Graduazione su entrambe le facce:
 - fronte numerazione **orizzontale**
 - retro numerazione **verticale**
- Gancio doppia presa
- Cassa gommata rubber touch



METRICA ALL BLACK TAPE AUTOBLOCCANTE

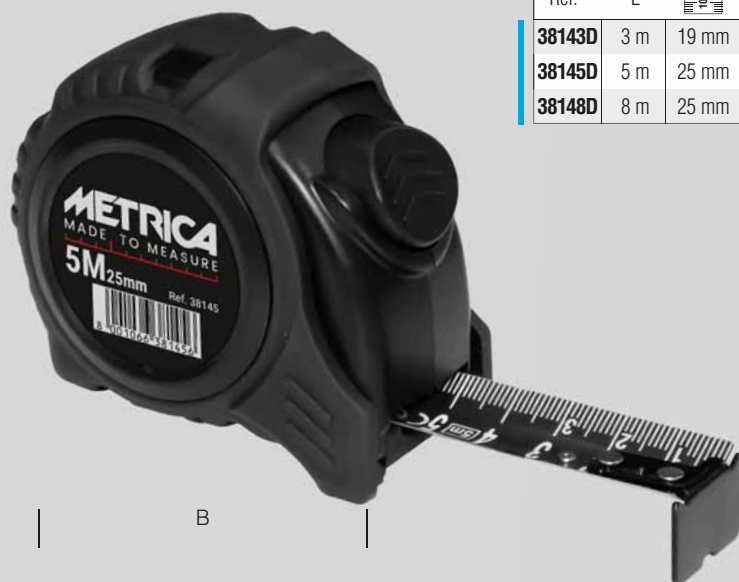

Ref.	L			B mm			€	Ref.			€
38143D	3 m	19 mm	mm	65	8001066381432	12	-	08143	8001066081431	12	-
38145D	5 m	25 mm	mm	75	8001066381456	6	-	08144	8001066081448	6	-
38148D	8 m	25 mm	mm	95	8001066381487	6	-	08148	8001066081486	6	-

- Flessometro con nastro testurizzato NERO autobloccante
- Doppia graduazione
- Cassa gommata rubber touch antiscivolo e bottone per il rilascio del nastro
- Con clip



METRICA BLACK BULL AUTOBLOCCANTE

Ref.	L			B mm			€
08075	5 m	32 mm	mm	75	8001066080755	6	-
08078	8 m	32 mm	mm	95	8001066080786	6	-



- **Nastro largo 32 mm, rivestito in nylon texturizzato**
- Graduazione su entrambe le facce:
 - fronte numerazione **orizzontale**
 - retro numerazione **verticale**
- Gancio extralarge a doppia presa
- Gancio con magnete
- Cassa gommata
- Estensione oltre 4 m



02

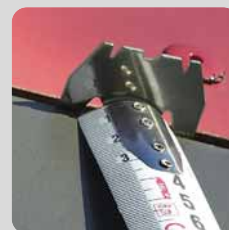

METRICA ACTION CHROMED



B

Ref.	L			B mm			€	Ref.			€
38212	3 m	16 mm	mm	73	8001066382125	6	-	08212	8001066082124	6	-
38214	5 m	19 mm	mm	83	8001066382149	6	-	08214	8001066082148	6	-
38215	5 m	25 mm	mm	83	8001066382156	6	-	08215	8001066082155	6	-
38218	8 m	25 mm	mm	95	8001066382187	6	-	08218	8001066082186	6	-

- **Nastro autobloccante** in ogni posizione
- 2 bottoni di rilascio A, C
- **Magnete fisso brevettato** a filo della partenza nastro. Elimina l'errore comune a tutti i flessometri con il magnete sul gancio
- Nastro rivestito nylon antiabrasione, antiacido e antiriflesso
- Cassa cromata rivestita in **gomma antiscivolo**
- Con clip
- **Graduazione su entrambe le facce:** fronte numerazione orizzontale, retro numerazione verticale
- **Graduazione e numerazione migliorata per una maggior visibilità**

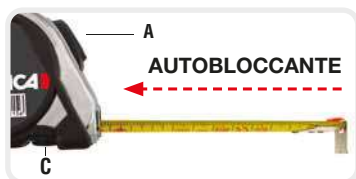

AUTOBLOCCANTE

C



YouTube



NYLON COATED



NUMERI PIÙ GRANDI



DOPPIA GRADUAZIONE



MAGNETE FISSO



B

METRICA FLASH



Ref.	L			B mm			€
08973	3 m	16 mm	mm	65	8001066089734	6	-
08974	5 m	19 mm	mm	75	8001066089741	6	-
08975	5 m	25 mm	mm	75	8001066089758	6	-
08978	8 m	25 mm	mm	95	8001066089789	6	-

- **Nastro ad effetto fluorescente**
- Graduazione su entrambe le facce:
 - fronte numerazione **orizzontale**, fondo fluorescente
 - retro numerazione **verticale**, fondo bianco
- Nastro rivestito in nylon antiabrasione, antiacido e antiriflesso
- Cassa cromata con rivestimento in gomma antiscivolo con clip
- Resistenza alla flessione verticale usando la scala a lettura verticale



DOPPIA GRADUAZIONE



NASTRO AD EFFETTO FLUORESCENTE

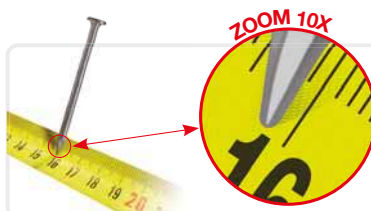

FINITURA TESTURIZZATA

- Altissima protezione
- Durata all'abrasione 10 volte superiore

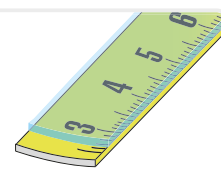

METRICA MAGNETEFORTE



Ref.	L			B mm			€	Ref.			€
38597	5 m	25 mm	mm	70	8001066385973	6	-	08597	8001066085971	6	-

- **Magnete fisso brevettato** a filo della partenza del nastro
- **Elimina l'errore** comune a tutti i flessometri con il magnete sul gancio
- Nastro rivestito in nylon antiabrasione, antiacido e antiriflesso
- Cassa cromata con rivestimento antiscivolo in vera gomma
- **Graduazione e numerazione migliorata per una maggior visibilità**
- Con clip



MAGNETE FORTE

NUMERI PIÙ GRANDI

NYLON COATED

MAGNETE FISSO: il nostro flessometro non sbaglia

MISURA ESATTA

Il magnete fissato al nastro blocca la partenza della graduazione alla superficie metallica e garantisce una lettura esatta anche tirando il nastro

MISURA ERRATA

Nei flessometri con **magnete sul gancio**, è il gancio che si fissa alla superficie metallica, e non il nastro. Così, tirando il nastro **si genera l'errore**.

METRICA FLASH TOUCH



Ref.	L			B mm			€
08963	3 m	16 mm	mm	60	8001066089635	12	-
08964	5 m	19 mm	mm	70	8001066089642	12	-
08965	5 m	25 mm	mm	70	8001066089659	6	-
08968	8 m	25 mm	mm	82	8001066089680	6	-
08970	10 m	25 mm	mm	92	8001066089703	6	-

- Cassa bimateriale rivestita in **gomma antiscivolo**
- Nastro rivestito in **nylon** antiabrasione, antiacido, antiriflesso
- Elevata **scorrevolezza del nastro**
- Numerazione chiara e visibile
- Design compatto
- Con Clip





B

METRICA XL 33



Ref.	L			B mm			€
08755	5 m	33 mm	mm	70	8001066087556	1	-
08758	8 m	33 mm	mm	80	8001066087587	1	-

- **Nastro largo 33 mm rivestito in nylon**
- **Speciale gancio mobile con gomma alettata all'interno che aumenta la presa (brevettato)**
- Lunga durata, antiabrasione, antiacido e antiriflesso
- Rigidità eccezionale: sino a 3 m in orizzontale e 4,5 m in verticale
- Numerazione gigante per una lettura facilitata
- Cassa bimateriale in acciaio inox rivestita in gomma antiscivolo
- Rientro del nastro ammortizzato
- Con clip

RESISTENZA alla FLESSIONE:

- Resistenza alla flessione **3 m** in orizzontale
- Estensione verticale **4,5 m** con nastro letto sul retro

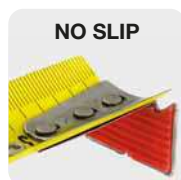
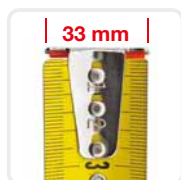

B

METRICA XL 27 - PLUS

Ref.	L			B mm			€
08765	5 m	27 mm	mm	83	8001066087655	6	-
08768	8 m	27 mm	mm	95	8001066087686	6	-

- **Nastro 27 mm**
- **Superficie testurizzata del nastro**
- **Guaina in nylon a spessore maggiorato per altissima protezione del nastro**
- **Durata all'abrasione 10 volte superiore**
- Graduazione su entrambe le facce:
 - fronte numerazione orizzontale
 - retro numerazione verticale
- Cassa bimateriale in acciaio inox rivestita in gomma antiscivolo
- Rigidità eccezionale: sino a 2,6 m in orizzontale e 4 m in verticale
- Rientro del nastro ammortizzato
- Con clip

RESISTENZA ALLA FLESSIONE:

- Resistenza alla flessione **2,6 m** in orizzontale
- Estensione verticale **4 m** con nastro letto sul retro



DOPPIA GRADUAZIONE

FINITURA TESTURIZZATA

- Altissima protezione anche sui bordi
- **Durata all'abrasione 10 volte superiore**





TOTAL WHITE



Ref.	L			B mm			€
08320	3 m	16 mm	mm	70	8001066083206	6	-
08321	5 m	19 mm	mm	75	8001066083213	6	-
08322	5 m	25 mm	mm	75	8001066083220	6	-
08323	8 m	25 mm	mm	100	8001066083237	6	-

- Superficie testurizzata del nastro
- Guaina in nylon a spessore maggiorato per altissima protezione del nastro
- Durata all'abrasione 10 volte superiore
- Cassa in ABS rivestita con guaina antiscivolo
- Altissima resistenza alla flessione verticale usando la scala a lettura verticale
- Graduazione su entrambe le facce:
 - fronte numerazione orizzontale
 - retro numerazione verticale
- Con clip

FINITURA TESTURIZZATA

- Altissima protezione anche sui bordi
- Durata all'abrasione 10 volte superiore



FLESSOMETRO CON VENTOSA

Ref.	L			B mm			€
38402	5 m	15 mm	mm	100	8001066384020	1	-
38404	4,5 m	15 mm	mm/inch	100	8001066384044	1	-

- Nastro in fibra di vetro
- Cassa in ABS rivestita con guaina antiscivolo
- Per misurare in aderenza superfici curve o piane senza graffi
- Ideale per il wrapping di automobili, barche, allestimenti di eventi, mobili con superfici delicate
- Nastro girevole sulla ventosa per misurare due lati senza spostare la ventosa (Fig. A)
- Fornito con:
 - una ventosa di ricambio
 - una ventosa con pinza per fissaggio nastro anche per superfici concave

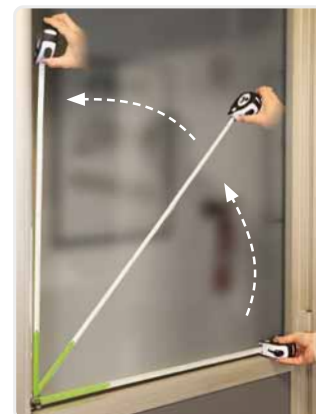

Fig. A



B



DOPIA GRADUAZIONE



YouTube

METRICA NEW GRADUATION



Ref.	L			B mm			€
08665	5 m	25 mm	mm	70	8001066086658	6	-

- **Graduazione dei mm a tratti di lunghezza variabile per una lettura facilitata - design registrato**
- Punti alternati ogni 2 mm per riconoscimento immediato
- Doppia graduazione:
 - fronte: numerazione orizzontale
 - retro: numerazione verticale
- Cassa cromata in ABS resistente agli urti
- Con clip

Non in vendita in USA e JAP



METRICA NEW GRADUATION Facilita la lettura dei mm

I numeri pari dei mm hanno un pallino di riconoscimento immediato



B



NUMERI PIÙ GRANDI



NYLON COATED



DOPIA GRADUAZIONE

METRICA DOUBLE



Ref.	L			B mm			€
38605	5 m	25 mm	mm	70	8001066386055	12	-

- **Graduazione su entrambe le facce del nastro:**
 - fronte: fondo giallo e numerazione orizzontale
 - retro: fondo bianco e numerazione verticale
- **Graduazione e numerazione migliorata per una maggior visibilità**
- Cassa cromata in ABS resistente agli urti
- Nastro rivestito in nylon antiabrasione, anticido e antiriflesso
- Con clip



- Maggiore rigidità verticale fino a **4 m**
- Sul retro numerazione verticale discendente

CROMATO



B

Ref.	L			B mm			€
38433	3 m	19 mm	mm	61	8001066384334	12	-

- **Graduazione e numerazione migliorata per una maggior visibilità**
- **Nastro largo 19 mm resistente alla flessione**
- Cassa cromata in ABS resistente agli urti
- Rientro automatico del nastro con ammortizzatore
- Con clip



CROMATO



B

Ref.	L			B mm			€	Ref.			€
38396	3 m	25 mm	mm	70	8001066383962	6	-	08396	8001066083961	6	-
38397	5 m	25 mm	mm	70	8001066383979	6	-	08397	8001066083978	6	-
38399	8 m	25 mm	mm	81	8001066383993	6	-	08399	8001066083992	6	-
38398	10 m	25 mm	mm	84	8001066383986	6	-	08398	8001066083985	6	-

- **Graduazione e numerazione migliorata per una maggior visibilità**
- **Nastro smaltato resistente alla flessione**
- Cassa cromata in ABS resistente agli urti
- Rientro automatico del nastro con ammortizzatore
- Con clip



METRICA NYLON COATED



B

Ref.	L			B mm			€	Ref.			€
38503	3 m	25 mm	mm	70	8001066385034	6	-	08503	8001066085033	6	-
38505	5 m	25 mm	mm	70	8001066385058	6	-	08505	8001066085057	6	-
38508	8 m	25 mm	mm	84	8001066385089	6	-	08508	8001066085088	6	-
38510	10 m	25 mm	mm	86	8001066385102	6	-	08510	8001066085101	6	-

- **Graduazione e numerazione migliorata per una maggior visibilità**
- **Elevata resistenza a flessione: sino a 3,5 m in verticale**
- Cassa cromata in ABS resistente agli urti
- Nastro rivestito in nylon antiabrasione, anticido e antiriflesso
- Rientro automatico del nastro con ammortizzatore
- Con clip





B

METRICA ONE



Ref.	L			B mm			€
38736	5 m	25 mm	mm	75	800106638736	1	-

- Nastro **EXTRA PRECISO**
- Nastro rivestito in nylon antiabrasione, antiacido e antiriflesso
- Cassa cromata con rivestimento in gomma antiscivolo
- Con clip



DUE VOLTE PIÙ PRECISO

TOLLERANZA **CE**

CLASSE **I** ± mm **0.60**

5 m

0.60



B

METRICA RUBBER TOUCH



Ref.	L			B mm			€
08793	3 m	16 mm	mm	60	8001066087938	12	-
08794	5 m	19 mm	mm	65	8001066087945	12	-
08795	5 m	25 mm	mm	65	8001066087952	6	-
08798	8 m	25 mm	mm	75	8001066087983	6	-
08800	10 m	25 mm	mm	85	8001066088003	6	-

- **Graduazione e numerazione migliorata per una maggior visibilità**
- **Speciale gancio mobile con gomma alettata all'interno che aumenta la presa (brevettato)**
- Nastro rivestito in nylon lunga durata, antiabrasione, antiacido e antiriflesso
- Cassa bimateriale rivestita in gomma antiscivolo
- Rientro del nastro ammortizzato
- Con clip



SELF LOCKING



Ref.	L			B mm			€	Ref.			€
38593	3 m	16 mm	mm	73	8001066385935	12	-	08593	8001066085934	12	-
38595	5 m	19 mm	mm	83	8001066385959	12	-	08595	8001066085958	12	-
38596	5 m	25 mm	mm	83	8001066385966	12	-	08596	8001066085965	6	-
38598	8 m	25 mm	mm	95	8001066385980	12	-	08598	8001066085989	6	-
38599	10 m	25 mm	mm	104	8001066385997	12	-	08599	8001066085996	6	-

- **Nastro autobloccante**
- 1 bottone di rilascio
- **Numerazione gigante**
- Nastro bianco, decimali rossi
- Cassa gommata
- Forma ergonomica
- Con clip



B

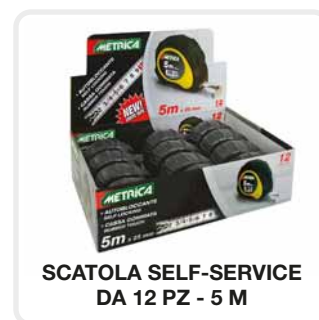

SCATOLA SELF-SERVICE
DA 12 PZ - 5 M



02

METRICA RUBBER SELF LOCK



Ref.	L			B mm			€
08403	3 m	25 mm	mm	70	8001066084036	6	-
08405	5 m	25 mm	mm	70	8001066084050	6	-
08409	8 m	25 mm	mm	80	8001066084098	6	-

- **Nastro autobloccante**
- 1 bottone di rilascio C
- **Cassa gommata rubber touch**
- Con appendibilità
- Con clip



B



C

METRICA 3 STOP



Ref.	L			B mm			€	Ref.			€
38643H	3 m	16 mm	mm	68	8001066386437	12	–	08643H	8001066086436	12	–
38645H	5 m	19 mm	mm	78	8001066386451	12	–	08645H	8001066086450	12	–
38646H	5 m	25 mm	mm	78	8001066386468	6	–	08646H	8001066086467	6	–
38647H	6 m	25 mm	mm	83	8001066386475	6	–	08647H	8001066086474	6	–
38648H	8 m	25 mm	mm	83	8001066386482	6	–	08648H	8001066086481	6	–

■ Triplice sistema di bloccaggio:

- bloccaggio permanente a leva centrale
- pulsante laterale e pulsante inferiore per frenare o bloccare istantaneamente il nastro

■ Cassa rivestita con guaina antiscivolo

■ Con clip



B



3 BOTTONI



Ref.	L			B mm			€	Ref.			€
38653	3 m	16 mm	mm	68	8001066386536	12	–	08653	8001066086535	12	–
38654	3 m	19 mm	mm	68	8001066386543	12	–	08654	8001066086542	12	–
38655	5 m	19 mm	mm	74	8001066386550	12	–	08655	8001066086559	12	–
38656	5 m	25 mm	mm	74	8001066386567	6	–	08656	8001066086566	6	–
38658	8 m	25 mm	mm	83	8001066386581	6	–	08658	8001066086580	6	–
38660	10 m	25 mm	mm	90	8001066386604	6	–	08660	8001066086603	6	–

■ Triplice sistema di bloccaggio:

- bloccaggio permanente a leva centrale
- pulsanti laterali per frenare o bloccare istantaneamente il nastro

■ Cassa rivestita con guaina antiscivolo

■ Con clip



B





B

JUST-IN

CE II

Ref.	L			B mm			€	Ref.			€
38206	5 m	19 mm	mm	70	8001066382064	6	-	08206	8001066082063	6	-

- **Finestra per lettura diretta misure interne**
- Nastro rivestito in nylon antiabrasione, antiacido e antiriflesso
- Cassa cromata
- Con clip



15 cm

LOOK

CE II

Ref.	L			B mm			€	Ref.			€
38264	3 m	16 mm	mm	60	8001066382644	6	-	08264	8001066082643	6	-



B

- **Finestra per lettura diretta misure interne**
- Cassa in bimateriale con parte in gomma antiscivolo
- Con clip



15 cm

02

TASCABILE CROMATO

CE (II)



B

Ref.	L			B mm			€	Ref.			€
38182	2 m	13 mm	mm	60	8001066381821	12	–	08182	8001066081820	12	–
38183	3 m	16 mm	mm	60	8001066381838	12	–	08183	8001066081837	12	–
38185	5 m	19 mm	mm	68	8001066381852	12	–	08185	8001066081851	12	–
38196	5 m	25 mm	mm	68	8001066381968	6	–	08196	8001066081967	6	–

- Cassa cromata
- Tascabile
- Con clip

TASCABILE NERO

CE (II)



B

Ref.	L			B mm			€	Ref.			€
38162	2 m	13 mm	mm	60	8001066381623	12	–	08162	8001066081622	12	–
38163	3 m	16 mm	mm	60	8001066381630	12	–	08163	8001066081639	12	–
38165	5 m	19 mm	mm	68	8001066381654	12	–	08165	8001066081653	12	–

- Cassa nera in ABS forma ergonomica
- Bloccaggio e rientro automatico del nastro
- Con clip

TASCABILE GIALLO

CE (II)



B

Ref.	L			B mm			€	Ref.			€
38362	2 m	13 mm	mm	60	8001066383627	12	–	08362	8001066083626	12	–
38363	3 m	16 mm	mm	60	8001066383634	12	–	08363	8001066083633	12	–
38365	5 m	19 mm	mm	68	8001066383658	12	–	08365	8001066083657	12	–
38496	5 m	25 mm	mm	68	8001066384969	6	–	08496	8001066084968	6	–
38497	8 m	25 mm	mm	80	8001066384976	6	–	08497	8001066084975	6	–

- Cassa gialla in ABS forma ergonomica
- Bloccaggio e rientro automatico del nastro
- Nastro smaltato opaco antiriflesso
- Con clip

TENDER COLOR

Ref.	L				Ref.			€
38912	2 m	13 mm	mm		08912	8001066389123	12	-
38913	3 m	13 mm	mm		08913	8001066089130	12	-
38915	5 m	19 mm	mm		08915	8001066089154	12	-
38922	2 m	13 mm	mm		08922	8001066089222	12	-
38923	3 m	13 mm	mm		08923	8001066089239	12	-
38925	5 m	19 mm	mm		08925	8001066089253	12	-
38932	2 m	13 mm	mm		08932	8001066089321	12	-
38933	3 m	13 mm	mm		08933	8001066089338	12	-
38935	5 m	19 mm	mm		08935	8001066089352	12	-
38892	2 m	13 mm	mm		08892	8001066088928	12	-
38893	3 m	13 mm	mm		08893	8001066088935	12	-
38895	5 m	19 mm	mm		08895	8001066088959	12	-



- Cassa ABS resistente agli urti
- Disponibile in tre colori luminosi oppure in nero
- Con clip



02

MINI WHITE



Ref.	L			B mm			€
38962	2 m	13 mm	mm	45	8001066389629	12	-

- Cassa bimateriale con parte in gomma antiscivolo
- Nastro antiriflesso
- Supercompatto
- Elevata scorrevolezza del nastro
- Numerazione chiara e visibile



B

TRANSPARENT

Ref.	L			B mm			€
38751	3 m	16 mm	mm	58	8001066387519	12	—
38761	3 m	16 mm	mm	58	8001066387618	12	—
38771	3 m	16 mm	mm	58	8001066387717	12	—
38754	5 m	19 mm	mm	67	8001066387540	12	—
38764	5 m	19 mm	mm	67	8001066387649	12	—
38774	5 m	19 mm	mm	67	8001066387748	12	—



- Nastro bianco
- Colori assortiti
- **Doppia graduazione (verticale + orizzontale)**
- Numerazione gigante per una lettura facilitata
- Cassa trasparente
- Con clip



B

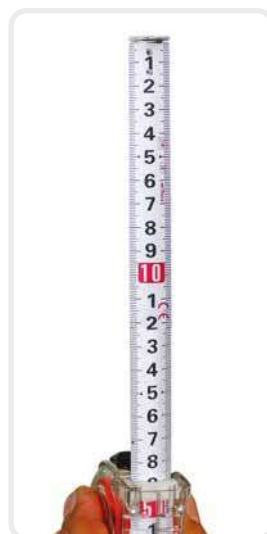

SCATOLA SELF SERVICE COLORI ASSORTITI

Ref.		Pezzi per scatola	L	€
89780	8001066897803	12	5 m	—

BOX 24



Ref.	L			B mm			€
38940	3 m	13 mm	mm	61	8001066389407	1	-

- Box con 24 flessometri in tre colori assortiti
- Tascabile senza clip



PORTACHIAVI

Ref.	L			B mm			€
38028	2 m	13 mm	mm	45	8001066380282	12	-
38029	2 m	13 mm	mm	45	8001066380299	12	-
38030	2 m	13 mm	mm	45	8001066380305	12	-

- Cassa bimateriale con parte in gomma antiscivolo
- Nastro antiriflesso
- Supercompatto
- Elevata scorrevolezza del nastro
- Numerazione chiara e visibile
- Catenella con anello a vite

PORTACHIAVI

Ref.	L			B mm			€
38031	2 m	13 mm	mm	45	8001066380312	12	-
38032	2 m	13 mm	mm	45	8001066380329	12	-
38033	2 m	13 mm	mm	45	8001066380336	12	-

- Nastro bianco
- Colori assortiti
- **Doppia graduazione (verticale + orizzontale)**
- Numerazione gigante per una lettura facilitata
- Cassa trasparente
- Catenella con anello a molla





ESPOSITORE DA BANCO



Ref.	L x H		€
EXPO FLESS	21 x 51 cm	1	-



FLASH

Ref.			€	L	
98060	8001066980604	1	-	38973 - 3m x 16 mm	12
				38974 - 5m x 19 mm	12
				38975 - 5m x 25 mm	6
				38978 - 8m x 25 mm	6

TOTAL WHITE

Ref.			€	L	
98061	8001066980611	1	-	38320 - 3m x 16 mm	24
				38321 - 5m x 19 mm	24
				38322 - 5m x 25 mm	24
				38323 - 8m x 25 mm	6























EXPO TOWER

Ref.	L x Ø		€
TOWER	160 x 32 cm	1	-

- Fornita senza flessometri
- Composizione libera

02

	NASTRO IN ACCIAIO	DIMENSIONI NASTRO								NASTRO				GANCIO		CASSA		MANOVELLA					
		10 mm	10 mm	15 mm	20 mm	25 mm	30 mm	50 mm	100 mm	ACCIAIO INOX	ACCIAIO SMALTATO	NYLON COATED	TESTURIZZATO	CON CONTRAPPESO	GANCIO CON SQUADRA	ANELLO METALLICO	BLOCCAGGIO CON MAGNETE	FORMA ERGONOMICA	IMPUGNATURA ANTISCIVOLO	TELAIO IN ALLUMINIO	MANOVELLA IN METALLO	MANOVELLA PER MANCINI	ESTRAZIONE NASTRO A MANOVELLA FERMA
SUPER ACTION STEEL								●	●	●	●				●	●	●	●	●				●
pag. 114																							
SUPER ACTION PLUS TESTURIZZATO								●		●	●		●		●	●	●	●	●	●			●
pag. 115																							
METRICA ACTION STEEL								●	●	●	●				●		Solo Ref. 39270V	Solo Ref. 39270V	●	●	●		●
pag. 116																							
NASTRO SMALTATO					●				●	●									●		●		●
pag. 117																							
NASTRO RIVESTITO NYLON					●				●	●	●								●		●		●
pag. 117																							
ACCIAIO INOX SONDA METRICA					●	●	●	●	●	●					●				●		●		
pag. 117																							
NEW RUBBER TOUCH								●	●	●						●			●		●		
pag. 118																							
TENDERCOLOR								●	●	●						●			●				
pag. 118																							
OPEN STEEL					●			●		●	●				●				●				
pag. 119																							
CASSA IN METALLO					●					●	●				●						●		
pag. 119																							

	DIMENSIONI NASTRO											NASTRO	GANCIO	CASSA	MANOVELLA							
	20 metri	30 metri	50 metri	100 metri	10 metri	15 metri	20 metri	25 metri	30 metri	50 metri	30 metri					50 metri						
NASTRO IN FIBRA DI VETRO													NASTRO A 50 FILI	CE II	GANCIO CON SQUADRA	ANELLO METALLICO	BLOCCAGGIO CON MAGNETE	IMPUGNATURA ANTISCIVOLO	TELAIO ERGONOMICO IN ALLUMINIO	QUICK RETURN	MANOVELLA IN METALLO	ESTRAZIONE NASTRO A MANOVELLA FERMA
SUPER ACTION FIBRA  pag. 120			●												●			●	●			●
METRICA QUICK RETURN  pag. 121		●	●												●			●		●		
METRICA QUICK RETURN 100 m  pag. 121				●											●			●		●		
METRICA FORTE  pag. 122										●	●		●	●	●	●	●	●		●		
METRICA OPEN  pag. 122	●																	●				
CUSTODIA IN METALLO  pag. 123					●		●	●	●	●											●	
CUSTODIA IN ABS CON IMPUGNATURA  pag. 123						●		●	●												●	
ROUND CUSTODIA IN ABS  pag. 124					●	●	●	●	●												●	
CUSTODIA IN ABS  pag. 124				●		●															●	

METRICA SUPER ACTION - STEEL

Ref.	L					€
39242V	50 m	13 mm	mm	8001066392421	1	-
39243V	100 m	13 mm	mm	8001066392438	1	-



- **Esclusiva forma ergonomica brevettata**
- **Non affatica il polso** durante l'uso e il trasporto
- **Esclusivo sistema di estrazione del nastro a manovella bloccata**
- Nastro in acciaio rivestito in nylon antiscivolo e anticorrosione
- Squadretta reclinabile di aggancio al nastro
- Speciale **impugnatura gommata** con rivestimento **antiscivolo**



SUPER ACTION PLUS TESTURIZZATO

Ref.	L					€
39244V	50 m	13 mm	mm	8001066392445	1	-



- **Esclusiva forma ergonomica brevettata**
- **Non affatica il polso** durante l'uso e il trasporto
- **Esclusivo sistema di estrazione del nastro a manovella bloccata**
- **Guaina in nylon a spessore maggiorato per protezione 10 volte superiore del nastro in acciaio**
- **Superficie del nastro testurizzata**
- **Durata all'abrasione 10 volte superiore**, anche sui bordi
- Squadretta reclinabile di aggancio al nastro
- **Gancio con anello in metallo**
- Bloccaggio gancio magnetico
- Speciale **impugnatura gommata** con rivestimento antiscivolo



YouTube

ZOOM 10X

FINITURA TESTURIZZATA

- Altissima protezione anche sui bordi
- **Durata all'abrasione 10 volte superiore**

NYLON TOTAL PROTECTION



METRICA ACTION - STEEL

Ref.	L					€
39238V	30 m	13 mm	mm	8001066392384	1	-
39270V	50 m	13 mm	mm	8001066392704	1	-



- Nastro in acciaio smaltato rivestito in nylon antiusura e anticorrosione
- **Sistema esclusivo di estrazione del nastro a manovella bloccata**
- Squadretta reclinabile di aggancio al nastro
- Cod. **39238V** gancio con anello in ABS
- Cod. **39270V** gancio con anello in metallo e bloccaggio gancio magnetico
- Speciale **impugnatura gommatata** con rivestimento antiscivolo



YouTube



ESTRAENDO IL NASTRO LA MANOVELLA NON RUOTA!



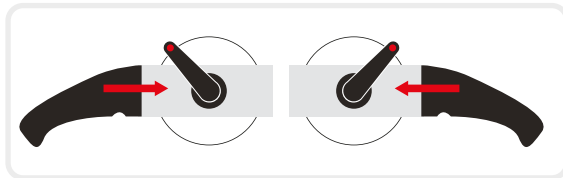

**NASTRO IN ACCIAIO
SMALTATO**



Ref.	L					€
39213V	20 m	13 mm	cm	8001066392131	1	–
39217V	50 m	13 mm	cm	8001066392179	1	–

- **Manovella montabile su entrambi i lati, adatta anche per mancini**
- Nastro bianco in acciaio smaltato
- Telaio in alluminio con impugnatura ergonomica
- Valigetta

**NASTRO IN ACCIAIO
RIVESTITO NYLON**

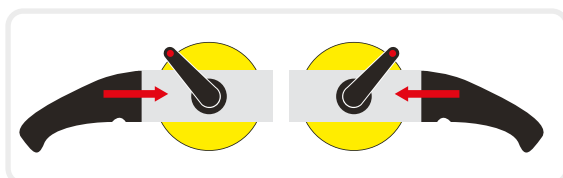

Ref.	L					€
39203V	20 m	13 mm	cm	8001066392032	1	–
39207V	50 m	13 mm	cm	8001066392070	1	–

- **Manovella montabile su entrambi i lati, adatta anche per mancini**
- Nastro giallo rivestito in nylon antiabrasione, anticorrosione e antiriflesso
- Telaio in alluminio con impugnatura ergonomica
- Valigetta

NASTRO IN ACCIAIO INOX



Ref.	L					€
39272V	15 m	13 mm	cm/inch	8001066392728	1	–
39273V	20 m	13 mm	cm/inch	8001066392735	1	–
39274V	25 m	13 mm	cm/inch	8001066392742	1	–
39275V	30 m	13 mm	cm/inch	8001066392759	1	–
39277V	50 m	13 mm	cm/inch	8001066392773	1	–

- Sonda metrica con nastro inox
- Contrappeso in ottone 700 g
- Telaio in alluminio con impugnatura ergonomica
- Valigetta

02



NEW RUBBER TOUCH



Ref.	L					€
39330	30 m	13 mm	mm	8001066393305	1	-
39350	50 m	13 mm	mm	8001066393503	1	-

- Corpo in ABS riverstito in gomma effetto **Rubber touch**
- Dimensioni e peso ridotti
- Nastro in acciaio smaltato
- Anello in metallo
- Maniglia in metallo con riavvolgimento 3X



TENDERCOLOR







Ref.	L					€
39261V	30 m	13 mm	mm	8001066392612	1	-
39262V	50 m	13 mm	mm	8001066392629	1	-

- Nastro in acciaio
- **Nastro numerazione gigante**
- Struttura in ABS con **impugnatura** ergonomica **gommata** resistente agli urti
- Nastro smaltato opaco con ammortizzatore
- **Gancio in metallo**
- Puntale in acciaio



METRICA OPEN - STEEL





Ref.	L					€
39223	20 m	13 mm	mm	8001066392230	1	-
39225	30 m	13 mm	mm	8001066392254	1	-

■ **Esclusiva custodia ergonomica in ABS**

- Nastro rivestito in nylon antiabrasione, anticorrosione e antiriflesso
- Squadretta reclinabile di aggancio del nastro



CASSA IN METALLO





Ref.	L					€
39192	20 m	13 mm	mm	8001066391929	1	-

■ **Custodia in metallo rivestita in similpelle**

- Nastro rivestito in nylon antiabrasione, anticorrosione e antiriflesso
- Manovella in metallo



METRICA SUPER ACTION FIBRA

Ref.	L					€
40029V	50 m	13 mm	cm	8001066400294	1	-



- Nastro in fibra di vetro
- **Esclusiva forma ergonomica brevettata**
- Non affatica il polso durante l'uso e il trasporto
- **Esclusivo sistema di estrazione del nastro a manovella bloccata**
- Squadretta reclinabile di aggancio al nastro
- Speciale impugnatura gommata con rivestimento antiscivolo
- Valigetta



 YouTube





METRICA QUICK-RETURN FIBERGLASS



Ref.	L					€
40023V	30 m	13 mm	cm	8001066400232	1	-
40025V	50 m	13 mm	cm	8001066400256	1	-

- Esclusivo sistema di **riavvolgimento rapido 3X** a velocità triplicata
- Sistema **ammortizzatore** del nastro a fine corsa
- Impugnatura con rivestimento gommato antiscivolo
- Custodia in ABS a struttura aperta per una maggiore pulizia del nastro



METRICA QUICK-RETURN 100 M - FIBERGLASS



Ref.	L					€
40027	100 m	13 mm	cm	8001066400270	1	-

- Esclusivo sistema di **riavvolgimento rapido 3X** a velocità triplicata
- Sistema **ammortizzatore** del nastro a fine corsa
- Impugnatura con rivestimento gommato antiscivolo
- Custodia a struttura aperta per una maggiore pulizia del nastro





METRICA FORTE



Ref.	L					€
40113	30 m	19 mm	cm	8001066401130	1	-
40115	50 m	19 mm	cm	8001066401154	1	-

- Due volte più precisa: classe II
- **Nastro 50 fili**
- **Nastro gigante larghezza 19 mm**
- Esclusivo sistema di **riavvolgimento rapido 3X** a velocità triplicata
- Sistema ammortizzatore del nastro a fine corsa
- Fianco laterale in gomma
- Impugnatura con gomma alettata antiscivolo
- Bloccaggio del gancio magnetico
- Gancio metallico

DUE VOLTE PIÙ PRECISO

TOLLERANZA CE	
CLASSE II	50 m
± mm	10.30

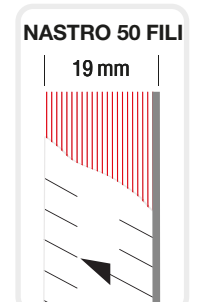

METRICA OPEN FIBERGLASS



Ref.	L					€
40223	20 m	13 mm	cm	8001066402236	1	-

- Nastro in fibra di vetro
- Esclusiva **forma ergonomica** per una presa facilitata
- Custodia in ABS resistente agli urti
- Custodia a struttura aperta per una maggiore pulizia del nastro

CUSTODIA IN METALLO



Ref. 40033



Ref. 40143

Ref.	L						€
40031	10 m	16 mm	cm	●	8001066400317	5	–
40033	20 m	16 mm	cm	●	8001066400331	5	–
40143	20 m	16 mm	cm	●	8001066401437	5	–
40034	25 m	16 mm	cm	●	8001066400348	1	–
40035	30 m	16 mm	cm	●	8001066400355	1	–
40037	50 m	16 mm	cm	●	8001066400379	1	–

- Nastro in fibra di vetro, **larghezza 16 mm**
- **Custodia in metallo rivestita in similpelle**
- Resistente agli urti
- Manovella in metallo

CUSTODIA IN ABS CON IMPUGNATURA



Ref.	L					€
40053	20 m	16 mm	cm	8001066400539	1	–
40055	30 m	16 mm	cm	8001066400553	1	–
40057	50 m	16 mm	cm	8001066400577	1	–

- Nastro in fibra di vetro, **larghezza 16 mm**
- Custodia in ABS resistente agli urti con impugnatura
- Manovella in metallo
- Custodia a struttura aperta per una migliore pulizia del nastro



ROUND CUSTODIA IN ABS



Ref.	L					€
40011	10 m	16 mm	cm	8001066400119	5	-
40012	15 m	16 mm	cm	8001066400126	5	-
40013	20 m	16 mm	cm	8001066400133	5	-
40014	25 m	16 mm	cm	8001066400140	1	-
40015	30 m	16 mm	cm	8001066400157	1	-

- Nastro in fibra di vetro, **larghezza 16 mm**
- Custodia in ABS con guarnizioni in metallo resistente agli urti
- Manovella in metallo



CUSTODIA IN ABS



Ref.	L					€
40016	10 m	16 mm	cm	8001066400164	5	-
40017	20 m	16 mm	cm	8001066400171	1	-

- Nastro in fibra di vetro, **larghezza 16 mm**
- Custodia in ABS resistente agli urti
- Manovella in metallo



TOLLERANZE

Direttiva 2014/32/UE (MID)











Se l'inizio o la fine della misura non è una linea della graduazione ma una superficie le tolleranze sono aumentate (per ciascuna superficie) di:









CLASSE I: ± 0,1 mm II: ± 0,2 mm III: ± 0,3 mm



CLASSE		TOLLERANZA									
		0,5 m	1 m	2 m	3 m	5 m	10 m	20 m	30 m	50 m	100 m
I	± mm	0.15	0.20	0.30	0.40	0.60	1.10	2.10	3.10	5.10	10.10
II	± mm	0.40	0.50	0.70	0.90	1.30	2.30	4.30	6.30	10.30	20.30
III	± mm	0.80	1.00	1.40	1.80	2.60	4.60	8.60	12.60	20.60	40.60







FIBRA DI VETRO

SPESSORE 3,4 mm
NON CONDUTTORE
LAVABILE
ANTIGRAFFIO

	LUNGHEZZA					GRADUAZIONE			MOLLE			ALTRE CARATTERISTICHE					
	5 ASTE	6 ASTE	10 ASTE	10 ASTE	15 ASTE	MILLIMETRI	DECIMALI ROSSI	LETTURA FACILITATA	SCATTO A 90°	GRADUATA SULLA 1ª ASTA	IN ACCIAIO	IN OTTONE	TASCABILE	1ª ASTA DOPPIA NUMERAZIONE	MAGNETICO	ASTA ESTENSIBILE	TESTATA CON GANCIO
DECIMALI ROSSI  Ref. 18012 Ref. 08012 pag. 128				○		●	●		●								
2 METRI 1 METRO  Ref. 18010 Ref. 08010 Ref. 18020 Ref. 08020 Ref. 18030 Ref. 08030 Ref. 19010 Ref. 09010 pag. 128	○			○	●	●			●	●							
NEW GRADUATION  Ref. 18019 pag. 129				○	●	●	●	●		●							
JUST  Ref. 18004 Ref. 08004 pag. 130				○	●	●		●		●				●			●
ASTE CALAMITATE  Ref. 18005 Ref. 08005 pag. 130				○	●	●		●		●				●			
DA FALEGNAME  Ref. 18012 pag. 131				○	●	●		●		●				●			
3 METRI  Ref. 18070 Ref. 18080 pag. 131					○	●		●	●	●							
1 METRO DECIMALI ROSSI  Ref. 19043 Ref. 09043 pag. 132			○			●	●		●	●			●				
1 METRO  Ref. 19040 Ref. 09040 Ref. 19050 Ref. 09050 Ref. 19060 Ref. 09060 pag. 132			○	●		●	●		●	●			●				
1 METRO ASTINA ESTENSIBILE  Ref. 20136 pag. 132			●			●			●	●			●			●	

		LUNGHEZZA					GRADUAZIONE			MOLLE			ALTRE CARATTERISTICHE						
		1 metro		2 metri		3 metri	MILLIMETRI	DECIMALI ROSSI	LETTURA FACILITATA	SCATTO A 90°	GRADUATA SULLA 1ª ASTA	IN ACCIAIO	IN OTTONE	PERNI INVISIBILI	TASCABILE	ALTA FLESSIBILITÀ	ALTA RIGIDITÀ	TESTATE COLORATE	TESTATE IN METALLO
		5 ASTE	6 ASTE	10 ASTE	10 ASTE	15 ASTE													
LEGNO SPESSORE 3 mm																			
BOSSO SEMIGIGANTE 	Ref. 23080 Ref. 03080 Ref. 23093 Ref. 03093 Ref. 23090 Ref. 03090			●	○	●	●		●		●					●		●	●
 pag. 133																			
DECIMALI ROSSI	Ref. 23160 Ref. 03160 Ref. 23130 Ref. 03130 Ref. 23140 Ref. 03140 Ref. 23150 Ref. 03150			●	○	●	●		●		●	●				●		●	●
 pag. 134																			
PERNI INVISIBILI	Ref. 23162			●		●	●				●	●	●			●		●	●
 pag. 135																			
3 METRI PERNI INVISIBILI	Ref. 23169 Ref. 03169				●	●	●				●	●	●			●		●	●
 pag. 135																			
BETULLA SPESSORE 2,4 mm	Ref. 23300			●		●	●				●	●	●		●			●	●
 pag. 136																			
BETULLA SEMIGIGANTE	Ref. 23085H			●		●	●				●		●			●		●	●
 pag. 136																			
MOLLE GRADUATE SP. 2,8 mm	Ref. 23152 Ref. 23119 Ref. 23110 Ref. 23120 Ref. 23128 Ref. 23126 Ref. 23127			●	○	●	●			●	●	●						●	●
 pag. 137																			
1 METRO	Ref. 22040 Ref. 02040		●			●	●							●			●	●	●
 pag. 137																			

		LUNGHEZZA					GRADUAZIONE			MOLLE			ALTRE CARATTERISTICHE				
		5 ASTE	1 metro		2 metri		MILLIMETRI	OSSIDATA INDELEBILE	LETTURA FACILITATA	SCATTO A 90°	GRADUATA SULLA 1ª ASTA	IN ACCIAIO	IN OTTONE				
			6 ASTE	10 ASTE	10 ASTE	15 ASTE											
DURALLUMINIO GRADUAZIONE INDELEBILE  Ref. 20208 Ref. 21236 pag. 139		<input checked="" type="checkbox"/>			<input checked="" type="checkbox"/>	<input checked="" type="checkbox"/>	<input checked="" type="checkbox"/>					<input checked="" type="checkbox"/>					
		<input checked="" type="checkbox"/>															
DURALLUMINIO GRADUAZIONE INDELEBILE  Ref. 20209 Ref. 21235 pag. 139		<input type="checkbox"/>			<input type="checkbox"/>	<input checked="" type="checkbox"/>	<input checked="" type="checkbox"/>					<input checked="" type="checkbox"/>					
		<input type="checkbox"/>															

		LUNGHEZZA					GRADUAZIONE			MOLLE			ALTRE CARATTERISTICHE					
		5 ASTE	1 metro		2 metri		MILLIMETRI	OSSIDATA INDELEBILE	LETTURA FACILITATA	SCATTO A 90°	GRADUATA SULLA 1ª ASTA	IN ACCIAIO	IN OTTONE	TASCABILE				
			6 ASTE	10 ASTE	10 ASTE	15 ASTE												
DURALLUMINIO GRADUAZIONE INDELEBILE  Ref. 20106 Ref. 20108 Ref. 21036 pag. 138		<input checked="" type="checkbox"/>			<input checked="" type="checkbox"/>	<input checked="" type="checkbox"/>	<input checked="" type="checkbox"/>					<input checked="" type="checkbox"/>						
		<input checked="" type="checkbox"/>																
		<input type="checkbox"/>																
DURALLUMINIO GRADUAZIONE INDELEBILE  Ref. 20107 Ref. 20109 Ref. 21035 pag. 138		<input type="checkbox"/>			<input type="checkbox"/>	<input checked="" type="checkbox"/>	<input checked="" type="checkbox"/>					<input checked="" type="checkbox"/>						
		<input type="checkbox"/>																
		<input type="checkbox"/>																
DURALLUMINIO  Ref. 20070 Ref. 20110 Ref. 21030 pag. 138		<input type="checkbox"/>			<input type="checkbox"/>	<input checked="" type="checkbox"/>	<input checked="" type="checkbox"/>					<input checked="" type="checkbox"/>						
		<input type="checkbox"/>																
		<input type="checkbox"/>																
1 METRO ACCIAIO INOX  Ref. 15030 pag. 138					<input type="checkbox"/>	<input checked="" type="checkbox"/>							<input checked="" type="checkbox"/>					
2 METRI ACCIAIO INOX  Ref. 16010 pag. 138					<input type="checkbox"/>	<input checked="" type="checkbox"/>												
DURALLUMINIO NEW GRADUATION  Ref. 20109_NG Ref. 21035_NG pag. 139		<input type="checkbox"/>			<input type="checkbox"/>	<input checked="" type="checkbox"/>	<input checked="" type="checkbox"/>	<input checked="" type="checkbox"/>				<input checked="" type="checkbox"/>						
		<input type="checkbox"/>																



02



2 METRI - FIBRA DI VETRO



Ref.	L						€	Ref.			€
18012	2 m	10	mm	○	8001066180127	12	-	08012	8001066080120	10	-

- Graduazione incisa con decimali rossi
- Snodi con doppia molla antiusura e scatto a 90°
- Non conduttore, lavabile, non graffia la superficie

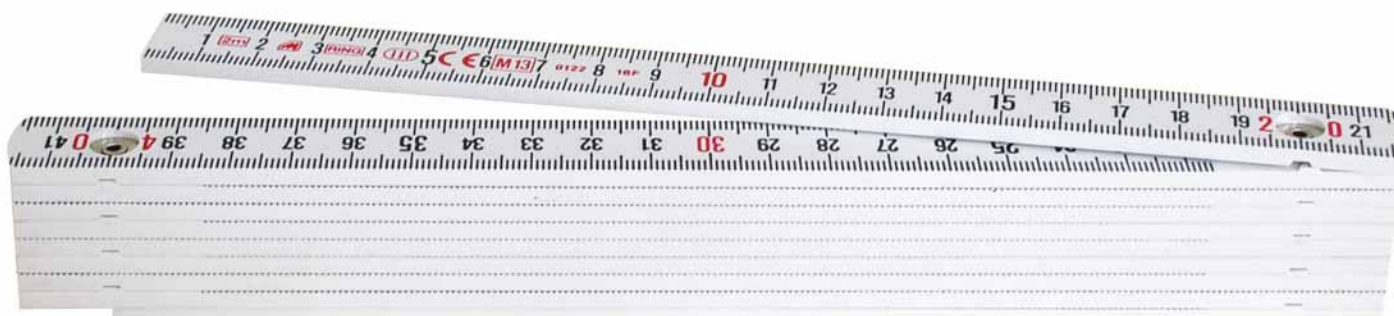

2 METRI - 1 METRO - FIBRA DI VETRO



Ref.	L						€	Ref.			€
18010	2 m	10	mm	○	8001066180103	12	-	08010	8001066080106	10	-
18020	2 m	10	mm	●	8001066180202	12	-	08020	8001066080205	10	-
18030	2 m	10	mm	●	8001066180301	12	-	08030	8001066080304	10	-
19010	1 m	5	mm	○	8001066190102	12	-	09010	8001066090105	10	-

- Graduazione incisa
- Snodi con doppia molla antiusura e scatto a 90°
- Non conduttore, lavabile, non graffia la superficie

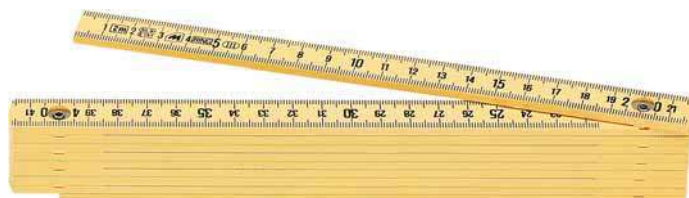

Ref. 18020

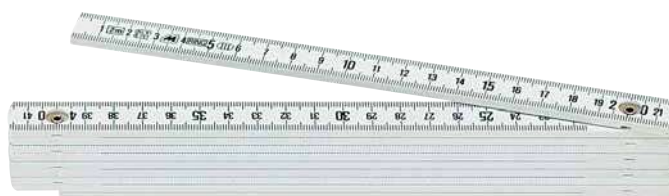

Ref. 18010

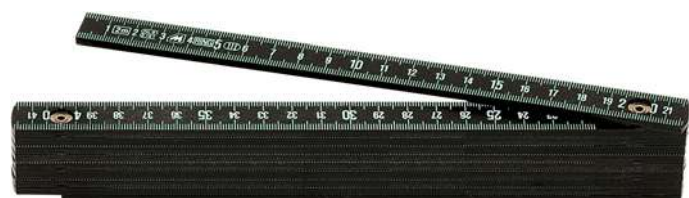

Ref. 18030



Ref. 19010

2 METRI - FIBRA DI VETRO - NEW GRADUATION

Ref.	L					€
18019	2 m	10	mm	8001066180196	12	-



- Graduazione dei mm a tratti di lunghezza variabile per una **lettura facilitata** - design registrato
- Punti alternati ogni 2 mm per riconoscimento immediato
- Graduazione incisa
- Snodi con doppia molla antiusura e scatto a 90°
- Non conduttore, lavabile, non graffia la superficie



02



METRICA NEW GRADUATION

Facilita la lettura dei mm
I numeri pari dei mm hanno un pallino di riconoscimento immediato

YouTube

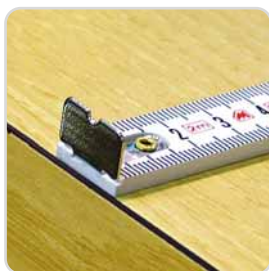

JUST - IL METRO CON IL GANCIO



Ref.	L						€	Ref.			€
18004	2 m	10	mm	○	8001066180042	12	-	08004	8001066080045	10	-

- Speciale gancio di presa brevettato per misure interne ed esterne
- La numerazione parte su entrambe le facce della stecca con il gancio
- Decimali rossi
- Prima stecca sempre aderente al piano da misurare
- Ideale per misurare da soli o in posizioni difficilmente accessibili

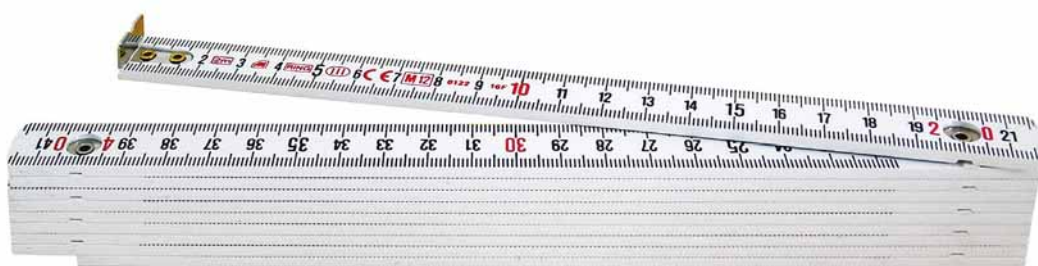
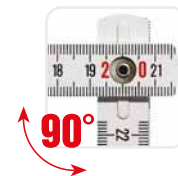

2 METRI - FIBRA DI VETRO ASTE CALAMITATE



Ref.	L						€	Ref.			€
18005	2 m	10	mm	○	8001066180059	12	-	08005	8001066080052	10	-

- Stecche calamitate per misure aderenti a superfici metalliche a mani libere
- Graduazione incisa con decimali rossi
- Snodi con doppia molla antiusura e scatto a 90°
- Non conduttore, lavabile, non graffia la superficie



LAVORO A MANI
LIBERE!

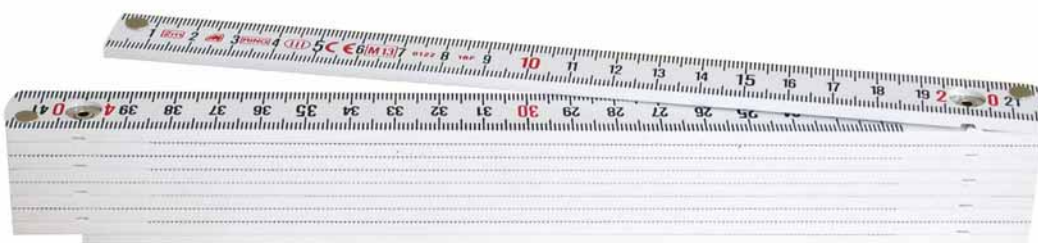
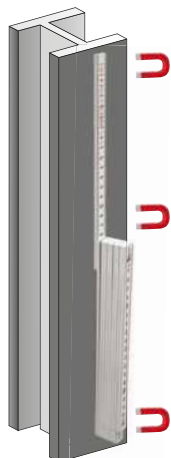

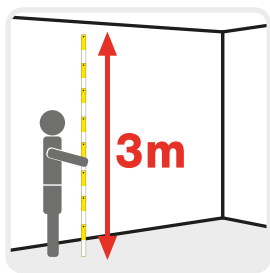

3 METRI - FIBRA DI VETRO



Ref.	L					€	
18070	3 m	15	mm		8001066180707	10	-
18080	3 m	15	mm		8001066180806	10	-

- **Lunghezza 3 metri**
- Graduazione incisa
- Snodi con doppia molla antiusura e scatto a 90°
- Non conduttore, lavabile, non graffia la superficie



METRO DA
FALEGNAME

- appoggio completo sul piano
- graduazione sempre aderente alla superficie da misurare



ASTA
TRADIZIONALE

2 METRI - FIBRA DI VETRO DA FALEGNAME



Ref.	L					€	
18006	2 m	10	mm		8001066180066	12	-

- **Lunghezza 2 metri**
- **La numerazione inizia dalla prima asta su entrambe le facce**
- Decimali rossi
- Snodi con doppia molla antiusura e scatto a 90°
- Non conduttore, lavabile, non graffia la superficie
- Uso agevolato sul piano

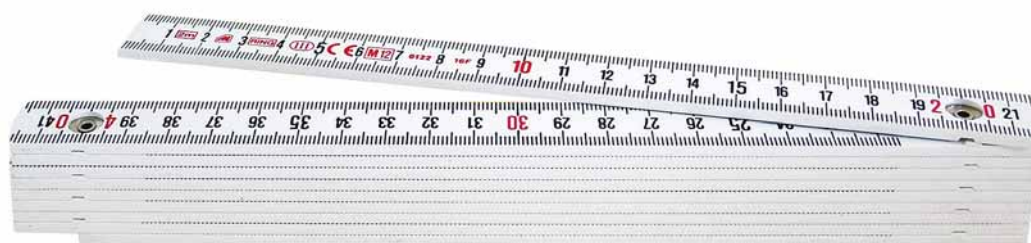

**LA NUMERAZIONE
INIZIA DALLA PRIMA
ASTA SU ENTRAMBE
LE FACCE**









FRONTE



RETRO



1 METRO - FIBRA DI VETRO











Ref.	L						€	Ref.			€
19043	1 m	10	mm		8001066190430	12	-	09043	8001066090433	10	-



- Tascabile
- **Graduazione incisa con decimali rossi**
- Snodi con doppia molla antiusura e scatto a 90°
- Non conduttore, lavabile, non graffia la superficie



1 METRO - FIBRA DI VETRO - TASCABILE

Ref.	L						€	Ref.			€
19040	1 m	10	mm		8001066190409	12	-	09040	8001066090402	10	-
19050	1 m	10	mm		8001066190508	12	-	09050	8001066090501	10	-
19060	1 m	10	mm		8001066190607	12	-	09060	8001066090600	10	-



- Tascabile
- Graduazione incisa
- Snodi con doppia molla antiusura e scatto a 90°
- Non conduttore, lavabile, non graffia la superficie

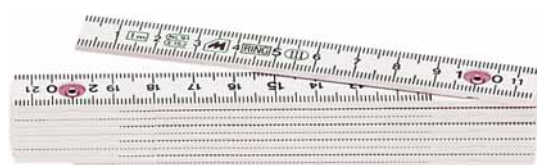

Ref. 19040

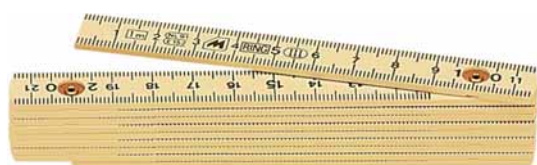

Ref. 19050



Ref. 19060

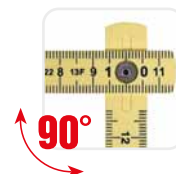

1 METRO - FIBRA DI VETRO CON ASTINA ESTENSIBILE

Ref.	L						€
20136	1 m	10	mm		8001066201365	10	-



- Astina estensibile con bloccaggio per comparazioni
- Graduazione incisa solo su un lato
- Snodi con doppia molla antiusura e scatto a 90°
- Lunghezza astina 100 mm

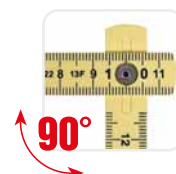
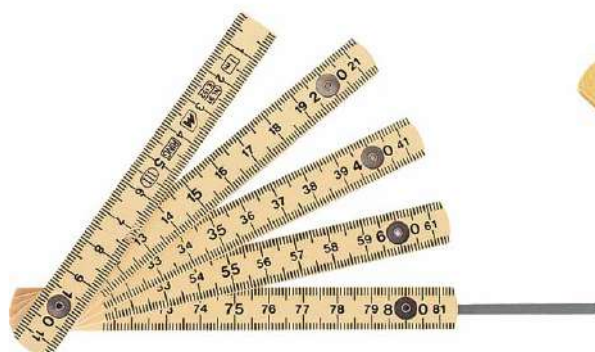

2 METRI - TIPO BOSSO SEMIGIGANTE SPESSORE 3 mm - MOLLE INTERNE



Ref.	L					€	Ref.			€
23080	2 m	10	mm		8001066230808	12	03080	8001066030804	10	-
23093	2 m	10	mm		8001066230938	12	03093	8001066030934	10	-
23090	2 m	10	mm		8001066230907	12	03090	8001066030903	10	-

- Tipo bosso semigigante
- Molle interne in acciaio temprato con scatto a 90°
- Doppia graduazione
- Spessore 3 mm
- Rigido fino a 2 m in orizzontale e verticale

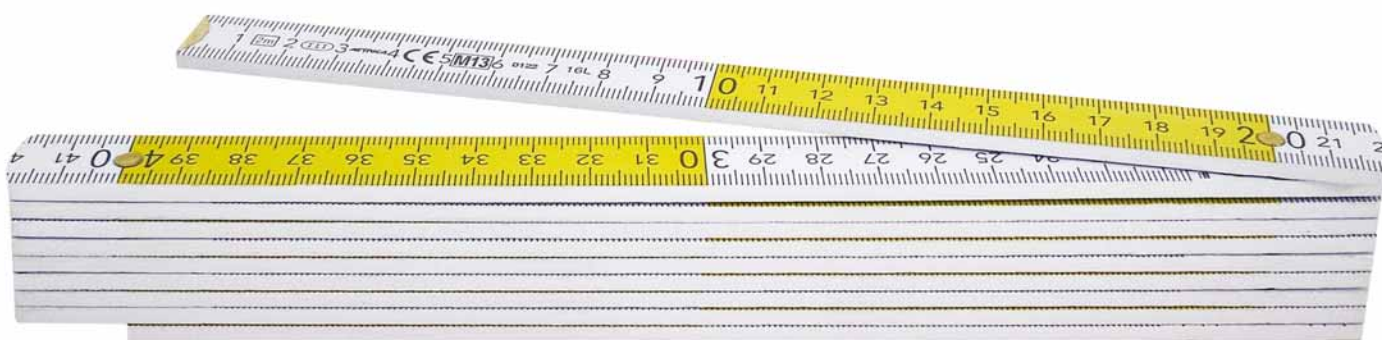

Ref. 23080

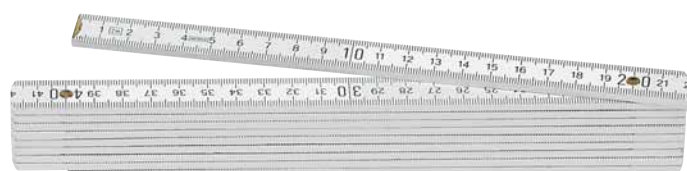

Ref. 23093

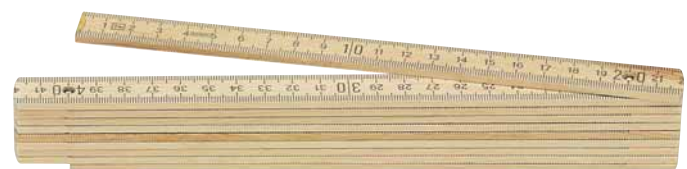

Ref. 23090



02



SCATOLA SELF SERVICE DA 50 PEZZI

Ref.		Pezzi per Ref.	L	€
89090	8001066890903	50 x 23080	2 m	-
89091	8001066890910	50 x 23090	2 m	-

2 METRI - IN LEGNO - SPESSORE 3 mm

Ref.	L						€	Ref.			€
23160	2 m	10	mm		8001066231607	10	-	03160	8001066031603	10	-
23130	2 m	10	mm		8001066231300	10	-	03130	8001066031306	10	-
23140	2 m	10	mm		8001066231409	10	-	03140	8001066031405	10	-
23150	2 m	10	mm		8001066231504	10	-	03150	8001066031504	10	-



Modello professionale alta resistenza

- Laccatura multipla
- Doppia graduazione con decimali rossi
- Testate rosse
- Molle a scatto in acciaio ottonato
- Spessore 3 mm
- Rigido fino a 2 m in orizzontale e verticale

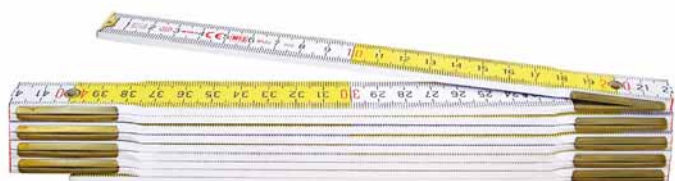
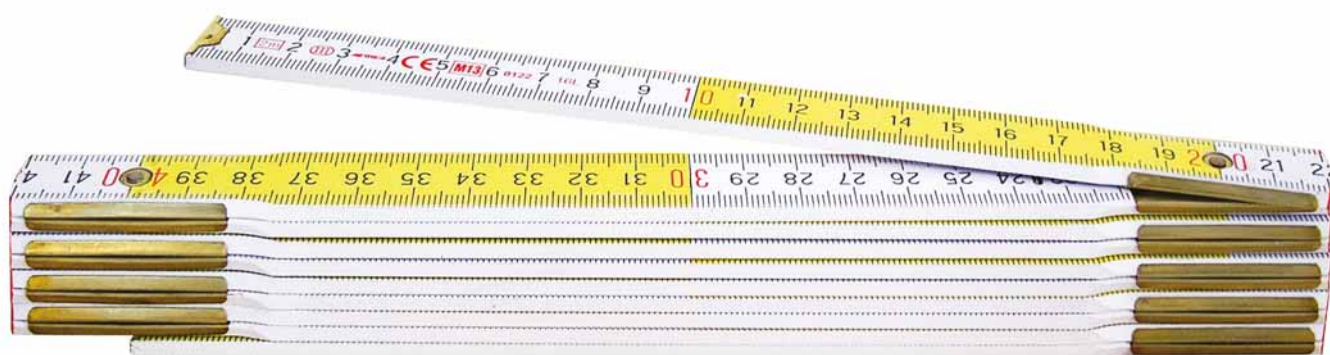

Ref. 23160



Ref. 23130

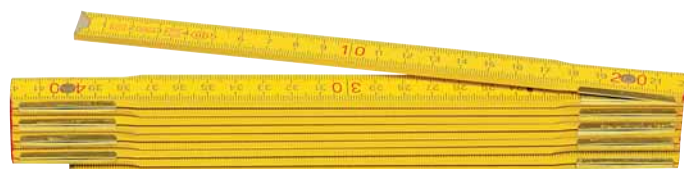

Ref. 23140



Ref. 23150



SCATOLA SELF SERVICE DA 50 PEZZI

Ref.		Pezzi per Ref.	L	€
89086	8001066890866	50 x 23160	2 m	-
89092	8001066890927	50 x 23130	2 m	-



2 METRI - METRO IN LEGNO

CE III

Ref.	L						€
23162	2 m	10	mm		8001066231621	10	-

- **Modello professionale**
- **Perni invisibili**
- Laccato bianco/giallo
- Molle ottonate
- Doppia graduazione con decimali rossi
- Spessore 3 mm
- Rigido fino a 2 m in orizzontale e verticale

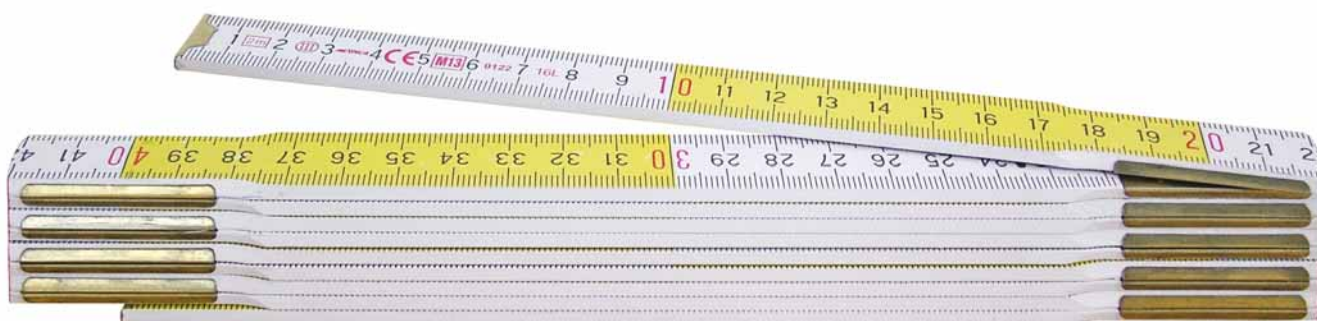

3 METRI - SEMIGIGANTE SPESSORE 3 mm - MOLLE INTERNE

CE III

Ref.	L						€	Ref.			€
23169	3 m	15	mm		8001066231690	10	-	03169	8001066031696	10	-

- Modello professionale
- Laccato bianco / giallo
- **Perni invisibili, molle ottonate**
- Doppia graduazione con decimali rossi
- Spessore 3 mm
- **Rigido fino a 3 m in verticale**

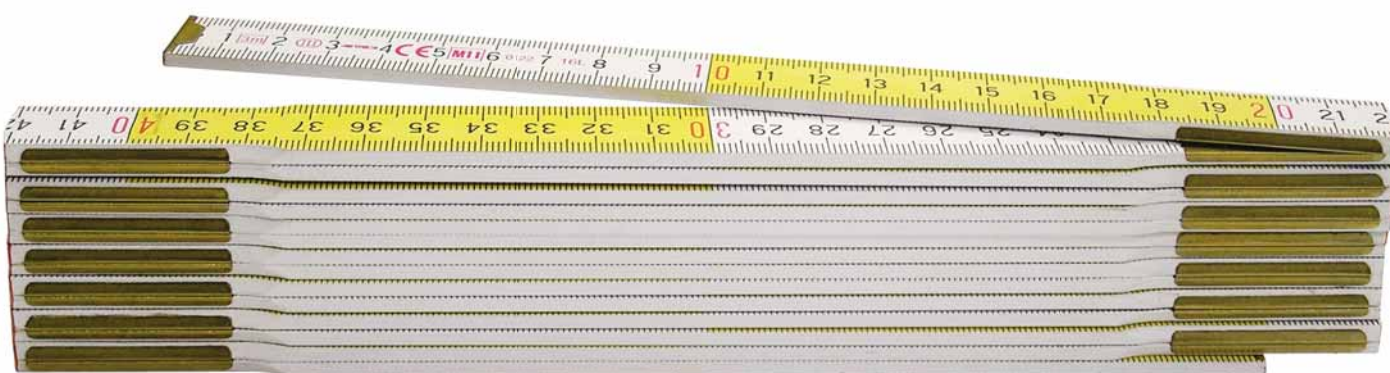
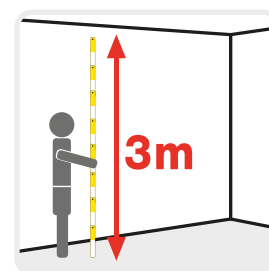

02



2 METRI - BETULLA - SPESSORE 2,4 mm



Ref.	L						€
23300	2 m	10	mm		8001066233007	10	-

- Betulla flessibile
- Perni invisibili
- Molla trattata resistente all'usura
- Spessore 2,4 mm
- Rigido in costa sulla lunghezza

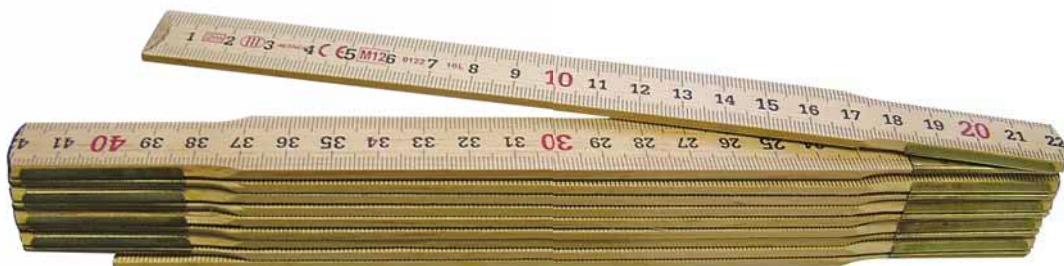

2 METRI - BETULLA SEMIGIGANTE



Ref.	L						€
23085H	2 m	10	mm		8001066230853	10	-

- Modello professionale in betulla
- Perni invisibili
- Laccato bianco/giallo
- Molle trattate resistenti all'usura
- Doppia graduazione con decimali neri
- Spessore 3 mm
- Rigido fino a 2 m in orizzontale e verticale



DECIMALI ROSSI



DECIMALI NERI



2 METRI - IN LEGNO



Ref.	L	Molle	Graduazione	DECIMALI		Barcode	Pacchetti	€
				ROSSI	NERI			
23152	2 m	10	mm	●	○	8001066231522	10	-
23119	2 m	10	mm	○	○	8001066231195	10	-
23110	2 m	10	mm	●	○	8001066231102	10	-
23120	2 m	10	mm	●	○	8001066231201	10	-
23128	2 m	10	mm	○	○	8001066231287	10	-
23126	2 m	10	mm	●	○	8001066231263	10	-
23127	2 m	10	mm	●	○	8001066231270	10	-

- Molle antiruggine
- Doppia graduazione con decimali rossi o neri
- Spessore 2,8 mm



Ref. 23152 - Ref. 23127

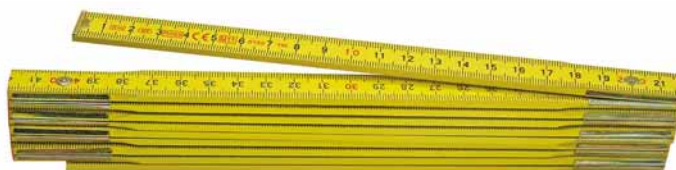

Ref. 23120



Ref. 23119 - Ref. 23128



Ref. 23110 - Ref. 23126

1 METRO - IN LEGNO - TASCABILE



Ref.	L	Molle	Graduazione	Barcode	Pacchetti	€	Ref.	Barcode	Pacchetti	€	
											22040

- Senza molle
- Doppia graduazione
- Decimali rossi
- Testate rosse



1 METRO - 2 METRI DURALLUMINIO

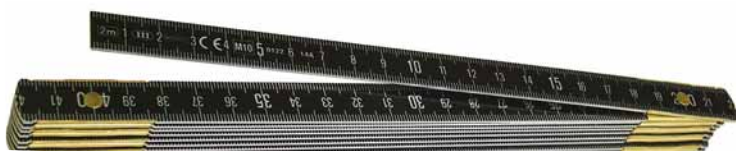

Ref. 21036



Ref. 20108

Ref.	L					€
20106	1 m	6	mm	8001066201068	12	-
20108	1 m	5	mm	8001066201082	12	-
21036	2 m	10	mm	8001066210367	12	-

- In duralluminio nero
- **Graduazione ossidata indelebile**
- Molle trattate in ottone

1 METRO - 2 METRI DURALLUMINIO

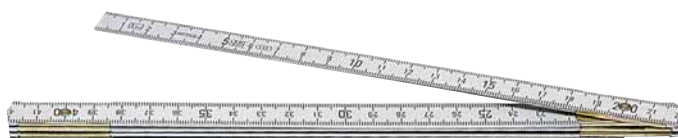

Ref. 20109 - Ref. 20110



Ref. 21035 - Ref. 21030

Ref.	L					€
20107	1 m	6	mm	8001066201075	12	-
20109	1 m	5	mm	8001066201099	12	-
21035	2 m	10	mm	8001066210350	12	-

- **Graduazione ossidata indelebile**
- In duralluminio
- Molle trattate in ottone

Ref.	L					€
20070	1 m	6	mm	8001066200702	12	-
20110	1 m	5	mm	8001066201105	12	-
21030	2 m	10	mm	8001066210305	12	-

- In duralluminio
- Molle trattate in ottone



Ref. 15030



Ref. 16010

1 METRO - 2 METRI ACCIAIO INOX



Ref.	L		A x B mm				€
15030	1 m	10	12 x 0,5	mm	8001066150304	6	-
16010	2 m	10	14 x 0,6	mm	8001066160105	6	-

- In acciaio inox
- Graduazione incisa e annerita

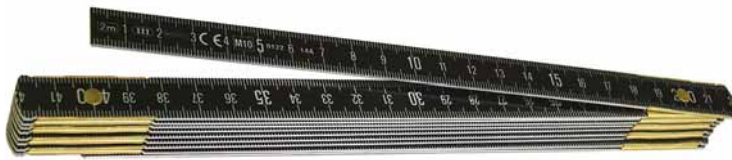

Ref. 21236



Ref. 20208

1 METRO - 2 METRI DURALLUMINIO



Ref.	L					€
20208	1 m	5	mm	8001066202089	12	-
21236	2 m	10	mm	8001066212361	12	-

- **Classe II: due volte più preciso**
- In duralluminio nero
- **Graduazione ossidata indelebile**
- Molle trattate in ottone



Ref. 20209



Ref. 21235

1 METRO - 2 METRI DURALLUMINIO



Ref.	L					€
20209	1 m	5	mm	8001066202096	12	-
21235	2 m	10	mm	8001066212354	12	-

- **Classe II: due volte più preciso**
- **Graduazione ossidata indelebile**
- In duralluminio
- Molle trattate in ottone



Ref. 20109_NG



Ref. 21035_NG

1 METRO - 2 METRI NEW GRADUATION



Ref.	L					€
20109_NG	1 m	5	mm	8001066201099	12	-
21035_NG	2 m	10	mm	8001066210350	12	-

- **Graduazione dei mm a tratti di lunghezza variabile per una lettura facilitata - design registrato**
- Punti alternati ogni 2 mm per riconoscimento immediato
- **Graduazione ossidata indelebile**
- In duralluminio
- Molle trattate in ottone



METRO AD ASTA IN FAGGIO

Ref.	L	A x B mm	mm	mm	mm	mm	mm	mm	mm	mm	€
22071	1 m	25 x 20	cm	mm	mm	mm	mm	mm	mm	mm	-



- Metro ad asta in faggio
- Graduazione in cm
- Testate in metallo



METRO PER SARTO

Ref.	L	mm	mm	mm	mm	mm	mm	mm	mm	mm	€
22091	1,5 m	20 mm	cm	mm	mm	mm	mm	mm	mm	mm	-



- Nastro in fibra di vetro plastificato
- Doppia graduazione su entrambi i lati
- Puntale rigido

METRO PER SARTO

Ref.	L	mm	mm	mm	mm	mm	mm	mm	mm	mm	€
22110	1,5 m	10 mm	mm	mm	mm	mm	mm	mm	mm	mm	-



- Cassa in ABS resistente agli urti
- Nastro in fibra di vetro
- Graduazione su entrambi i lati
- Con autobloccaggio e rientro rapido a pulsante

FINGERSAFE

Ref.	Barcode	Box	€
69997	8001066699971	12	-

- **Battichiodo magnetico salvadito per chiodi piccoli e grandi**
- Consente di piantare il chiodo sempre perpendicolare alla parete in totale sicurezza per le dita
- Doppio magnete per trattenere il chiodo in qualunque posizione
- Fornito in blister con 20 chiodini



MAGNETICO



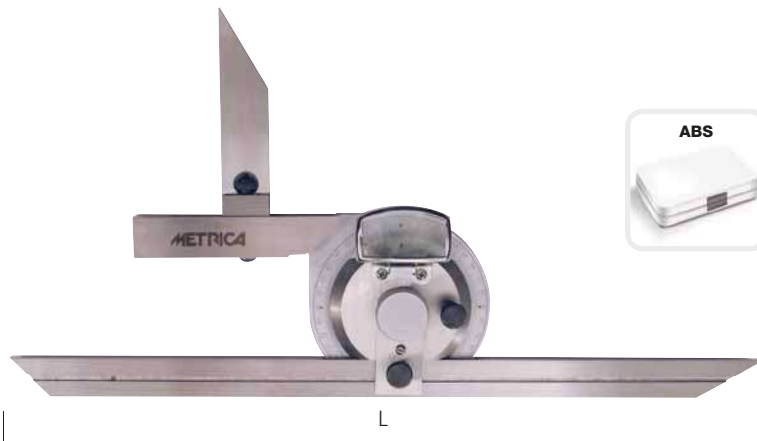

GONIOMETRO UNIVERSALE A NONIO

Ref.	L mm	Barcode	Box	€
36030	200 - 300	8001066360307	1	-

- Acciaio inox
- Scala cromata
- Lettura diretta 5' con lente di ingrandimento
- Squadretta per piccoli angoli
- Fornita con 2 regoli scorrevoli 200 e 300 mm
- Astuccio in ABS

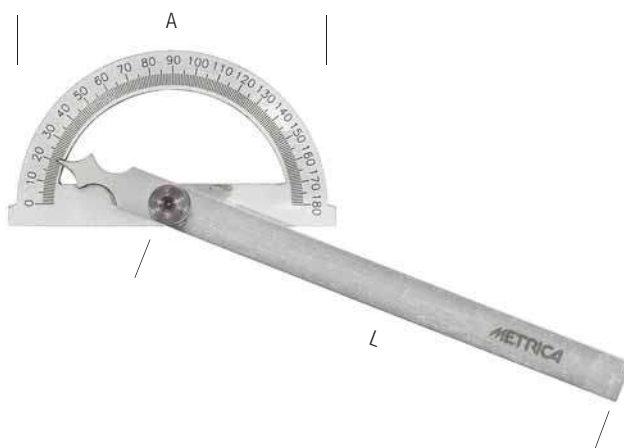

GONIOMETRO SEMPLICE

Ref.	A mm	L mm	Barcode	Box	€
36511	∅ 80	120	8001066365111	1	-
36512	∅ 120	150	8001066365128	1	-
36513	∅ 150	200	8001066365135	1	-
36514	∅ 200	250	8001066365142	1	-

- In acciaio con ghiera di bloccaggio
- Capacità 0-180°
- Scala cromata
- Lettura 1°

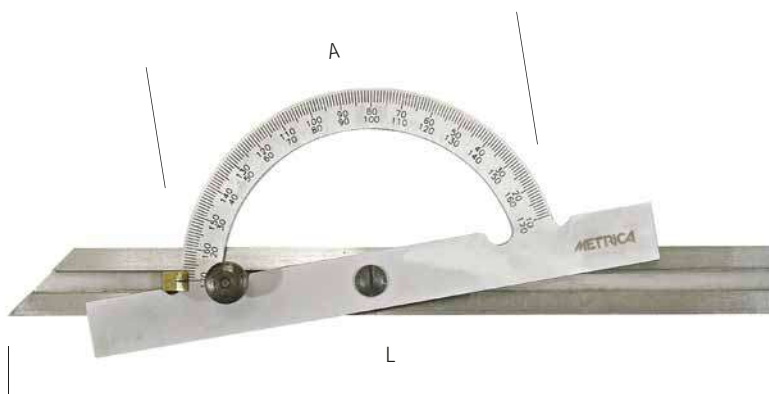

GONIOMETRO AD ASTA SCORREVOLE

Ref.	A mm	L mm	Barcode	Box	€
36540	∅ 120	240	8001066365401	1	-
36541	∅ 150	300	8001066365418	1	-
36542	∅ 200	400	8001066365425	1	-
36543	∅ 250	500	8001066365432	1	-

- In acciaio
- Capacità 0-170°
- Asta scorrevole con bloccaggio
- Scala cromata
- Lettura 1°

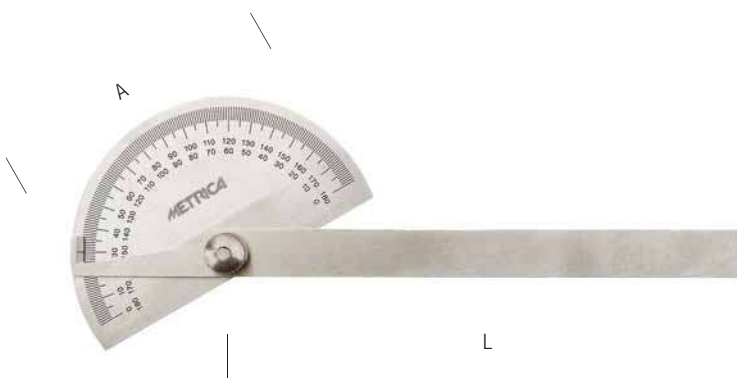

GONIOMETRO INOX

Ref.	A mm	L mm	Barcode	Box	€
36500	∅ 90	150	8001066365005	1	-

- In acciaio
- Con ghiera di bloccaggio
- Capacità 0-180°
- Doppia scala 0-180°/180°-0
- Lettura 1°



“4 IN 1” GONIOMETRO MULTIFUNZIONE

Ref.	∅	A			€
36550	240 mm	500 mm	8001066365500	5	–

- Goniometro multifunzione in acciaio
- Utile per guidare il taglio, per tracciare cerchi e righe parallele, per calibrare distanze

A



FALSA SQUADRA

Ref.	A	B			€	Ref.			€
69665	150 mm	250 mm	8001066696659	5	–	09665	8001066096657	5	–

- Asta graduata scorrevole in acciaio
- Base in alluminio

A

METRICA

B

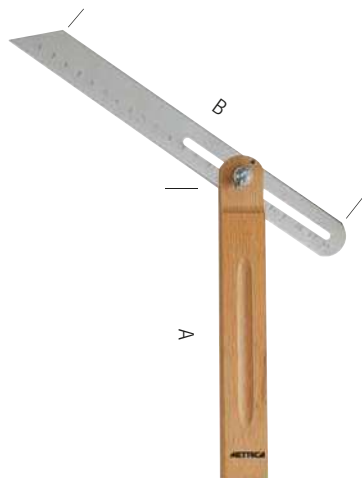

FALSA SQUADRA

Ref.	A	B			€	Ref.			€
69650	150 mm	250 mm	8001066696505	5	–	09650	8001066096503	5	–

- Asta graduata scorrevole in acciaio
- Graduazione 240 mm
- Base in legno, bloccaggio a galletto

A

METRICA

B



FALSA SQUADRA

Ref.	A	B			€
09662	150 mm	250 mm	8001066096626	5	–

- Asta graduata scorrevole in acciaio
- Graduazione 240 mm
- Base in ABS, bloccaggio a galletto

A

METRICA

B



02

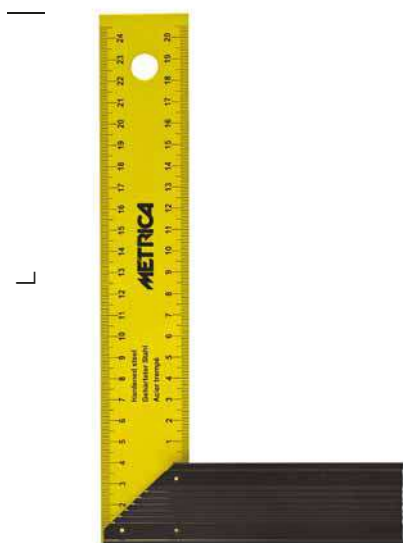

SQUADRA PROFESSIONALE PER FALEGNAME

Ref.	L			€
29232	200 mm	8001066292325	5	–
29233	250 mm	8001066292332	5	–
29234	300 mm	8001066292349	5	–
29235	350 mm	8001066292356	5	–
29236	400 mm	8001066292363	5	–
29237	500 mm	8001066292370	5	–

- Lama in acciaio temprato gialla graduata
- Base in alluminio estruso anodizzato nero



SQUADRA PROFESSIONALE PER FALEGNAME

Ref.	L			€
29252	200 mm	8001066292523	5	–
29253	250 mm	8001066292530	5	–
29254	300 mm	8001066292547	5	–
29255	350 mm	8001066292554	5	–
29256	400 mm	8001066292561	5	–
29257	500 mm	8001066292578	5	–

- Lama in acciaio temprato bianca graduata
- Base in alluminio estruso anodizzato nero

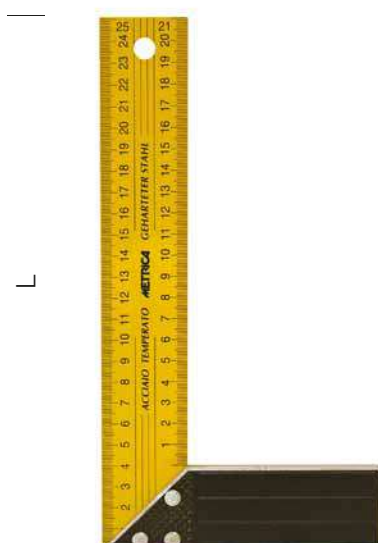

SQUADRA PER FALEGNAME

Ref.	L			€	Ref.			€
29240	150 mm	8001066292400	5	–	06240	8001066062409	5	–
29241	200 mm	8001066292417	5	–	06241	8001066062416	5	–
29242	250 mm	8001066292424	5	–	09242	8001066092420	5	–
29243	300 mm	8001066292431	5	–	09243	8001066092437	5	–
29244	350 mm	8001066292448	5	–	09244	8001066092444	5	–
29245	400 mm	8001066292455	5	–	09245	8001066092451	5	–
29247	500 mm	8001066292479	5	–	09247	8001066092475	5	–

- Lama in acciaio temprato
- Base in alluminio fuso

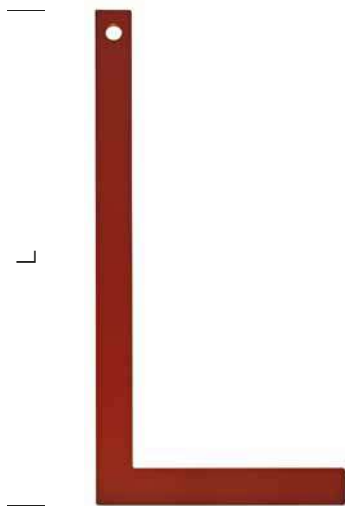

SQUADRA PER CARPENTIERE RIGIDA

Ref.	L			€
29354	400 mm	8001066293544	5	–
29355	500 mm	8001066293551	5	–
29356	600 mm	8001066293568	5	–
29357	700 mm	8001066293575	5	–
29358	800 mm	8001066293582	5	–
29359	1000 mm	8001066293599	5	–

■ Squadra rigida in acciaio verniciato

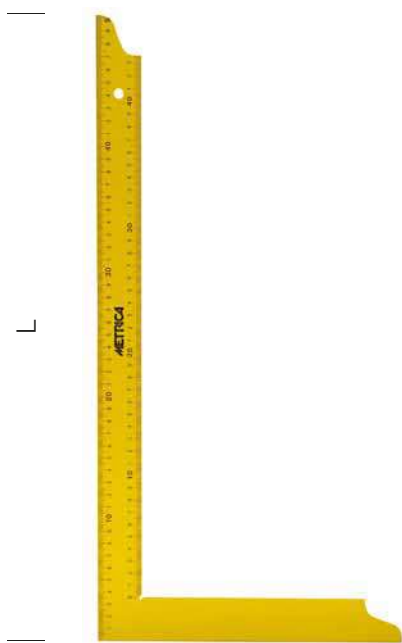

SQUADRA PER CARPENTIERE FLESSIBILE

Ref.	L			€
29301	500 mm	8001066293018	5	–
29302	600 mm	8001066293025	5	–
29303	700 mm	8001066293032	5	–
29304	800 mm	8001066293049	5	–
29305	1000 mm	8001066293056	5	–

■ Acciaio temprato flessibile

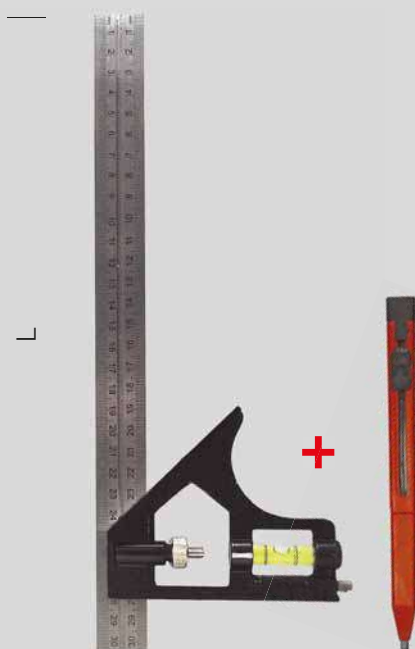

SQUADRA COMBINATA

Ref.	L			€
29502	300 mm	8001066295029	5	–

- Lama scorrevole graduata in acciaio cromato
- Base in alluminio con fiala e punta a tracciare
- In blister con matita 18 cm





SQUADRA PER FALEGNAME LAMA INOX

Ref.	L			€
29219	250 mm	8001066292196	1	-
29220	300 mm	8001066292202	1	-
29221	400 mm	8001066292219	1	-
29222	500 mm	8001066292226	1	-

- Lama in acciaio INOX temprato
- Base in alluminio anodizzato estruso
- Scala incisa

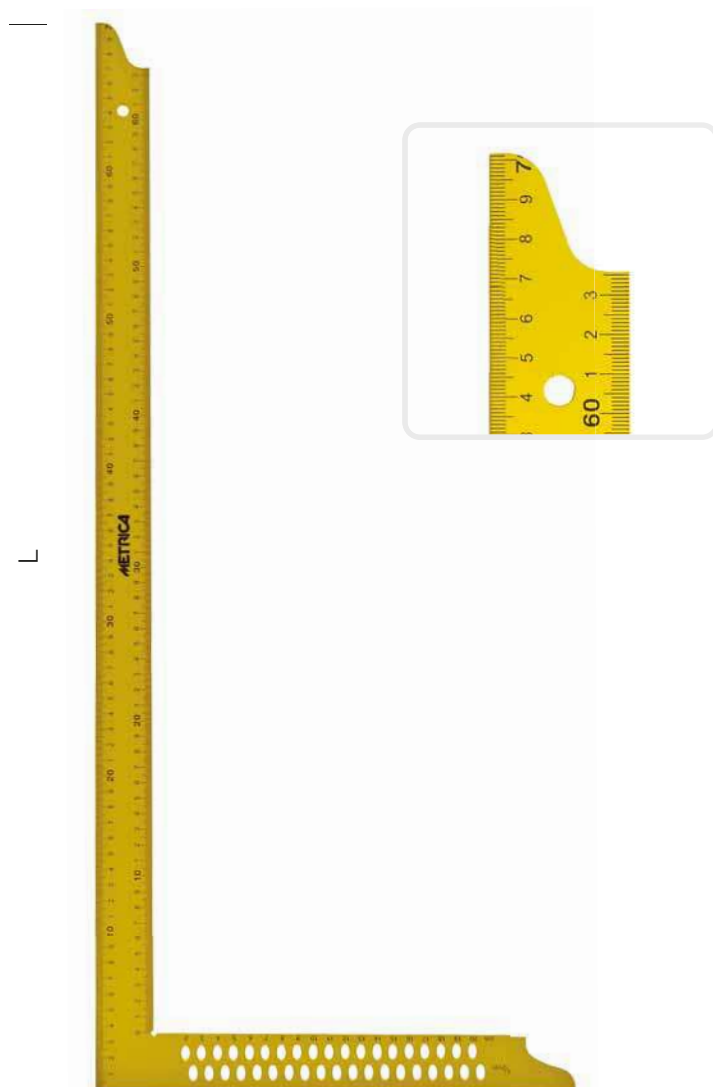





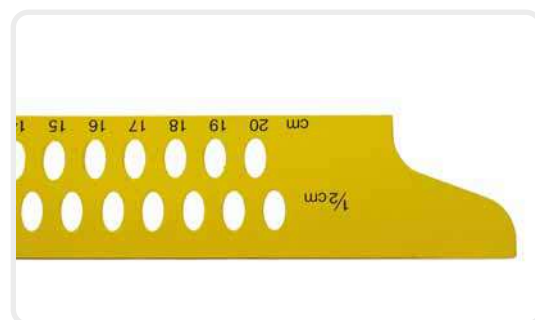

SQUADRA PER CARPENTIERE CON FORI

Ref.	L			€
29320	700 mm	8001066293209	1	-
29321	800 mm	8001066293216	1	-
29322	900 mm	8001066293223	1	-
29323	1000 mm	8001066293230	1	-











- Acciaio temprato flessibile
- Base con fori ogni 0,5 cm















		LUNGHEZZA (cm)										PRECISIONE mm/m	NUMERO DI FIALE	MATERIALE			BASE		TAPPO													
		< 25 cm	25 cm	30 cm	40 cm	50 cm	60 cm	80 cm	100 cm	120 cm	150 cm			180 cm	200 cm	ALLUMINIO	PLASTICA	RESINA ACRILICA	PRISMATICA	GRADUATA	MAGNETICA	GOMMA ANTIURTO	IN PLASTICA									
 <p>formula INVISIBLE</p> <p>pag. 150</p>	Ref. 32754				●									0,5 mm/m	2	●			●				●									
	Ref. 32755				●	●																										
	Ref. 32756					●	●																									
	Ref. 32758							●																								
 <p>megalevel INVISIBLE</p> <p>pag. 150</p>	Ref. 32937				●								0,5 mm/m	2	●								●									
	Ref. 32939						●																									
Ref. 32941								●																								
 <p>formula INVISIBLE</p> <p>pag. 151</p>	Ref. 32834				●								0,5 mm/m	2	●																	
	Ref. 32835					●																										
	Ref. 32836						●																									
	Ref. 32838							●																								
	Ref. 32840								●																							
	Ref. 32842									●																						
	Ref. 32837										●																					
	Ref. 32839											●																				
	Ref. 32841																						●									
	 <p>formula INVISIBLE</p> <p>pag. 151</p>	Ref. 32224				●																		0,5 mm/m	2	●						
Ref. 32225						●																										
Ref. 32226							●																									
Ref. 32228								●																								
Ref. 32230									●																							
Ref. 32232										●																						
Ref. 32365											●																					
Ref. 32368												●																				
Ref. 32370													●																			
 <p>METRICA FLASH</p> <p>pag. 152</p>		Ref. 33130		●										0,5 mm/m	2	●																
	Ref. 33134			●																												
	Ref. 33135				●																											
	Ref. 33136					●																										
	Ref. 33138						●																									
	Ref. 33140							●																								
	Ref. 33141								●																							
	Ref. 33142									●																						
	Ref. 33145										●																					
	Ref. 33150											●																				
	Ref. 33304				●								0,5 mm/m											3	●							
	Ref. 33305					●																										
	Ref. 33306						●																									
	Ref. 33308							●																								
	Ref. 33310								●																							
Ref. 33312									●																							
Ref. 33315										●																						
Ref. 33318											●																					
Ref. 33320												●																				
 <p>METRICA FLASH XL</p> <p>pag. 153</p>	Ref. 33164				●								0,5 mm/m	2	●																	
	Ref. 33165					●																										
	Ref. 33166						●																									
	Ref. 33168							●																								
	Ref. 33170								●																							
	Ref. 33172									●																						
	Ref. 33175										●		0,5 mm/m	2	●																	
	Ref. 33178											●																				
	Ref. 33180																					●										
	Ref. 33194					●								0,5 mm/m	3	●																
Ref. 33195						●																										
Ref. 33196							●																									
Ref. 33198								●																								
Ref. 33200									●																							
Ref. 33202										●																						
Ref. 33205											●	0,5 mm/m	3	●																		
Ref. 33208																					●											
Ref. 33210																						●										



02

	LUNGHEZZA (cm)											PRECISIONE mm/m	NUMERO DI FIALE	MATERIALE			BASE		TAPPO		
	< 25 cm	25 cm	30 cm	40 cm	50 cm	60 cm	80 cm	100 cm	120 cm	150 cm	180 cm			200 cm	ALLUMINIO	PLASTICA	RESINA ACRILICA	PRISMATICA	GRADUATA	MAGNETICA	GOMMA ANTIURTO
METRICA FLASH XL  pag. 153					●	●		●					0,5 mm/m	2	●					●	
Ref. 33185 Ref. 33186 Ref. 33182 Ref. 33183									●				0,5 mm/m	3	●					●	
 pag. 154				●	●	●	●						0,5 mm/m	2	●		●				●
formula Ref. 32704 Ref. 32705 Ref. 32706 Ref. 32708 Ref. 32710				●	●	●	●	●					0,5 mm/m	3	●		●				●
 pag. 154				●	●	●	●	●					0,5 mm/m	3	●		●				●
formula Ref. 32734 Ref. 32735 Ref. 32736 Ref. 32738 Ref. 32740				●	●	●	●	●					0,5 mm/m	2	●					●	
 pag. 155				●	●	●	●	●					0,5 mm/m	3	●					●	
formula Ref. 32804 Ref. 32805 Ref. 32806 Ref. 32808 Ref. 32810				●	●	●	●	●	●				0,5 mm/m	3	●					●	
 pag. 155				●	●	●	●	●	●	●			0,5 mm/m	2	●					●	
formula Ref. 32844 Ref. 32845 Ref. 32846 Ref. 32848 Ref. 32850 Ref. 32852 Ref. 32855 Ref. 32858 Ref. 32860				●	●	●	●	●	●	●	●		0,5 mm/m	3	●					●	
megalevel  pag. 156		●		●	●	●	●	●	●	●			0,5 mm/m	2	●					●	
Ref. 32293 Ref. 32294 Ref. 32295 Ref. 32296 Ref. 32298 Ref. 32300 Ref. 32302 Ref. 32290 Ref. 32291 Ref. 32292		●		●	●	●	●	●	●	●	●		0,5 mm/m	3	●					●	
megalevel  pag. 156				●	●	●	●	●					0,5 mm/m	2	●					●	
Ref. 32304 Ref. 32305 Ref. 32306 Ref. 32308 Ref. 32310				●	●	●	●	●	●				0,5 mm/m	3	●					●	
LIVELLA PRESSOFUSA IN ALLUMINIO  pag. 157			●	●	●	●	●	●					0,5 mm/m	2	●						
Ref. 31084 Ref. 31085 Ref. 31086 Ref. 31088 Ref. 31090			●	●	●	●	●	●	●				0,5 mm/m	2	●						
LIVELLA PRESSOFUSA IN ALLUMINIO  pag. 157			●	●	●	●	●	●					0,5 mm/m	2	●			●			
Ref. 31094 Ref. 31095 Ref. 31096 Ref. 31098			●	●	●	●	●	●					0,5 mm/m	2	●			●			
LIVELLA TRAPEZIA PRESSOFUSA  pag. 158	●	●		●	●	●	●	●					0,5 mm/m	2	●						
Ref. 31072 Ref. 31073 Ref. 31074 Ref. 31075 Ref. 31076 Ref. 31078 Ref. 31080	●	●		●	●	●	●	●					0,5 mm/m	2	●						

	LUNGHEZZA (cm)											PRECISIONE mm/m	NUMERO DI FIALE	MATERIALE			BASE		TAPPO		
	< 25 cm	25 cm	30 cm	40 cm	50 cm	60 cm	80 cm	100 cm	120 cm	150 cm	180 cm			200 cm	ALLUMINIO	PLASTICA	RESINA ACRILICA	PRISMATICA	GRADUATA	MAGNETICA	GOMMA ANTIURTO
LIVELLA TRAPEZIA PRESSOFUSA  pag. 158 Ref. 31062 Ref. 31063 Ref. 31064 Ref. 31065 Ref. 31066		●	●	●	●	●							1 mm/m	2	●					●	
LIVELLA GRADUATA IN ALLUMINIO PROFILATO  pag. 158 Ref. 32163 Ref. 32164 Ref. 32165 Ref. 32166 Ref. 32168 Ref. 32170			●	●	●	●	●	●					1 mm/m	2	●				●		●
LIVELLA GRADUATA IN ALLUMINIO PROFILATO  pag. 158 Ref. 32204 Ref. 32205 Ref. 32206 Ref. 32208 Ref. 32210				●	●	●	●	●	●				1 mm/m	3	●				●		●
LIVELLA GRADUATA IN ALLUMINIO PROFILATO  pag. 159 Ref. 32543 Ref. 32544 Ref. 32545 Ref. 32546 Ref. 32548 Ref. 32550 Ref. 32551 Ref. 32552 Ref. 32553 Ref. 32554			●	●	●	●	●	●	●	●	●	●	1 mm/m	2	●				●		●
LIVELLA GRADUATA IN ALLUMINIO PROFILATO  pag. 159 Ref. 32563 Ref. 32564 Ref. 32565 Ref. 32566 Ref. 32568 Ref. 32570			●	●	●	●	●	●	●	●			1 mm/m	3	●				●		●
LIVELLA GRADUATA IN ALLUMINIO PROFILATO  pag. 159 Ref. 32214x Ref. 32216x Ref. 32218x				●		●	●	●					1 mm/m	2	●				●	●	●
LIVELLA GONIOMETRICA  pag. 160						●	●							1	●						●
LIVELLA PER ELETTRICISTI  pag. 160	●													2	●						●
MINILIVELLA TASCABILE 1 FIALA  pag. 160	●													1	●						●
MINILIVELLA TASCABILE 2 FIALE  pag. 160	●													2			●				
MINILIVELLA TASCABILE IN ABS  pag. 161	●													2	●						
LIVELLA TASCABILE MAGNETICA  pag. 161	●													3	●				●		
MINI LIVELLA PER FILI  pag. 161	●													1	●				●		

02

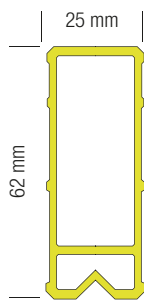

formula **IN**VISIBLE

LIVELLA PRISMATICA MAGNETICA

Ref.	L cm	•	U	Barcode	Box	€
32754	40	•	•	8001066327546	3	-
32755	50	•	•	8001066327553	3	-
32756	60	•	•	8001066327560	3	-
32758	80	•	•	8001066327584	1	-

= magneti invisibili

- **Magneti Invisibili incorporati nella base prismatica**
- Base senza apertura, facilmente pulibile
- Resta appesa in ogni posizione: su superfici piane, in verticale, su superfici arrotondate
- Autocentrante su tubazioni e spigoli di travi in ferro o pilastri in cemento armato
- Per lavorare con le mani libere
- Fiale acriliche antiurto
- **Precisione 0,50 mm/m**
- Garanzia 5 anni

VANTAGGI DELLA BASE PRISMATICA

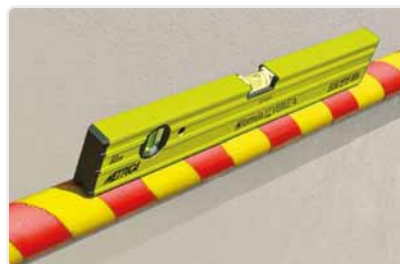
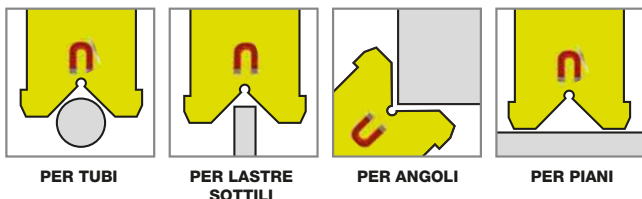

megalevel **IN**VISIBLE

MULTIMAGNETI

Ref.	L cm	•	U	Barcode	Box	€
32937	40	•	6	8001066329366	1	-
32939	60	•	7	8001066329380	1	-
32941	80	•	7	8001066329403	1	-

= magneti invisibili

- **Livella con 2 magneti invisibili incorporati nella base e 4 sulla faccia retrostante**
- Permette di **lavorare con mani libere**
- Fiale acriliche ad alta visibilità
- Precisione 0,50 mm/m
- Garanzia 5 anni

formula **IN**VISIBLE

LIVELLA MAGNETICA

Ref.	L cm					€
32834	40	•	•	8001066328345	3	–
32835	50	•	•	8001066328352	3	–
32836	60	•	•	8001066328369	3	–
32838	80	•	•	8001066328383	1	–
32840	100	•	•	8001066328406	1	–
32842	120	•	•	8001066328420	1	–
32837	150	•	•	8001066328376	1	–
32839	180	•	•	8001066328390	1	–
32841	200	•	•	8001066328413	1	–

= magneti invisibili

■ Magneti Invisibili incorporati nella base

- Base senza apertura, facilmente pulibile
- Magneti molto forti, resistenti agli urti e vibrazioni
- Per lavorare con le mani libere
- Fiale acriliche antiurto
- Tappi in gomma
- **Precisione 0,50 mm/m**
- Garanzia: 5 anni



TAPPO IN GOMMA ANTIURTO



MAGNETE INVISIBILE INTERNO

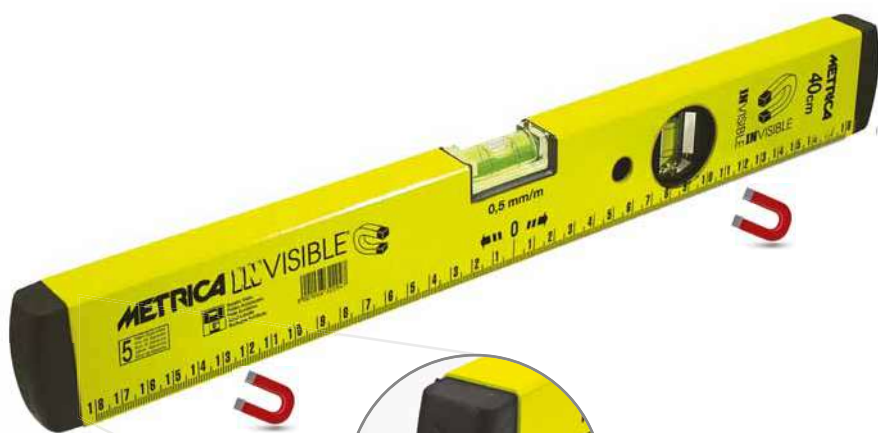
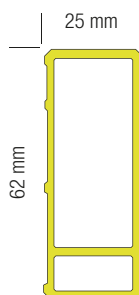

TAPPO IN GOMMA ANTIURTO



MAGNETE INVISIBILE INTERNO

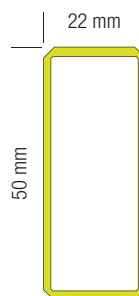

megalevel **IN**VISIBLE

LIVELLA MAGNETICA

Ref.	L cm					€
32224	40	•	•	8001066322244	6	–
32225	50	•	•	8001066322251	6	–
32226	60	•	•	8001066322268	6	–
32228	80	•	•	8001066322282	3	–
32230	100	•	•	8001066322305	3	–
32232	120	•	•	8001066322329	1	–
32365	150	•	•	8001066323654	1	–
32368	180	•	•	8001066323685	1	–
32370	200	•	•	8001066323708	1	–

= magneti invisibili

■ Magneti Invisibili incorporati nella base

- Base senza apertura, facilmente pulibile.
- Magneti molto forti, resistenti agli urti e vibrazioni
- Per lavorare con le mani libere
- Fiale acriliche antiurto
- Tappi in gomma
- **Precisione 0,50 mm/m**
- Garanzia: 5 anni

METRICA FLASH 0,50 mm/m - Garanzia fiale 10 anni

Ref.	L cm	●	8001066331307	6	€	Ref.	L cm	●	8001066333042	6	€
33130	30	●	8001066331307	6	-	33304	40	●	8001066333042	6	-
33134	40	●	8001066331345	6	-	33305	50	●	8001066333059	6	-
33135	50	●	8001066331352	6	-	33306	60	●	8001066333066	6	-
33136	60	●	8001066331369	6	-	33308	80	●	8001066333080	6	-
33138	80	●	8001066331383	3	-	33310	100	●	8001066333103	3	-
33140	100	●	8001066331406	3	-	33312	120	●	8001066333127	3	-
33141	120	●	8001066331413	1	-	33315	150	●	8001066333158	1	-
33142	150	●	8001066331420	1	-	33318	180	●	8001066333189	1	-
33145	180	●	8001066331451	1	-	33320	200	●	8001066333202	1	-
33150	200	●	8001066331505	1	-						

- Spessore maggiorato, peso 0,55 kg/m
- Fiale acriliche antiurto con 4 anelli (0° - 2%) con base fluorescente
- Tappi in gomma



TAPPO IN GOMMA ANTIURTO



KIT ESPOSITORI LIVELLE

METRICA FLASH

- Espositore composto da 30 pezzi livelle Flash

Ref.	8001066980567	1	€	Pz	Ref.	L cm
98056	8001066980567	1	-	6	33134	40
				6	33135	50
				6	33136	60
				6	33138	80
				6	33140	100



METRICA FLASH XL 0,30 mm/m - Garanzia fiale 10 anni



TAPPO IN GOMMA ANTIURTO

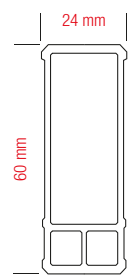

- Spessore maggiorato, peso **0,9 kg/m sezione** con doppia barra interna di rinforzo
- Fiale acriliche antiurto con **4 anelli** (0° - 2%) con base fluorescente
- Tappi in gomma

Ref.	L cm	●	■	€
33164	40	●	■	3 -
33165	50	●	■	3 -
33166	60	●	■	3 -
33168	80	●	■	1 -
33170	100	●	■	1 -
33172	120	●	■	1 -

Ref.	L cm	●	■	€
33194	40	●	■	3 -
33195	50	●	■	3 -
33196	60	●	■	3 -
33198	80	●	■	1 -
33200	100	●	■	1 -
33202	120	●	■	1 -



Ref.	L cm	●	■	€
33175	150	●	■	1 -
33178	180	●	■	1 -
33180	200	●	■	1 -

Ref.	L cm	●	■	€
33205	150	●	■	1 -
33208	180	●	■	1 -
33210	200	●	■	1 -

METRICA FLASH XL 0,30 mm/m - Garanzia fiale 10 anni



TAPPO IN GOMMA ANTIURTO



- Con maniglie
- Spessore maggiorato, peso **0,9 kg/m sezione** con doppia barra interna di rinforzo
- **Due piani fresati** (escluso 150/180/200 cm)
- Fiale acriliche antiurto con **4 anelli** (0° - 2%) con base fluorescente
- Tappi in gomma
- 3 fiale, 1 orizzontale + 2 verticali (120/150/180/200 cm)

Ref.	L cm	●	■	€
33185	50	●	■	1 -
33186	60	●	■	1 -
33182	80	●	■	1 -
33183	100	●	■	1 -
33212	120	●	■	1 -



Ref.	L cm	●	■	€
33215	150	●	■	1 -
33218	180	●	■	1 -
33220	200	●	■	1 -

02

LIVELLA BASE PRISMATICA



Ref.	L cm	gr					€
32704	40	364	•		8001066327041	3	–
32705	50	455	•		8001066327058	3	–
32706	60	546	•		8001066327065	3	–
32708	80	728	•		8001066327089	1	–
32710	100	910	•		8001066327102	1	–
32734	40	364		•	8001066327348	3	–
32735	50	455		•	8001066327355	3	–
32736	60	546		•	8001066327362	3	–
32738	80	728		•	8001066327386	1	–
32740	100	910		•	8001066327409	1	–

- **Base prismatica:** ideale per tubi, spigoli e lastre sottili
- Sezione maggiorata 62 x 25 mm, peso 0,92 kg/m sezione
- Peso 0,92 kg/m
- **Barra interna di rinforzo** per un'estrema rigidità
- Doppia nervatura laterale per una presa sicura
- Base lavorata
- Fiale acriliche ad alta trasparenza
- Fiala centrale arrotondata per una perfetta visibilità da ogni angolazione
- **Indicazione diretta della pendenza 2% sulla fiala centrale**
- **Precisione 0,50 mm/m**
- Garanzia 5 anni

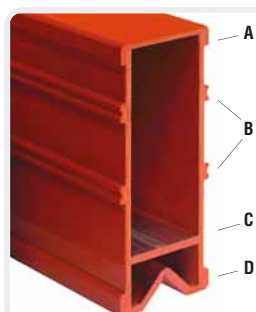

BASE PRISMATICA

- A: profilo pesante
- B: doppia nervatura
- C: barra interna di rinforzo
- D: base prismatica

VANTAGGI DELLA BASE PRISMATICA

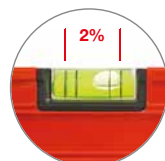
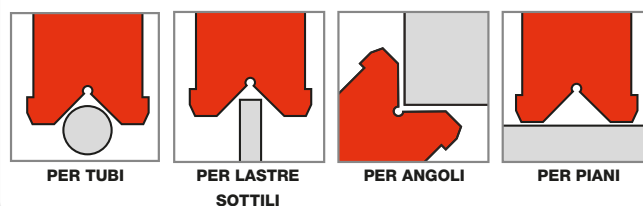

Fiala centrale con 4 tacche: per indicazione 0° (tacche interne) o per indicazione pendenza 2% (tacche esterne)

LIVELLA BASE PIANA

formula

Ref.	L cm	gr					€
32804	40	364	•		8001066328048	3	–
32805	50	455	•		8001066328055	3	–
32806	60	546	•		8001066328062	3	–
32808	80	728	•		8001066328086	1	–
32810	100	910	•		8001066328109	1	–
32844	40	364		•	8001066328444	3	–
32845	50	455		•	8001066328451	3	–
32846	60	546		•	8001066328468	3	–
32848	80	728		•	8001066328482	1	–
32850	100	910		•	8001066328505	1	–
32852	120	1092		•	8001066328529	1	–
32855	150	1365		•	8001066328550	1	–
32858	180	1638		•	8001066328581	1	–
32860	200	1820		•	8001066328604	1	–

- Base piana lavorata
- Sezione maggiorata 62 x 25 mm, peso 0,92 kg/m sezione
- **Barra interna di rinforzo** per un'estrema rigidità
- Doppia nervatura laterale per una presa sicura
- Tappi in gomma antiurto
- Fiale acriliche ad alta trasparenza
- Fiala centrale arrotondata per una perfetta visibilità da ogni angolazione
- **Indicazione diretta della pendenza 2% sulla fiala centrale**
- **Precisione 0,50 mm/m**
- Garanzia 5 anni

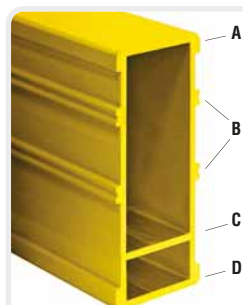
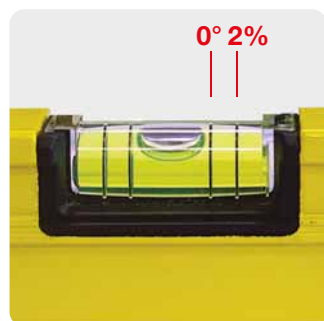

BASE NORMALE

- A: profilo pesante
- B: doppia nervatura
- C: barra interna di rinforzo
- D: base piana



TAPPO IN GOMMA ANTIURTO

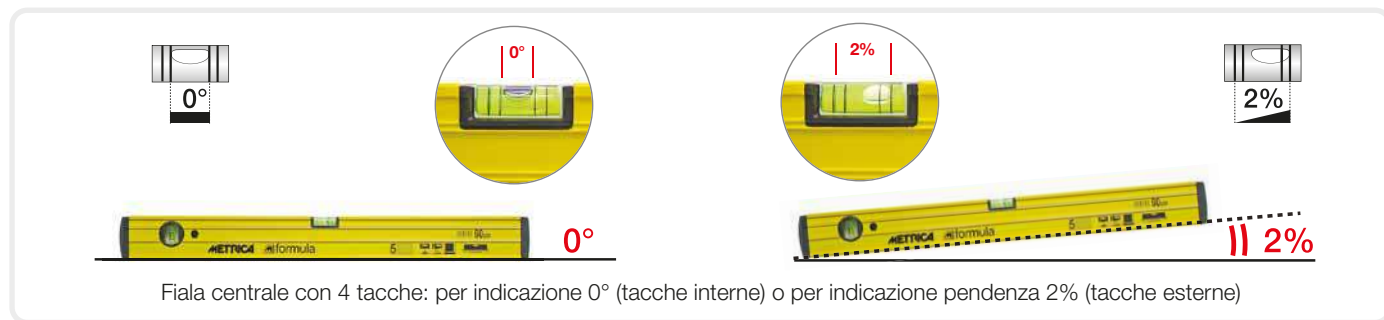

megalevel IN ALLUMINIO PROFILATO

Ref.	L cm					€
32293	30	•		8001066322930	6	-
32294	40	•		8001066322947	6	-
32295	50	•		8001066322954	6	-
32296	60	•		8001066322961	6	-
32298	80	•		8001066322985	3	-
32300	100	•		8001066323005	3	-
32302	120	•		8001066323029	3	-
32290	150	•		8001066322909	3	-
32291	180	•		8001066322912	3	-
32292	200	•		8001066322923	1	-
32304	40		•	8001066323043	6	-
32305	50		•	8001066323050	6	-
32306	60		•	8001066323067	6	-
32308	80		•	8001066323081	3	-
32310	100		•	8001066323104	3	-

- Base piana lavorata fresata
- Fiale acriliche resistenti agli urti
- Tappi in gomma antiurto
- Vernice epossidica
- Precisione 0,50 mm/m
- Garanzia 5 anni

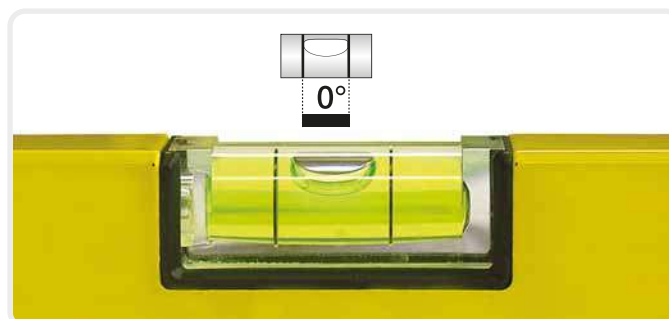





**ESPOSITORE
PER LIVELLE**
megalevel
30 pezzi

Ref.			€	Pz	Ref.	L cm	
98052	8001066980529	1	-	6	32294	40	8001066322947
				6	32295	50	8001066322954
				6	32296	60	8001066322961
				6	32298	80	8001066322985
				6	32300	100	8001066323005





LIVELLA PRESSOFUSA IN ALLUMINIO

BASE NORMALE

Ref.	L cm					€
31084	40	•		8001066310845	6	-
31085	50	•		8001066310852	6	-
31086	60	•		8001066310869	6	-
31088	80	•		8001066310883	3	-
31090	100	•		8001066310906	3	-



- Corpo massiccio sezione 50 x 24 mm
- **In alluminio pressofuso**
- Due piani fresati
- **Fiale acriliche** resistenti agli urti
- Fiale ad alta visibilità
- Precisione 0,5 mm/m
- Impugnatura ergonomica a partire da 50 cm

BASE MAGNETICA

Ref.	L cm					€
31094	40	•	•	8001066310944	6	-
31095	50	•	•	8001066310951	6	-
31096	60	•	•	8001066310968	6	-
31098	80	•	•	8001066310982	3	-





LIVELLA TRAPEZIA PRESSOFUSA BASE NORMALE

Ref.	L cm	gr				€
31072	25	270		8001066310722	6	-
31073	30	300		8001066310739	6	-
31074	40	380		8001066310746	6	-
31075	50	440		8001066310753	6	-
31076	60	600		8001066310760	6	-
31078	80	760		8001066310784	3	-
31080	100	940		8001066310807	3	-

- Corpo in alluminio pressofuso
- Profilo affusolato per lavorare anche negli angoli
- Fiale acriliche antiurto
- Base fresata







BASE MAGNETICA

Ref.	L cm	gr				€
31062	25	270	•	8001066310623	6	-
31063	30	300	•	8001066310630	6	-
31064	40	380	•	8001066310647	6	-
31065	50	440	•	8001066310654	6	-
31066	60	600	•	8001066310661	3	-







LIVELLA GRADUATA IN ALLUMINIO PROFILATO

Ref.	L cm					€
32163	30	•		8001066321636	6	-
32164	40	•		8001066321643	6	-
32165	50	•		8001066321650	6	-
32166	60	•		8001066321667	6	-
32168	80	•		8001066321681	3	-
32170	100	•		8001066321704	3	-
32204	40		•	8001066322046	6	-
32205	50		•	8001066322053	6	-
32206	60		•	8001066322060	6	-
32208	80		•	8001066322084	3	-
32210	100		•	8001066322107	3	-

- Livella in alluminio profilato
- Sezione 50 x 20 mm
- Base lavorata con graduazione
- Fiale acriliche resistenti agli urti
- Superficie verniciata
- Precisione 1 mm/m







LIVELLA GRADUATA IN ALLUMINIO PROFILATO

Ref.	L cm					€
32543	30	•		8001066325436	6	—
32544	40	•		8001066325443	6	—
32545	50	•		8001066325450	6	—
32546	60	•		8001066325467	6	—
32548	80	•		8001066325481	3	—
32550	100	•		8001066325504	3	—
32551	120	•		8001066325511	3	—
32552	150	•		8001066325528	3	—
32553	180	•		8001066325535	1	—
32554	200	•		8001066325542	1	—
32563	30		•	8001066325634	6	—
32564	40		•	8001066325641	6	—
32565	50		•	8001066325658	6	—
32566	60		•	8001066325665	6	—
32568	80		•	8001066325689	3	—
32570	100		•	8001066325702	3	—

- Livella in alluminio profilato pratica e leggera
- Base con graduazione
- Fiale acriliche resistenti agli urti
- Superficie anodizzata
- Precisione 1 mm/m



LIVELLA GRADUATA IN ALLUMINIO PROFILATO CON BASE MAGNETICA

Ref.	L cm					€
32214x	40	•	2	8001066322145	6	—
32216x	60	•	2	8001066322169	6	—
32218x	80	•	2	8001066322183	3	—

 = numero di magneti

- Livella in alluminio profilato pratica e leggera
- **Base magnetica con graduazione**
- Fiale acriliche resistenti agli urti
- Superficie anodizzata
- Precisione 1 mm/m





LIVELLA GONIOMETRICA BASE NORMALE O MAGNETICA

Ref.	L cm	...	☐	📦	€
33226	60	1° - %	☐	8001066332267	1 -
33236	60	1° - %	•	8001066332366	1 -

- Livella goniometrica in alluminio profilato
- Disco graduato girevole con bloccaggio
- Lettura diretta dell'inclinazione in % e della pendenza in gradi

Ref. **33226**: base normale
Ref. **33236**: base magnetica



LIVELLA PER ELETTRICISTI

Ref.	L cm	H mm	📦	€
31024	20	50	8001066310241	1 -
31025	20	50	8001066310258	1 -

- Due file a acriliche resistenti agli urti
- 20 cm
- Tappi terminali in gomma
- In alluminio profilato

Ref. **31025**: base normale
Ref. **31024**: base magnetica



MINILIVELLA TASCABILE A 1 FIALA

Ref.	L cm	H mm	📦	€
31021	10	25	8001066310210	1 -

- Minilivella tascabile a 1 fiala
- 10 cm
- Alluminio profilato pieno

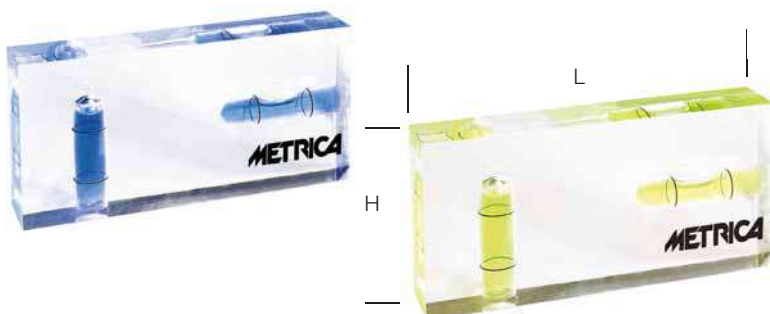

MINILIVELLA TASCABILE A 2 FIALE

Ref.	L cm	H mm	📦	€
33031	9,5	50	8001066330317	1 -
33032	9,5	50	8001066330324	1 -

- Trasparente a 2 file a
- L x H 9,5 x 5 cm
- In resina acrilica resistente agli urti

LIVELLA TASCABILE



Ref.	L cm		8001066330805	6	€	Ref.		8001066060801	10	€
33080	10	●	8001066330805	6	-	06080	8001066060801	10	-	-
33081	10	○	8001066330812	6	-	03081	8001066030811	10	-	-
33082	10	●	8001066330829	6	-	06082	8001066060825	10	-	-
33083	10	●	8001066330836	6	-	03083	8001066030835	10	-	-
33084	10	●	8001066330843	6	-	03084	8001066030842	10	-	-

- Livella tascabile in ABS
- Due fiale

LIVELLA TASCABILE

Ref.	L cm		8001066330010	10	€
33001	21	●	8001066330010	10	-

- Livella tascabile in ABS
- Tre fiale
- **Inclusa minilivella asportabile per fili**
- **Base magnetica**

Non in vendita in UK



MINILIVELLA PER FILI

Ref.	L cm	H mm	8001066330003	6	€
33000	5,5	2	8001066330003	6	-



- **Con incavo** passante **per fili**
- **Base magnetica**
- Una fiala

Non in vendita in UK



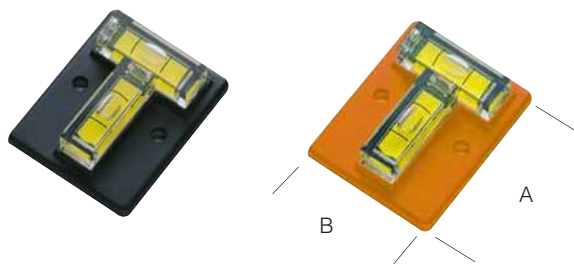

LIVELLINA A "T" PER PIANI

Ref.	A x B mm		8001066345519	6	€
34551	48 x 40	●	8001066345519	6	-
34550	48 x 40	●	8001066345502	6	-

■ Due file a T in resina acrilica

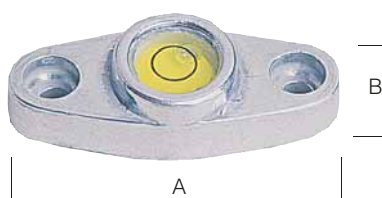

LIVELLINA PER BILANCE

Ref.	A x B mm		8001066345007	5	€
34500	47 x 18		8001066345007	5	-

■ Fiala acrilica
■ Supporto in metallo cromato



FIALE CIRCOLARI

Ref.	∅ mm		8001066345090	10	€
34509	11		8001066345090	10	-
34510	12		8001066345106	10	-
34511	12 / 30		8001066345113	10	-
34513	15		8001066345137	10	-
34514	20		8001066345144	10	-

■ Fiala acrilica

Ref. 34509 - 34510 - 34513 - 34514 senza supporto
Ref. 34511 con supporto diam. 30 mm



FIALE AD ALTA SENSIBILITÀ CIRCOLARI

Ref.	∅ mm		8001066345199	1	€
34519	40		8001066345199	1	-
34520	80		8001066345205	1	-
34521	56		8001066345212	1	-

■ Fiala graduata a cerchi concentrici
■ Sensibilità 5 - 40'
■ In resina acrilica

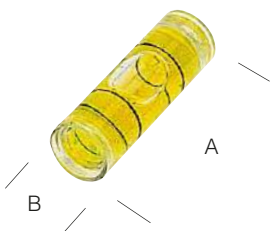

FIALE SCIOLTE

Ref.	A x B mm		8001066329205	50	€
32920	30 x 9,5		8001066329205	50	-

■ Fiale in plastica antiurto
■ Misure speciali a richiesta

LIVELLE AD ACQUA

Ref.	Barcode	Box	€	Ref.	Barcode	Box	€
34030	8001066340309	1	-	04030	8001066040308	5	-

- Coppia di tubi graduati
- Rubinetti in plastica
- Scala 0-12 cm
- Lettura 1 mm



**TUBO IN PLASTICA
PER LIVELLA AD ACQUA**

Ref.	Barcode	Box	€
34100	8001066341009	1	-

- Tubo in plastica lunghezza **10 m**



**INCLINOMETRO
E LIVELLA DIGITALE**

Ref.	A mm	B mm	Barcode	Box	€
60296	53	192	8001066602964	1	-

- Inclinometro digitale per misure assolute e relative
- Capacità: 0-360°
- Risoluzione: 0,1°
- 4 Superfici di misura
- Pulsanti: Hold (blocco), ON/OFF, ZERO (azzeramento)
- Batteria: CR2032

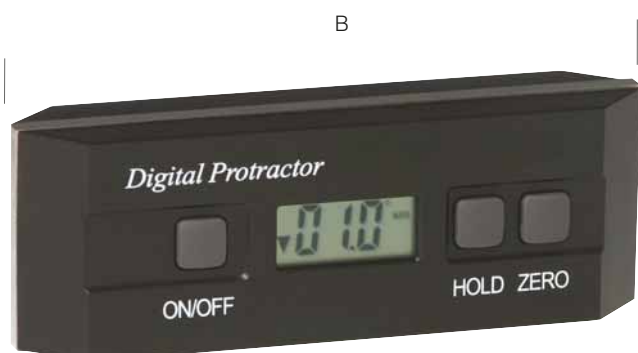

02

STAGGIA DI LIVELLAMENTO IN ALLUMINIO PROFESSIONALE

Ref.	L cm	A x B mm			€
32670	100	100 x 18	8001066326709	5	-
32671	150	100 x 18	8001066326716	5	-
32672	180	100 x 18	8001066326723	5	-
32673	200	100 x 18	8001066326730	5	-
32674	250	100 x 18	8001066326747	5	-
32675	300	100 x 18	8001066326754	5	-
32676	350	100 x 18	8001066326761	5	-
32677	400	100 x 18	8001066326778	5	-

- **Modello professionale**
- Staggia di livellamento con due impugnature
- Due fiale acriliche resistenti agli urti
- Sezione rettangolare 100 x 18 mm



STAGGIA DI LIVELLAMENTO IN ALLUMINIO

Ref.	L cm	A x B mm			€
32270	100	100 x 18	8001066322701	5	-
32271	150	100 x 18	8001066322718	5	-
32272	180	100 x 18	8001066322725	5	-
32273	200	100 x 18	8001066322732	5	-
32274	250	100 x 18	8001066322749	5	-
32275	300	100 x 18	8001066322756	5	-

- Sezione rettangolare 100 x 18 mm



STAGGIA SEMPLICE SENZA IMPUGNATURA

Ref.	L cm	A x B mm			€
32650	200	80 x 20	8001066326501	5	-
32651	250	80 x 20	8001066326518	5	-
32652	300	80 x 20	8001066326525	5	-
32653	350	80 x 20	8001066326532	5	-
32654	400	80 x 20	8001066326549	5	-



- Alluminio profilato sezione 80 x 20 mm
- Con tappi alle estremità

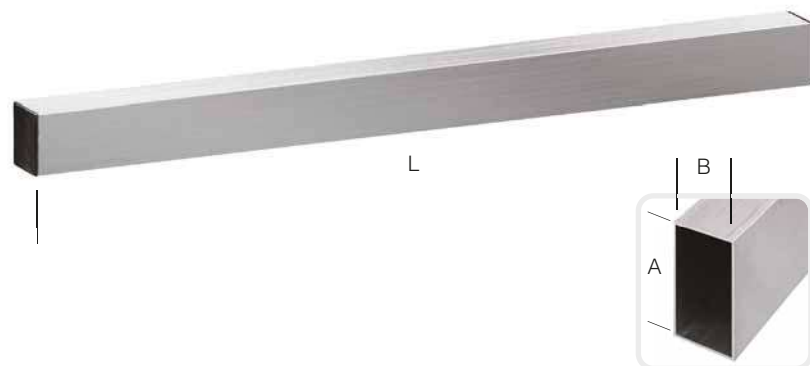

Ref.	L cm	A x B mm			€
32660	200	60 x 30	8001066326601	5	-
32661	250	60 x 30	8001066326617	5	-
32662	300	60 x 30	8001066326624	5	-
32663	350	60 x 30	8001066326631	5	-
32664	400	60 x 30	8001066326648	5	-

- Alluminio profilato sezione 60 x 30 mm
- Con tappi alle estremità



	LAMA					GUIDA LAMA		CORPO				BLOCCAGGI			ALTRE CARATTERISTICHE								
	4 mm	9 mm	18 mm	19 mm	25 mm	METALLICO	IN PLASTICA	CORPO IN ABS	CORPO METALLICO	IMPUGNATURA ANTISCIVOLO	RUBBER TOUCH	A ROTELLA	AUTOMATICO	DI SICUREZZA	LAMA A RIENTRO AUTOMATICO	LAMA DI RICAMBIO INCORPORATA	LAMA DI SICUREZZA	LAMA SPESSORE MAGGIORATO	MAGNETE RACCOGLILAME	PROFILO PIATTO	TRANCIALAME	COLORI ASSORTITI	
CUTTER BLACK BLADE pag. 167						●		●					●					●					
CUTTER BLACK BLADE PROFESSIONALE pag. 167						●				●				●				●					
CUTTER BLACK BLADE PROFESSIONALE GOMMATO pag. 167						●				●				●				●					
CUTTER PICCOLO pag. 168		●				●		●						●	●								
IMPUGNATURA IN GOMMA pag. 168		●				●		●		●	●												
CUTTER PIATTO pag. 168		●				●			●														
MINI CUTTER CON CLIP pag. 168		●					●	●						●						●			
INSTANT STOP pag. 169			●			●		●					●					●				●	
GRANDE PROFESSIONALE pag. 169			●			●		●		●				●				●					
IMPUGNATURA IN GOMMA pag. 169			●			●		●		●	●			●									
IMPUGNATURA IN GOMMA pag. 169			●			●		●		●	●			●	●								
CUTTER IN METALLO pag. 170			●			●			●	●	●			●									
IN METALLO PIATTO pag. 170			●			●			●					●						●			

	LAMA					GUIDA LAMA		CORPO				BLOCCAGGI			ALTRE CARATTERISTICHE								
	4 mm	9 mm	18 mm	19 mm	25 mm	METALLICO	IN PLASTICA	CORPO IN ABS	CORPO METALLICO	IMPUGNATURA ANTISCIVOLO	RUBBER TOUCH	A ROTELLA	AUTOMATICO	DI SICUREZZA	LAMA A RIENTRO AUTOMATICO	LAMA DI RICAMBIO INCORPORATA	LAMA DI SICUREZZA	LAMA SPESSORE MAGGIORATO	MAGNETE RACCOGLI LAME	PROFILO PIATTO	TRANCIALAME	COLORI ASSORTITI	
CUTTER GRANDE pag. 170			●			●		●				●											
METRICA QUICK RETURN pag. 170				●		●		●		●				●			●						
CUTTER DI SICUREZZA pag. 171			●			●			●	●		●		●	●	●							
CUTTER GRANDE pag. 171			●			●		●						●								●	
CUTTER MEDIO pag. 171			●				●	●						●								●	
CUTTER RUBBER 25 pag. 171					●	●		●		●	●	●			●		●	●	●				
RUBBER TOUCH 25 pag. 172					●	●		●		●	●	●							●				
CUTTER BIMATERIALE pag. 172				●			●	●		●	●			●									
CUTTER IN METALLO pag. 172				●		●			●					●									
CUTTER IN METALLO pag. 172				●		●			●					●									
CUTTER PER GRAFICA pag. 173	●					●		●							●								
RASCHIETTO pag. 173				●			●	●						●									
BOX MINICUTTER pag. 173		●					●	●							●								●

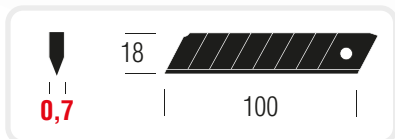

CUTTER BLACK BLADE

Ref.	L mm			€
09026	160	8001066090266	12	-

- Corpo in ABS (resistente)
- Guida lama metallico
- **Impugnatura antiscivolo** ergonomica
- **Lama nera** ultrasharp - SK4 - HRC > 65, spessore 0,7 mm
- **Durata** molto superiore (5 X)

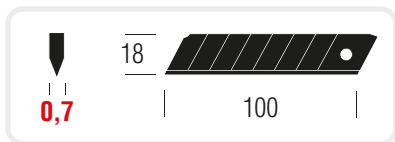

CUTTER BLACK BLADE PROFESSIONALE

Ref.	L mm			€
09028	185	8001066090280	12	-

- **Cutter professionale**
- Guida lama metallico
- **Impugnatura antiscivolo** ergonomica
- **Lama nera** ultrasharp - SK4 - HRC > 65, spessore 0,7 mm
- Regge **carico di punta** su lama pari a 60 Kg
- **Durata** molto superiore (5 X)

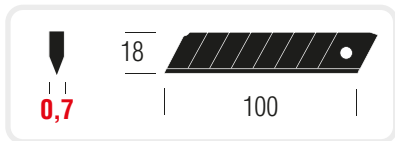

CUTTER BLACK BLADE PROFESSIONALE GOMMATO

Ref.	L mm			€
09029	185	8001066090297	12	-

- **Cutter professionale - corpo metallico**
- Guida lama metallico
- **Impugnatura gommata antiscivolo** ergonomica
- **Lama nera** ultrasharp - SK4 - HRC > 65, spessore 0,7 mm
- Regge **carico di punta** su lama pari a 60 Kg
- **Durata** molto superiore (5 X)

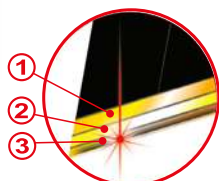
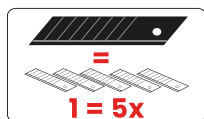

50% PIÙ AFFILATO.
TRIPLO ANGOLO
DI TAGLIO

BLACK BLADE

LAME DI RICAMBIO		Ref.			€
Dim. 100 x 18 x 0,7 mm - 10 pezzi		49036	8001066490363	10	-

- **Lama nera** ultrasharp - SK4 - HRC > 65, spessore 0,7 mm
- Regge **carico di punta** su lama pari a 60 Kg
- **Durata** molto superiore (5 X)
- Per Ref. 09026, Ref. 09028, Ref. 09029

02

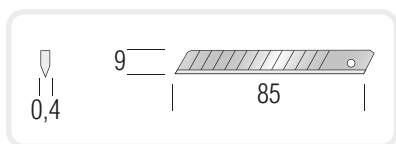

CUTTER PICCOLO

Ref.	L mm	Barcode	Box	€	Ref.	Barcode	Box	€
49030	135	8001066490301	10	-	06030	8001066060306	12	-

- Cutter professionale
- Bloccaggio di sicurezza
- Guida lama metallica
- 2 lame di ricambio incorporate

LAME DI RICAMBIO

Dim. 85 x 9 x 0,4 mm - 10 pezzi

Ref.	Barcode	Box	€
49031	8001066490318	10	-

RUBBERTOUCH

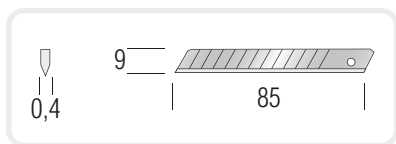

IMPUGNATURA IN GOMMA

Ref.	L mm	Barcode	Box	€
09102	140	8001066091027	12	-

- Guida lama metallico
- Impugnatura antiscivolo ergonomica bimateriale

LAME DI RICAMBIO

Dim. 85 x 9 x 0,4 mm - 10 pezzi

Ref.	Barcode	Box	€
49016	8001066490165	10	-

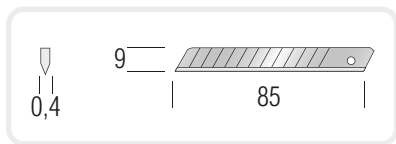

CUTTER PIATTO

Ref.	L mm	Barcode	Box	€	Ref.	Barcode	Box	€
49014	140	8001066490141	24	-	09014	8001066090143	12	-

- Cutter piatto
- Corpo metallico verniciato
- Bloccaggio di sicurezza

LAME DI RICAMBIO

Dim. 85 x 9 x 0,4 mm - 10 pezzi

Ref.	Barcode	Box	€
49016	8001066490165	10	-

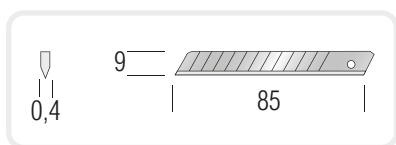

MINI CUTTER CON CLIP

Ref.	L mm	Barcode	Box	€	Ref.	Barcode	Box	€
49017	135	8001066490172	20	-	09017	8001066090174	6	-

- Minicutter con clip
- Corpo in ABS
- Bloccaggio di sicurezza
- Trancialame incorporato

LAME DI RICAMBIO

Dim. 85 x 9 x 0,4 mm - 10 pezzi

Ref.	Barcode	Box	€
49016	8001066490165	10	-



| L |

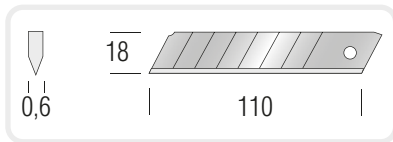

INSTANT STOP

Ref.	L mm	Barcode	Icon	€
09130	150	8001066091307	12	-

- Cutter professionale lama maggiorata spessore 0,6 mm
- Cutter con lama a **bloccaggio automatico** istantaneo
- Guida lama in metallo

LAME DI RICAMBIO

Ref.	Barcode	Icon	€
Dim. 110 x 18 x 0,6 mm - 10 pezzi ○ 49051	8001066490516	10	-
Dim. 110 x 18 x 0,6 mm - 10 pezzi ● 49061	8001066490615	10	-



| L |

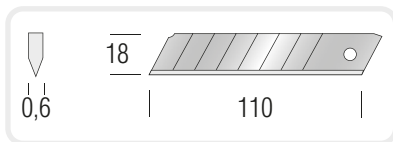

GRANDE PROFESSIONALE

Ref.	L mm	Barcode	Icon	€	Ref.	Barcode	Icon	€
49050	160	8001066490509	5	-	06050	8001066060504	12	-

- Cutter professionale impugnatura antiscivolo
- Corpo robusto in ABS, guida lama metallica
- Bloccaggio di sicurezza

LAME DI RICAMBIO

Ref.	Barcode	Icon	€
Dim. 110 x 18 x 0,6 mm - 10 pezzi ○ 49051	8001066490516	10	-
Dim. 110 x 18 x 0,6 mm - 10 pezzi ● 49061	8001066490615	10	-

RUBBERTOUCH



| L |

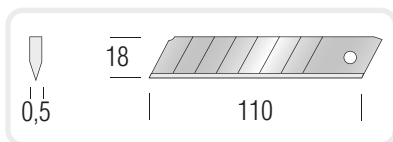

IMPUGNATURA IN GOMMA

Ref.	L mm	Barcode	Icon	€
09103	160	8001066091034	12	-

- Guida lama metallica
- Bloccaggio di sicurezza
- Impugnatura antiscivolo ed ergonomica bimateriale

LAME DI RICAMBIO

Ref.	Barcode	Icon	€	
Dim. 110 x 18 x 0,5 mm - 10 pezzi	49024	8001066490240	10	-

RUBBERTOUCH



| L |

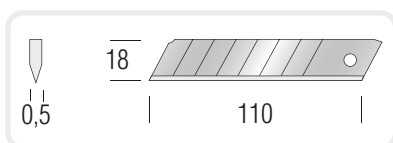

IMPUGNATURA IN GOMMA

Ref.	L mm	Barcode	Icon	€
09022	160	8001066090225	12	-

- Guida lama metallica
- Bloccaggio di sicurezza
- Impugnatura antiscivolo ed ergonomica bimateriale
- 2 lame di ricambio incorporate all'interno

LAME DI RICAMBIO

Ref.	Barcode	Icon	€	
Dim. 110 x 18 x 0,5 mm - 10 pezzi	49024	8001066490240	10	-

RUBBERTOUCH

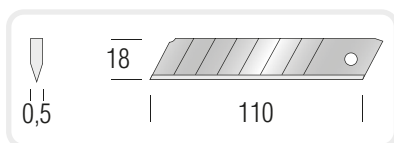

CUTTER IN METALLO

Ref.	L mm	Barcode	Icon	€
09056	170	8001066090560	6	-

- Guida lama metallica
- Bloccaggio di sicurezza
- **Corpo robusto in metallo**
- **Impugnatura antiscivolo**

LAME DI RICAMBIO		Icon	Ref.	Barcode	Icon	€
Dim. 110 x 18 x 0,5 mm - 10 pezzi			49024	8001066490240	10	-

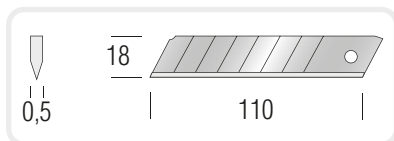

CUTTER METALLICO PIATTO

Ref.	L mm	Barcode	Icon	€	Ref.	Barcode	Icon	€
49012	140	8001066490127	10	-	09012	8001066090129	10	-

- Cutter **piatto**
- **Corpo in metallo**
- Bloccaggio di sicurezza

LAME DI RICAMBIO		Icon	Ref.	Barcode	Icon	€
Dim. 110 x 18 x 0,5 mm - 10 pezzi			49024	8001066490240	10	-

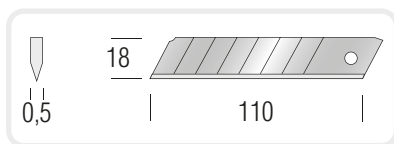

CUTTER GRANDE

Ref.	L mm	Barcode	Icon	€	Ref.	Barcode	Icon	€
49035	150	8001066490356	10	-	09035	8001066090358	12	-

- Guida lama metallica
- Con **rotella di bloccaggio** lama
- Corpo in ABS
- **Massima robustezza**

LAME DI RICAMBIO		Icon	Ref.	Barcode	Icon	€
Dim. 110 x 18 x 0,5 mm - 10 pezzi			49024	8001066490240	10	-

RUBBERTOUCH

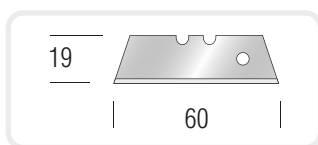
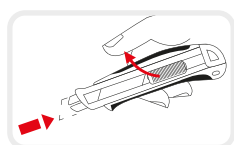

METRICA QUICK RETURN

Ref.	L mm	Barcode	Icon	€
09119	140	8001066091192	12	-

- **Cutter di sicurezza** con molla di **rientro automatico** della lama al rilascio
- Guida lama metallica
- Impugnatura ergonomica antiscivolo bimatereale

LAME DI RICAMBIO		Icon	Ref.	Barcode	Icon	€
Dim. 60 x 19 x 0,45 mm - 10 pezzi			49054	8001066490547	10	-



| L |

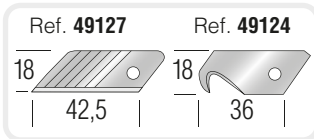
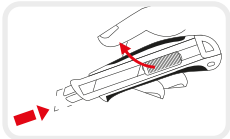

CUTTER DI SICUREZZA

Ref.	L mm	Barcode	Box	€
09121	145	8001066091215	6	-

- Cutter professionale di sicurezza
- Molla di rientro automatico lama a fine lavoro
- Guida lama e corpo in metallo
- Fornito con lama di ricambio standard e ad uncino

LAME DI RICAMBIO		Ref.	Barcode	Box	€
Dim. 42,5 x 18 x 0,45 mm - 10 pezzi	49127	8001066491278	10	-	
Dim. 36 x 18 x 0,45 mm - 3 pezzi	49124	8001066491247	10	-	



| L |

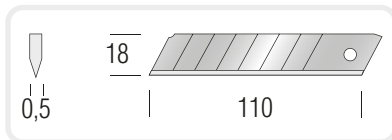

CUTTER GRANDE

Ref.	L mm	Barcode	Box	€	Ref.	Barcode	Box	€
49023	160	8001066490233	12	-	09023	8001066090232	12	-

- Guida lama in metallo
- Bloccaggio di sicurezza
- Massima robustezza
- Trancialame incorporato

LAME DI RICAMBIO		Ref.	Barcode	Box	€
Dim. 110 x 18 x 0,5 mm - 10 pezzi	49024	8001066490240	10	-	



| L |

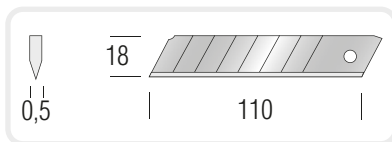

CUTTER MEDIO

Ref.	L mm	Barcode	Box	€	Ref.	Barcode	Box	€
49018	155	8001066490189	20	-	09018	8001066090181	12	-

- Corpo in ABS
- Bloccaggio di sicurezza
- Trancialame incorporato

LAME DI RICAMBIO		Ref.	Barcode	Box	€
Dim. 110 x 18 x 0,5 mm - 10 pezzi	49024	8001066490240	10	-	

RUBBERTOUCH



| L |

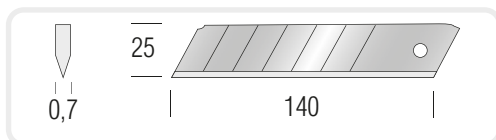

CUTTER RUBBER 25

Ref.	L mm	Barcode	Box	€
09104	180	8001066091041	6	-

- Guida lama in metallo
- Rotella di bloccaggio lama
- Magnete raccoglielame

LAME DI RICAMBIO		Ref.	Barcode	Box	€
Dim. 140 x 25 x 0,7 mm - 10 pezzi	49048	8001066490486	10	-	



METRICA RUBBER TOUCH 25

Ref.	L mm	Barcode	Icon	€
09045	180	8001066090454	12	-

- Cutter professionale - Lama sezione 25 x 0,7 mm
- 2 lame di ricambio incorporate
- Guida lama in metallo
- Rotella di bloccaggio lama
- Rivestimento antiscivolo
- Magnete raccogliilame

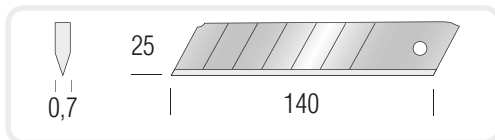

LAME DI RICAMBIO	Ref.	Barcode	Icon	€
Dim. 140 x 25 x 0,7 mm - 10 pezzi	49049	8001066490493	5	-

RUBBERTOUCH



CUTTER BIMATERIALE

Ref.	L mm	Barcode	Icon	€
09105	150	8001066091058	6	-

- Corpo in metallo e gomma antiscivolo
- Bloccaggio di sicurezza

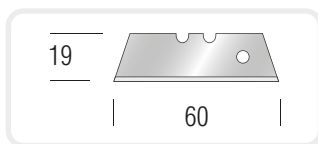

LAME DI RICAMBIO	Ref.	Barcode	Icon	€
Dim. 60 x 19 x 0,45 mm - 10 pezzi	49054	8001066490547	10	-



CUTTER IN METALLO

Ref.	L mm	Barcode	Icon	€
09106	150	8001066091065	6	-

- Cutter di sicurezza
- Molla di rientro automatico lama a fine lavoro
- Corpo in metallo

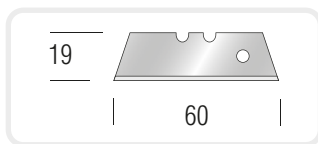
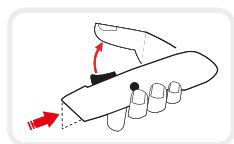

LAME DI RICAMBIO	Ref.	Barcode	Icon	€
Dim. 60 x 19 x 0,45 mm - 10 pezzi	49054	8001066490547	10	-



CUTTER IN METALLO

Ref.	L mm	Barcode	Icon	€	Ref.	Barcode	Icon	€
49117	160	8001066491179	6	-	09117	8001066091171	12	-

- Corpo in alluminio
- Lama regolabile in 10 posizioni
- Bloccaggio di sicurezza
- Forma ergonomica

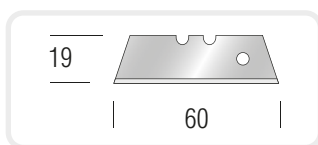

LAME DI RICAMBIO	Ref.	Barcode	Icon	€
Dim. 60 x 19 x 0,45 mm - 10 pezzi	49054	8001066490547	10	-



CUTTER PER GRAFICA



Ref.	L mm	Barcode	Box	€	Ref.	Barcode	Box	€
49052	140	8001066490523	1	-	09052	8001066090525	6	-

- Sgarzino tascabile con rientro lama
- 8 lame di ricambio incluse
- Con clip

LAME DI RICAMBIO		Barcode	Ref.	Box	€
Dim. 11 x 4 x 0,4 mm - 10 pezzi		8001066490530	09053	1	-



RASCHIETTO

Ref.	L mm	Barcode	Box	€	Ref.	Barcode	Box	€
49145	60	8001066491452	10	-	09145	8001066091454	10	-

- Raschietto multiuso
- Lama di sicurezza retrattile

LAME DI RICAMBIO		Barcode	Ref.	Box	€
Dim. 60 x 19 mm - 12 pezzi		8001066491513	49151	10	-



BOX MINICUTTER CON SICUREZZA

Ref.	L mm	Barcode	Box	€
49025	80	8001066490257	1	-

- Box da 50 pezzi in 3 colori assortiti
- Lama retrattile di sicurezza
- Catenella portachiavi

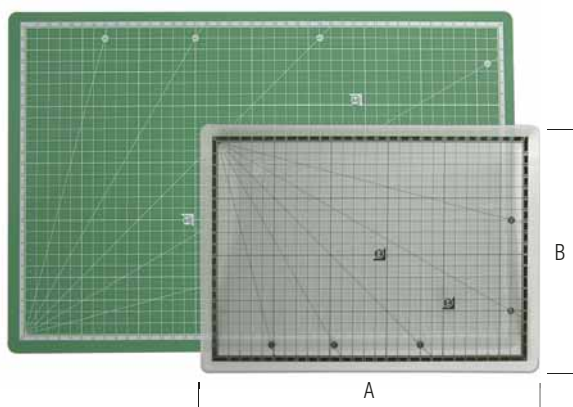

BASE DI LAVORO

Ref.	A x B mm	Color	Barcode	Box	€
72100	450 x 300	● Verde	8001066721009	1	-
72101	600 x 450	● Verde	8001066721016	1	-
72105	300 x 220	○ Trasparente	8001066721054	1	-

- Base di lavoro
- Tre strati sovrapposti di PVC
- Superficie interamente millimetrata

● Verde ○ Trasparente



TAGLIAVETRO JOBO

Ref.	L mm	Barcode	Box	€	Ref.	Barcode	Box	€
50503	155	8001066505036	12	-	00503	8001066005031	10	-

- Tagliavetro originale tedesco (mod. 320.0)
- 6 rotelle
- Manico in legno



TAGLIAVETRO

Ref.	Barcode	Box	€	Ref.	Barcode	Box	€
50500	8001066505005	12	-	00500	8001066005000	10	-

- Tagliavetro **originale Silberschnitt** (mod. 100.0)
- 6 rotelle
- Manico in legno



TAGLIAVETRO E TAGLIAPIASTRELLE

Ref.	Barcode	Box	€
50520	8001066505203	1	-

- Tagliavetro **originale Silberschnitt** (mod. 400.0)
- Rotellina in metallo duro diam. 5mm
- Manico in legno

RICAMBI

Rotella di ricambio mod. 402.135 - 1 PEZZO	Ref.	Barcode	Box	€
	50521	8001066505210	1	-



TAGLIAVETRO AD OLIO

Ref.	Barcode	Box	€
50505	8001066505050	1	-

- Tagliavetro ad olio **originale Silberschnitt** (mod. 4000.0)
- Testina di taglio larga e girevole
- Manico in ottone

RICAMBI

Testina larga di ricambio mod. 4010.0 - 1 PEZZO	Ref.	Barcode	Box	€
	50508	8001066505081	1	-



TAGLIAVETRO CIRCOLARE SILBERSCHNITT CON PIASTRA A VENTOSA

Ref.	L mm	Barcode	Box	€
50509	60	8001066505098	1	-

- Tagliavetro circolare con piastra a ventosa **originale Silberschnitt** (mod. 511.0)
- 6 rotelle di acciaio sulla rosetta
- Asta graduata ribaltabile per impostazione esatta della misura

RICAMBI

Rotella di ricambio mod. 102.1 - 12 PEZZI	Ref.	Barcode	Box	€
	50501	8001066505012	10	-

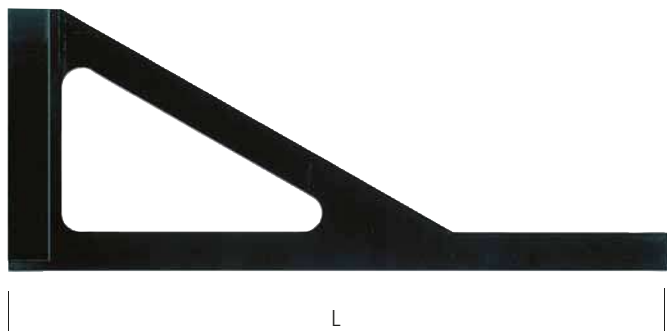

**SQUADRA PROFESSIONALE
PER VETRAI**

Ref.	L			€
50518	80 cm	8001066505180	1	-
50519	135 cm	8001066505197	1	-

- Squadra professionale per vetrai piana con braccio
- Materiale sintetico monoblocco molto resistente
- Alta precisione, non deformabile
- Sezione 54 x 4 mm

**RIGA SPECIALE
PER VETRAI**

Ref.	L cm	A x B mm			€
50530	100	50 x 4	8001066505302	1	-

- Riga speciale per vetrai
- Antigraffio in plastica flessibile
- Con impugnatura

**SQUADRA SPECIALE
PER VETRAI**

Ref.	A x B cm			€
50535	50 x 25	8001066505357	1	-

- Squadra speciale per vetrai
- Antigraffio in plastica flessibile
- Con impugnatura
- Sezione 40 x 4 mm



**GONIOMETRO SPECIALE
PER VETRAI**

Ref.	Ø cm			€
50540	33	8001066505401	1	-

- Goniometro speciale per vetrai
- Antigraffio in plastica flessibile
- Con impugnatura
- Sezione 40 x 4 mm

02

VENTOSE

Ref.	Kg		Ø mm			€
50541	40	1	120	8001066505418	1	-
50543	80	2	120	8001066505432	1	-
50545	160	3	120	8001066505456	1	-

- Ventosa con **impugnatura gommata**
- Portata kg 40 - 80 - 160
- Diametro 120 mm



Ref. 50541



Ref. 50543



Ref. 50545



**CESCOIA DOPPIA LEVA TAGLIO RETTILINEO
TAGLIO DESTRO/TAGLIO SINISTRO**

Ref.	A			€
68781	250	8001066687817	1	-
68782	250	8001066687824	1	-
68783	250	8001066687831	1	-

- German Type
- Materiale: 60Cr-V o Cr-Mo
- Durezza lame: 56-62 HRC
- Impugnatura antiscivolo PVC/TPR



Ref. **68781**

TAGLIO RETTILINEO



Ref. **68782**

TAGLIO DESTRO



Ref. **68783**

TAGLIO SINISTRO



A

FORBICI DA LAVORO NICHELATE

Ref.	A			€
69592	5½"	8001066695928	10	-
69593	6"	8001066695935	10	-
69594	6½"	8001066695942	10	-

- Lame in acciaio stampato a caldo
- Assemblate a mezzo vite



A

FORBICI PER SARTO

Ref.	A			€
69595	9"	8001066695959	5	-

- Lame in acciaio nichelato stampato a caldo
- Assemblate a mezzo vite
- Manico verniciato

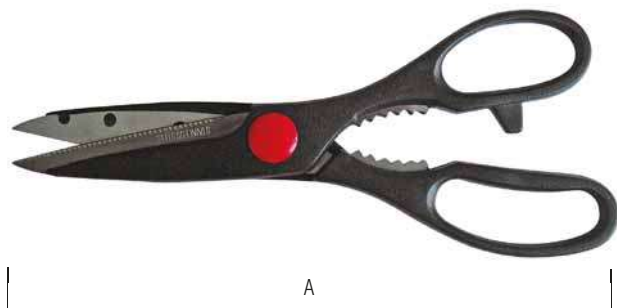

A

FORBICI INOX MULTIUSO

Ref.	A			€
72600	215 mm	8001066726004	10	-

- Lame in acciaio inox ricoperte
- Manico in ABS
- Uso per casa e ufficio (non per uso alimentare)



A

TAGLIACAMPIONI

Ref.	A			€
69601	8"	8001066696017	5	-

- Lame in acciaio nichelato stampato a caldo
- Assemblate a mezzo vite
- Manico in nylon

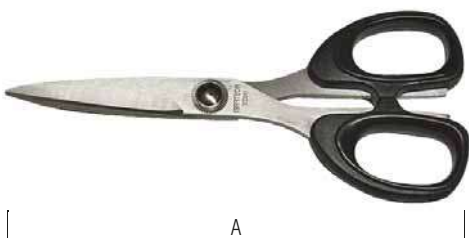

A

FORBICI DA LAVORO

Ref.	A			€
69598	165 mm	8001066695980	5	-

- Lame inox con durezza 52/54 HRC
- Manici in ABS antiurto



A

FORBICI ELETTRICISTA

Ref.	A			€
68775	145 mm	8001066687756	10	-

- Lama retta inox con spelafilo
- Durezza lame 52/54 HRC
- Lama con microdentatura antiscivolo
- Manici in nylon rinforzati con fibra di vetro
- Interno anelli in gomma TPR



A

FORBICI ELETTRICISTA

Ref.	A			€
68776	155 mm	8001066687763	10	-

- Lama retta inox senza spelafilo
- Durezza lame 52/54 HRC
- Lama con microdentatura antiscivolo
- Manici in nylon rinforzati con fibra di vetro, ampio anello per impugnatura a due dita
- Interno ed esterno anello in gomma TPR



A

FORBICI ELETTRICISTA

Ref.	A			€
68777	150 mm	8001066687770	10	-

- Lama retta inox con doppio profilo tagliente da 15 mm
- Durezza lame 56 HRC
- Lama con microdentatura antiscivolo
- Manici ergonomici in nylon rinforzati con fibra di vetro
- Anelli con doppio appiglio, per maggiore forza in fase di taglio, ed esterno in gomma TPR



A

FORBICI ELETTRICISTA

Ref.	A			€
68753	145 mm	8001066687534	10	-

- Lame in acciaio inox stampato a caldo
- Lame assemblate per mezzo di vite
- In bustina trasparente

02

CONTAFILO A LIBRO OTTONATI

Ref.	A x B mm				€
49562	10 x 10	12 X	8001066495627	2	-
49563	15 x 15	10 X	8001066495634	2	-
49564	20 x 20	6 X	8001066495641	2	-
49565	30 x 30	5 X	8001066495658	2	-

■ In metallo ottonato

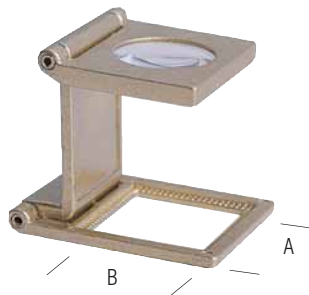

CONTAFILO A LIBRO IN METALLO NERO

Ref.	A x B mm				€
49581	20 x 20	8 X	8001066495818	2	-
49582	30 x 30	8 X	8001066495825	2	-

■ In metallo nero con graduazione



CONTAFILO A LIBRO IN PLASTICA

Ref.	A x B mm				€
49550	20 x 20	8 X	8001066495504	2	-

■ In plastica nera



LENTE TASCABILE

Ref.	Ø				€
49510	50 mm	3,5 X	8001066495108	1	-

■ Lente in cristallo ottico
 ■ Senza manico
 ■ Custodia incernierata in similpelle



LENTE D'INGRANDIMENTO CON LED



Ref.	Ø				€
49494	110 mm	2 X	8001066494941	2	-
49492	90 mm	2 X	8001066494927	2	-

■ Cristallo ottico con LED
 ■ Manico gommato



LENTE D'INGRANDIMENTO BIFOCAL



Ref.	Ø				€	Ref.			€
49498	75 mm	2,5 - 5 X	8001066494989	1	-	09498	8001066094981	10	-

■ Lente acrilica a doppio ingrandimento 2,5 x - 5 x
 ■ Manico tondo

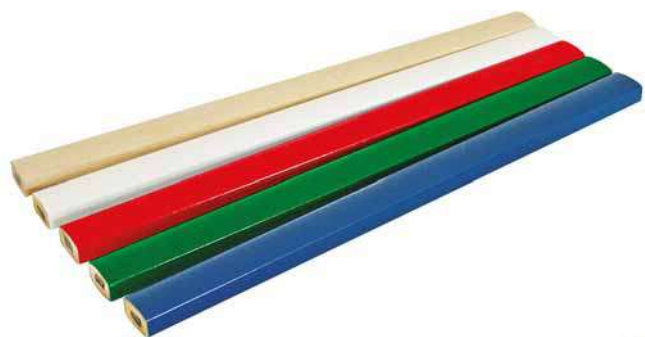

MATITE PER FALEGNAMMI
18 cm

Ref.	L				€
51050N	18 cm	●	8001066511501	1	–
51051N	18 cm	●	8001066511518	1	–
51052N	18 cm	●	8001066511525	1	–
51053N	18 cm	○	8001066511532	1	–
51054N	18 cm	●	8001066511549	1	–
49159			8001066491599	10	–

- Mina HB nera
- Confezione da 144 pezzi



Ref. **48159**

- Temperino per matita da falegname

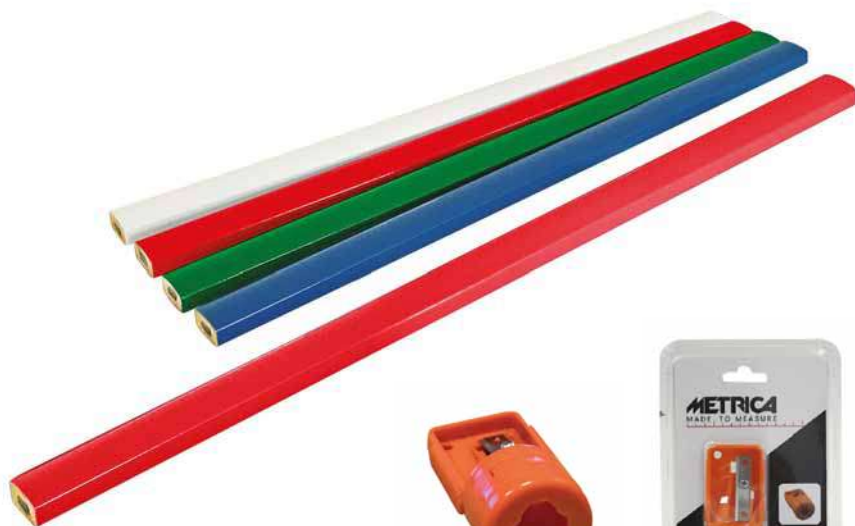

MATITE PER FALEGNAMMI
24 cm - 30 cm

Ref.	L				€
51010	24 cm	●	8001066510108	1	–
51011	24 cm	●	8001066510115	1	–
51012	24 cm	○	8001066510122	1	–
51013	24 cm	●	8001066510139	1	–
51020	30 cm	●	8001066510207	1	–
49159			8001066491599	10	–

- Mina HB nera
- Confezione da 144 pezzi



Ref. **48159**

- Temperino per matita da falegname



MATITE PER MARMISTI

Ref.	L				€
51060	24 cm	●	8001066510603	1	–
51070	30 cm	●	8001066510702	1	–
49159			8001066491599	10	–

- Mina dura nera
- Confezione da 144 pezzi



Ref. **48159**

- Temperino per matita da falegname

02

**CONFEZIONI APPENDIBILI
MATITE PER FALEGNAMMI**

6 PEZZI	Ref.			€
Matite 18 cm	51040	8001066510405	12	-
	51041	8001066510412	12	-
	51042	8001066510429	12	-

3 PEZZI	Ref.			€
Matite 30 cm	50390	8001066503902	6	-



**CONFEZIONI APPENDIBILI
MATITE PER MARMISTI**

3 PEZZI	Ref.			€
Matite 24 cm	50393	8001066503933	6	-

3 PEZZI	Ref.			€
Matite 30 cm	50392	8001066503926	6	-





**MATITONE A PULSANTE
PER USO INDUSTRIALE**

Ref.	L	Ø			€
01089	14 cm	5,5 mm	8001066010899	1	-

- Matita per uso industriale e edilizia
- **Corpo blu rubber touch**
- Pulsante
- Mina gigante nera 2B diam. 5,5 mm

MINE DI RICAMBIO	Ref.			€
Mina nera 90 mm 6 PEZZI	● 01090	8001066010905	1	-



**MATITONE A PULSANTE
PER USO INDUSTRIALE**

Ref.	L	Ø			€
51080	14 cm	5,5 mm	8001066510801	1	-

- Matita per uso industriale e edilizia
- **Corpo nero in bachelite**
- Pulsante metallico
- Mina gigante nera HB diam. 5,5 mm

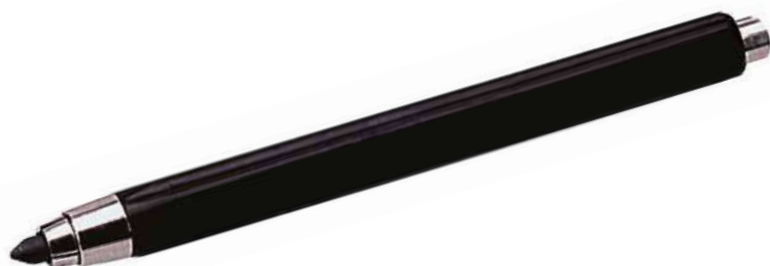

MINE DI RICAMBIO	Ref.			€
Mina nera 90 mm 6 PEZZI	● 01090	8001066010905	1	-



02



Metallo
Plastica
Pietra
Ceramica
Legno
Vetro



TRADES-MARKER®(*) DRY

Ref.	L	Ø			€
51083	16 cm	2,8 mm	8001066510832	1	-

- Marcatore in grafite
- Corpo e clip in metallo
- Tascabile
- Lunghezza punta 45 mm (per accessi difficili)
- Uscita mina a pulsante
- Mina diametro 2,8 mm
- **Scrive su qualsiasi superficie**
- Confezionata con 6 mine di ricambio (2 in grafite nera, 2 in cera rossa, 2 in cera gialla)

* marchio di proprietà del titolare

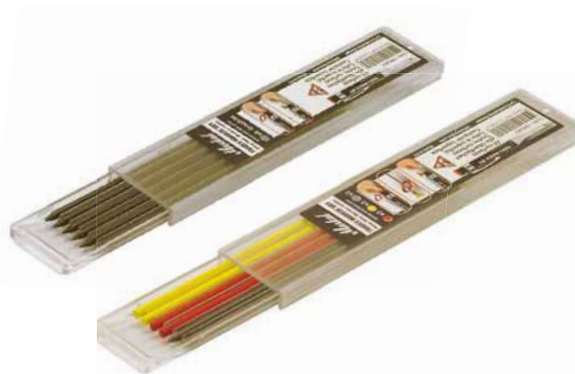

MINE DI RICAMBIO	Ref.			€
6 PEZZI 2 mine in grafite nera 2 mine in cera gialla 2 mine in cera rossa	● 51093	8001066510931	1	-
6 PEZZI Mine in grafite nera	● 51094	8001066510948	1	-

SCATOLA SELF SERVICE 20 PEZZI

Ref.		Pezzi per scatola	€
51098	8001066510986	20 + 10 + 10 pezzi	-



MATITA PER FALEGNAME CON MINA INTERCAMBIABILE

Ref.	L	Ø			€
51105	18 cm	2 mm	8001066511051	10	-

- Blocco scorrimento mina
- Portamine in ABS con **6 pezzi di ricambio** inclusi nella confezione
- Mine con sezione rettangolare di 2 mm
- **Temperino incorporato**



MATITA ALL SCRIPT 100% GRAFITE

Ref.	L			€
51150	16 cm	8001066511501	12	-
51151	16 cm	8001066511518	1	-

- Scrive su tutte le superfici
- 100% grafite
- Scrive 10 volte più di una matita tradizionale
- Punta sempre pronta, senza temperino
- Non sporca le mani
- Resiste agli urti e alle rotture, leggermente flessibile
- Ref. 51151: 2 pz in blister



Ref. 51151



Ref. 51150



YouTube

Ferro
Legno
Metallo
Carta
Cartone
Ceramica



PASTELLI INDUSTRIALI ESAGONALI





Ref.							€	Ref.			€
50040	12	-	-	-	8001066500406	1	-	-	-	-	-
50041	-	12	-	-	8001066500413	1	-	-	-	-	-
50042	-	-	12	-	8001066500420	1	-	-	-	-	-
50043	-	-	-	12	8001066500437	1	-	-	-	-	-
-	1	1	1	1	-	-	-	86015	8001066860159	10	-

- Pastelli esagonali
- Per scrivere **su ferro** freddo e caldo, metallo, legno, carta, cartone etc.
- Dimensioni 120 x Ø 12 mm

Ferro
Legno
Metallo
Carta
Cartone



GESSETTI DI STEATITE - Ø 5 mm





Ref.	A mm	B mm			€
50049	90 mm	5 mm	8001066500499	1	-

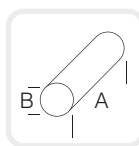

- Gessetti tascabili cilindrici
- Resistono al calore
- Per scrivere su acciaio e ferro
- Confezione da 50 pezzi



GESSETTI DI STEATITE



Ref.	A x B x C mm			€	Ref.			€
50045	100 x 10 x 10	8001066500451	1	-	00045	8001066000456	5	-

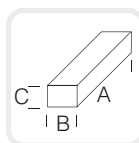

- Gessi quadrati, naturali
- Resistono al calore
- Per scrivere su **acciaio e ferro**
- Confezione da 12 pezzi



GESSETTI COMUNI

Ref.	A x B x C mm			€
50047	80 x 10 x 10	8001066500475	1	-



- **Gessetti comuni**
- Confezione da 100 pezzi

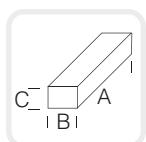



FOLLOW ME SPRAY

Ref.				€
50181		8001066501816	12	-
50182		8001066501823	12	-
50183		8001066501830	12	-
50184		8001066501847	12	-
50185		8001066501854	12	-
50186		8001066501861	12	-

- Marcatore spray da cantiere 500 ml
- Colori fluorescenti - non permanenti
- Senza piombo e senza CFC
- Per marcature nette su qualsiasi superficie anche umida (**cemento, asfalto, pietra, erba, sabbia**, etc.)
- Tappo blocca spruzzo di sicurezza
- **Valvola autopulente**
- Applicabilità fino a -20 °C
- **Lunga durata**
- Stabilità prolungata
- **Non pericoloso per la natura**

Cemento
Asfalto
Pietra
Erba
Sabbia
Superfici umide

**DURA NEL TEMPO
E SCRIVE PIÙ A LUNGO!**

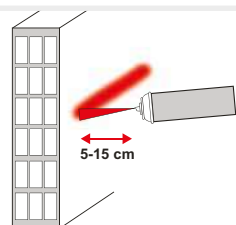

**SCRITTURA
VERTICALE**

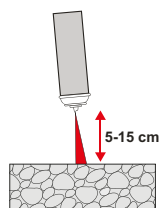

**SCRITTURA
ORIZZONTALE**

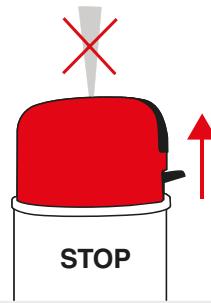

METRICA FOLLOW ME MARCATORI A VERNICE LIQUIDA

Ref.	●	●	○	●	📦	€
50140	24				8001066501403	1 -
50141		24			8001066501410	1 -
50142			24		8001066501427	1 -
50143				24	8001066501434	1 -
50148	6	6	6	6	8001066501489	1 -

- Marcatore a vernice indelebile
- Punta a sfera
- **Scrive su ogni materiale**
- Particolarmente adatto per **ferro, legno, gomma, cemento, marmo, vetro**
- Confezione da 24 pezzi



- | | |
|--------------|----------|
| Metallo | Legno |
| Gomma | Tessuti |
| Plastica | Tubi |
| Asfalto | Condotti |
| Pietra | Vetro |
| Calcestruzzo | |

QUIK STIK®(+)

Ref.	●	●	●	○	📦	€
50150M	12				8001066501502	1 -
50151M		12			8001066501519	1 -
50152M			12		8001066501526	1 -
50153M				12	8001066501533	1 -

- Marcatore a vernice solida in stick
- Asciugatura rapida 5/7 minuti
- Scrive su tutte le superfici: bagnate, lisce, ruvide o calde
- Tappo ermetico
- **Tratto** 17 mm
- Confezione da 12 pezzi

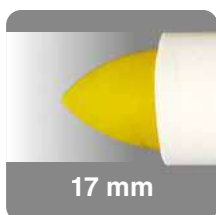

- | | |
|--------------|----------|
| Metallo | Vetro |
| Gomma | Ceramica |
| Plastica | Tubi |
| Legno | Condotti |
| Pietra | |
| Calcestruzzo | |

QUIK STIK®(+) MINI

Ref.	●	●	●	○	📦	€
50350M	12				8001066503506	1 -
50351M		12			8001066503513	1 -
50352M			12		8001066503520	1 -
50353M				12	8001066503537	1 -

- Marcatore a vernice solida in stick
- Asciugatura rapida 5/7 minuti
- Scrive su tutte le superfici: bagnate, lisce, ruvide o calde
- Tappo con clip
- **Tratto** 6 mm
- Confezione da 12 pezzi

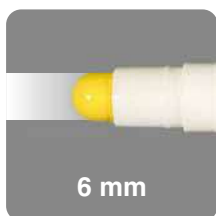

- | | |
|--------------|----------|
| Metallo | Vetro |
| Gomma | Ceramica |
| Plastica | Tubi |
| Legno | Condotti |
| Pietra | |
| Calcestruzzo | |

* marchio di proprietà del titolare

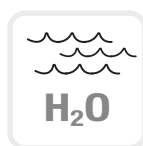

Metallo
Legno
Lingotti
Pietra
Calcestruzzo

PAINT STIK®(*)

Ref.	○	●	●	📦	€
50220M	12			8001066502202	1 -
50221M		12		8001066502219	1 -
50222M			12	8001066502226	1 -

- Vernice solida morbida in stick
- Asciugatura rapida 5/7 minuti
- Adatto a superfici ruvide o fredde
- Marcatura resistente a immersioni prolungate in acqua
- Resistente ad agenti atmosferici e raggi UV
- Rivestito in cartone riciclato
- **Tratto** 9,5 mm
- Confezione da 12 pezzi

DURA-INK® 55

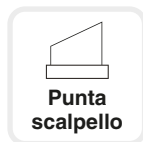

DURA-INK® 60

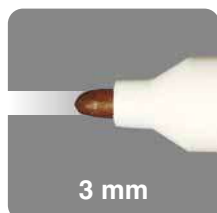

Metallo
Legno
Cartone
Pietra
Tubi
Lamiere
Condotte
Plastica
Vetro

DURA-INK®(*) 55 DURA-INK®(*) 60

Ref.	●	●	●	📦	€
50001M	12			8001066500017	1 -
50002M		12		8001066500024	1 -
50003M			12	8001066500031	1 -
50004M	12			8001066500048	1 -
50005M		12		8001066500055	1 -
50006M			12	8001066500062	1 -

- Inchiostro industriale ad asciugatura rapida, resistente all'acqua e ai graffi
- Solido serbatoio in plastica antirottura con tappo a clip
- Punta ultradurezza tonda o a scalpello
- Dura-ink® 60 **tratto** 3 mm
- Dura-ink® 55 **tratto** 1,5/4,5 mm
- Confezione da 12 pezzi

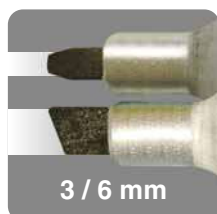

Metallo
Legno
Cartone
Pietra
Tubi
Lamiere
Condotte
Plastica
Vetro

DURA-INK®(*) 25

Ref.	●	●	📦	€
50007M	12		8001066500079	1 -
50009M		12	8001066500093	1 -

- Inchiostro industriale ad asciugatura rapida, resistente all'acqua e ai graffi
- Solido serbatoio in metallo con tappo a clip
- Punta a scalpello versatile consente di creare marcature fini o spesse
- **Tratto** 3/6 mm
- Confezione da 12 pezzi

* marchio di proprietà del titolare





Metallo
 Cartone
 Tubi
 Condotte
 Plastica
 Vetro

Legno
 Pietra
 Tessuti

DURA-INK®(*) 15

Ref.	●	●	●	📦	€
50100M	12			8001066501007	1 -
50101M		12		8001066501014	1 -
50102M			12	8001066501021	1 -

- Inchiostro industriale ad asciugatura rapida, resistente all'acqua e ai graffi
- Solido serbatoio in plastica antirottura con tappo a clip
- Punta ultradura evita qualsiasi sbavatura
- **Tratto** 1,5 mm
- Confezione da 12 pezzi



Metallo
 Cartone
 Tubi
 Condotte
 Plastica
 Vetro

Legno
 Pietra
 Tessuti

DURA-INK®(*) 5

Ref.	●	📦	€
50018M	12	8001066500185	1 -

- Inchiostro industriale ad asciugatura rapida, resistente all'acqua e ai graffi
- Solido serbatoio in plastica antirottura e punta in metallo, tappo a clip
- Micropunta estesa ideale per marcare attraverso fori e aree difficili da raggiungere
- **Tratto** 1 mm
- Confezione da 12 pezzi



TRATTO MARKER®(*) AD ALCOOL

Ref.	●	●	●	●	📦	€
50011	20				8001066500116	1 -
50012		20			8001066500123	1 -
50013			20		8001066500130	1 -
50014				20	8001066500147	1 -

- Tratto marker **originali Fila**
- Inchiostro permanente **a base d'alcool per tutte le superfici**
- Corpo in plastica
- Punta a scalpello
- Confezione da 20 pezzi

* marchio di proprietà del titolare



PASTELLI STRADALI

Ref.	A x B mm				€
50070	140 x 20		8001066500703	12	-
50071	140 x 20		8001066500710	12	-
50072	140 x 20		8001066500727	12	-

- Alta qualità
- **Pastello ad olio**
- Indelebile, resistente all'acqua, **scrive sul bagnato**



GESSI STRADALI GIGANTI

Ref.	A x B x C mm				€
50050	200 x 50 x 30		8001066500505	1	-
50051	200 x 50 x 30		8001066500512	1	-

- Gesso ad olio
- **Resistente all'acqua**

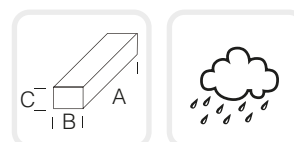

NASTRO STRADALE

Ref.	L	A			€
60120	200 m	70 mm	8001066601202	6	-
60122	100 m	70 mm	8001066601226	1	-
60132	100 m	50 mm	8001066601325	1	-

- Nastro stradale
- In polietilene bianco/rosso

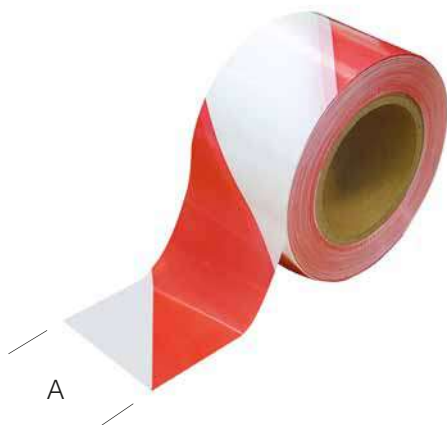

FILO A PIOMBO - TIPO CILINDRICO



Ref.	gr			€
60350	100	8001066603503	5	-
60352	200	8001066603527	5	-
60353	300	8001066603534	5	-
60354	400	8001066603541	5	-
60355	500	8001066603558	5	-

- Filo a piombo tipo cilindrico
- Verniciato a polvere
- Vite in ottone
- Include filo da 5 m e piastrina

FILO A PIOMBO - TIPO CONICO



Ref.	gr			€
60363	300	8001066603633	5	-
60364	400	8001066603640	5	-

- Filo a piombo tipo conico
- Verniciato a polvere
- Vite in ottone
- Include filo da 5 m e piastrina

FILO DA MURATORE



Ref.	m			€	
60201	25	○	8001066602018	10	-
60202	500	○	8001066602025	1	-
60205	50	●	8001066602056	1	-

- Cod. **60201** e **60202**: filo da muratore bianco, materiale sintetico
- Cod. **60205**: filo da muratore verde, nylon



CORDA A RULLO

Ref.	L	Ø			€
60390	50 m	1,5 mm	8001066603909	5	–

- Bobina girevole
- Supporto con dispositivo di bloccaggio
- Corda in polipropilene gialla



CORDA A MANO

Ref.	L	Ø			€
60391	50 m	1,5 mm	8001066603916	1	–

- Impugnatura ergonomica con bloccaggio
- Supporto con dispositivo di bloccaggio
- Corda intrecciata in polipropilene gialla



COLORANTI SINTETICI PER USO INTERNO/ESTERNO

Ref.					€
60190	1000		8001066601905	1	–
60191	1000		8001066601912	1	–
60192	750		8001066601929	1	–
60193	750		8001066601936	1	–
60194	500		8001066601943	1	–
60195	500		8001066601950	1	–
60196	1000		8001066601967	1	–
60197	1000		8001066601974	1	–
60198	750		8001066601981	1	–

- Colorante sintetico per uso interno e esterno
- Ideale per solette in cemento, pavimenti, camini, graniti, mosaici, rivestimenti, intonaci



COLORANTI NATURALI

Ref.					€
60220	1		8001066602209	1	–
60221	1		8001066602216	1	–
60222	1		8001066602223	1	–
60223	1		8001066602230	1	–

- Colorante naturale per uso interno e esterno
- Inalterabile ai raggi UV
- Ideale per calcestruzzo, camini, intonaci di calce



TRACCIATORE CASSA ABS

Ref.	L mm	Barcode	Icon	€
60110	25	8001066601103	6	-

- Tracciatore ricaricabile
- Include 25 m di cordoncino per tracciatura Ø 2 mm
- Include 150 g di polvere blu
- Cassa in ABS ergonomica
- Filo cotone Ø 2 mm
- In blister

RICAMBI	Ref.	Barcode	Icon	€
150 g polvere	● 60112	8001066601127	12	-
	● 60101	8001066601011	1	-
50 m cordoncino	60114	8001066601141	1	-



TRACCIATORE CASSA ABS AD INNESTO

Ref.	L mm	Barcode	Icon	€
60095	30	8001066600953	1	-

- Tracciatore ricaricabile
- Include 30 m di cordoncino e 100 g di polvere blu
- Cassa in ABS ergonomica con innesto flacone ad uso impugnatura
- Capacità complessiva 200 g
- In blister

RICAMBI	Ref.	Barcode	Icon	€
100 g polvere	● 60096	8001066600960	12	-



TRACCIATORE CASSA ALLUMINIO AD INNESTO

Ref.	L mm	Barcode	Icon	€
60126	30	8001066601264	1	-

- Tracciatore ricaricabile
- Include 30 m di cordoncino e 100 g di polvere blu
- Cassa in alluminio pressofuso con innesto flacone ad uso impugnatura
- Capacità complessiva 150 g
- In blister

RICAMBI	Ref.	Barcode	Icon	€
100 g polvere	● 60123	8001066601233	1	-



TRACCIATORE GIGANTE CASSA ABS

Ref.	L	Barcode	Box	€
60097	50 m	8001066600977	6	-

- Tracciatore ricaricabile professionale per strade e cantieri
- Include 50 m di cordone Ø 3 mm ad alta resistenza (55 kg)
- Cassa in ABS ergonomica con impugnatura
- Manovella in acciaio
- Capacità complessiva 400 g

RICAMBI	Ref.	Barcode	Box	€
50 m cordone senza manovella	69098	8001066690985	10	-
50 m cordone con manovella	69097	8001066690978	1	-

POLVERI PER TRACCIATURA



Ref.	gr	Color	Barcode	Box	€
60113	400	Red	8001066601134	1	-
60133	400	Blue	8001066601332	1	-
60127	1000	Red	8001066601271	1	-
60128	1000	Blue	8001066601288	1	-
60140	3500	Red	8001066601400	1	-
60141	3500	Blue	8001066601417	1	-

- Colore intenso
- Marcatura **resistente ai raggi UV**
- Buona aderenza
- Confezione da 400 g, 1000 g e 3500 g.

FLUOMARK(*)



Ref.	gr	Color	Barcode	Box	€
60138	200	Orange	8001066601387	1	-
60139	200	Green	8001066601394	1	-

- Alta visibilità
- **Colori fluorescenti**
- Buona aderenza
- Confezione da 200 g

* marchio di proprietà del titolare

PORTATRAPANO

Ref.				€
68130	-	8001066681303	10	-

■ In cuoio



CINTURA

Ref.	L			€
69638	125 cm	8001066696383	5	-

■ Cintura in cuoio



PORTA ATTREZZI IN NYLON

Ref.	A x B			€
68132	24 x 11 cm	8001066681327	5	-

■ In nylon



BORSA PER CARPENTIERI IN NYLON

Ref.	A x B			€
68135	22 x 22 cm	8001066681358	5	-

■ In nylon
■ 1 tasca



PORTA ATTREZZI IN NYLON

Ref.	A x B			€
68137	28 x 26 cm	8001066681372	5	-

■ In nylon
■ 2 Tasche



TENAGLIA PER CEMENTISTA

Ref.	L			€
69180	220 mm	8001066691807	10	-
69181	250 mm	8001066691814	10	-

■ Manico rivestito in PVC



TAGLIABULLONI

Ref.	L			€
69160	350 mm	0800106691603	6	-
69170		0800106691702	6	-



Ref. 69170

PISTOLA PER SILICONE

Ref.				€
68250	-	8001066682508	12	-



■ Cartucce 300 ml Ø 50 mm
■ Impugnatura in alluminio
■ Barra spinta zincata

PISTOLA PER SILICONE PROFESSIONALE

Ref.				€
68255	-	8001066682553	12	-



■ Cartucce 300 ml Ø 50 mm
■ Impugnatura in fusione di alluminio
■ Corpo in alluminio

POSSIBILITÀ DI MISURA:

CALIBRO TRADIZIONALE
CALIBRO 4 FUNZIONI DI MISURA

A + B + C
A + B + C + D

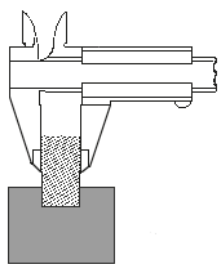

A
misure esterne

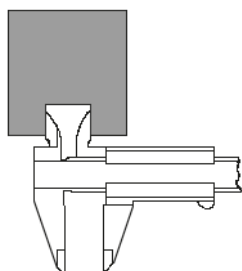

B
misure esterne

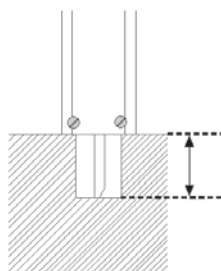

C
misure di profondità

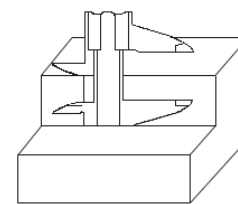

D
misure di spallamenti

NONIO:

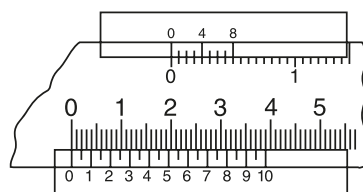

1/20 mm (0,05 mm + 1/128")

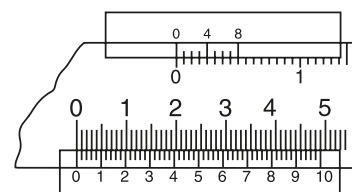

1/50 mm (0,02 mm + 1/128")

TOLLERANZE DIN 862

Lunghezza in mm	Tolleranza ± mm
0 ÷ 200	± 0,04
200 ÷ 300	± 0,05
300 ÷ 400	± 0,07
400 ÷ 500	± 0,08
500 ÷ 600	± 0,09
600 ÷ 700	± 0,10
700 ÷ 800	± 0,11
800 ÷ 900	± 0,12
900 ÷ 1000	± 0,13
1000 ÷ 1100	± 0,14

TOLLERANZE DIN 875

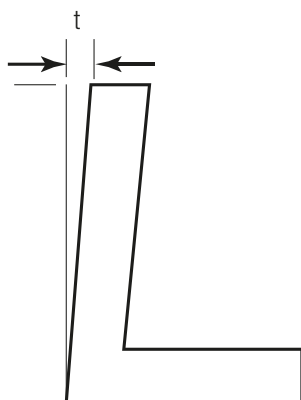

L	t = ± mm			
	00	0	1	2
50	0,003	-	-	-
75	0,003	0,007	0,014	0,028
100	0,003	0,007	0,015	0,030
150	0,004	0,008	0,018	0,035
200	0,004	0,009	0,020	0,040
250	0,005	0,010	0,023	0,045
300	0,005	0,011	0,025	0,050
500	0,007	0,015	0,035	0,070

CALIBRO AD ALTA VISIBILITÀ

Ref.	A mm	B mm	mm	inch			€
10080	0-150	40	0,01	0,0005	8001066100804	1	-



- **Modello professionale**
- Calibro in acciaio inox temprato
- 4 possibilità di misura
- **Schermo LCD ad alta visibilità - numeri giganti**
- Funzione ABS
- Autostop
- Risoluzione 0,01 mm/0,0005"
- Ripetibilità 0,01 mm/0,0005"
- Precisione 0,02 mm/0,001"
- Temperatura di esercizio 0 °C a 40 °C
- Pulsanti: ON/OFF, zero, ABS, mm/inch
- Uscita dati jack std a 4 vie 2,5 mm

Non vendibile in DE / UK / USA / JAP

CALIBRO DIGITALE IP 65

Ref.	A mm	B mm	mm	inch			€
10001	0-150	40	0,01	0,0005	8001066100019	1	-



- Protezione IP 65
- Impermeabili all'acqua, olio, polvere, particelle di metallo
- In acciaio inox temprato
- Lettura: 0,01 mm
- Precisione: ± 0,02 mm
- Ripetibilità: ± 0,01 mm
- 4 funzioni di misura
- 3 tasti: ON/OFF, zero, mm/inch

CALIBRO DIGITALE IP 67

Ref.	A mm	B mm	mm	inch			€
10018	0-150	40	0,01	0,0005	8001066100187	1	-



- Calibro in acciaio inox temprato
- Modello professionale
- Protezione IP 67
- Impermeabili all'acqua, olio, polvere, particelle di metallo
- 4 funzioni di misura
- Schermo LCD ad alta visibilità
- Realizzato secondo DIN 862
- Pulsanti: ON/OFF, zero, mm/inch
- Lettura: 0,01 mm
- Precisione: ± 0,02 mm
- Ripetibilità: ± 0,01 mm

CALIBRO DIGITALE IP 54 OUTPUT DATA

Ref.	A mm	B mm	mm	inch			€
10081	0-150	40	0,01	0,0005	8001066100811	1	-

- **Predisposto per trasmissione dati wireless**
- Calibro in acciaio inox temprato
- Modello professionale
- **Protezione IP54**
- 4 funzioni di misura
- **Schermo LCD ad alta visibilità**
- DIN862
- Pulsanti: ON/OFF, Zero, ABS, mm/inch
- Risoluzione 0,01 mm
- Ripetibilità 0,01 mm
- Precisione 0,01 mm
- Uscita dati

Non vendibile in DE / UK / USA / JAP

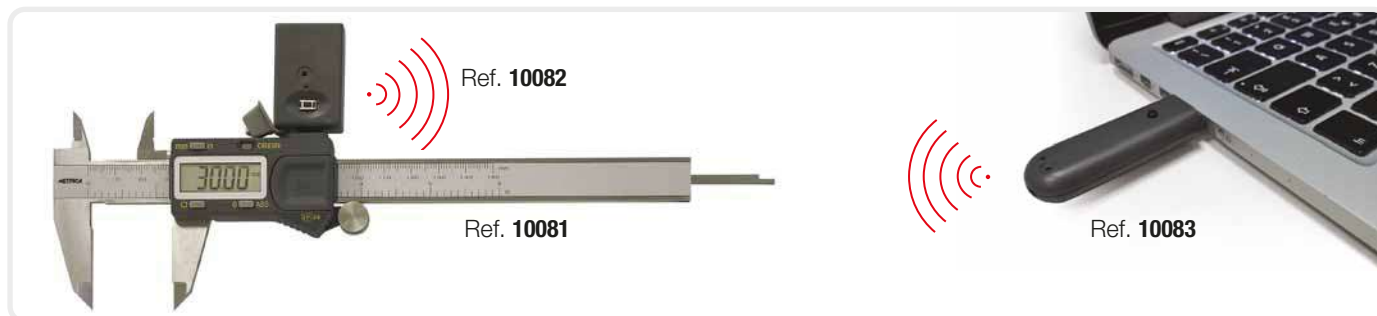

KIT TRANSFER DATA PER CALIBRO DIGITALE REF. 10081

Ref.				€
10082	20 m	8001066100820	1	-
10083	20 m	8001066100835	1	-



Trasmettitore dati wireless Ref. 10082 per trasmissione dati al Personal Computer

- Connettibile al calibro Ref. 10081
- Utilizzabile con ricevitore per PC Ref. 10083
- Frequenza di funzionamento:
2400 / 2483.5 MHz
- Distanza di funzionamento 20 m

Ricevitore dati wireless Ref. 10083 per trasmissione dati al Personal Computer

- Utilizzabile con trasmettitore Ref. 10082
- **Può gestire contemporaneamente 8 dispositivi Ref. 10082**
- Frequenza di funzionamento:
2400 / 2483.5 MHz
- Distanza di funzionamento 20 m

CALIBRO DIGITALE NUMERI GIGANTI (11 mm)

Ref.	A mm	B mm	mm	inch			€
10017	0-150	40	0,01	0,0005	8001066100170	1	-



- Acciaio inox temprato
- Display con numeri giganti (11 mm)
- 4 funzioni di misura
- 3 tasti:
 - accensione/spegnimento manuale
 - azzeramento per misure comparative ±
 - conversione mm/inch
- Precisione 0,02 mm
- Ripetibilità 0,01 mm



CALIBRO DIGITALE NUMERI GIGANTI (11 mm)

Ref.	A mm	B mm	mm	inch			€	Ref.			€
10002	0-155	40	0,01	0,0005	8001066100026	1	-	00002	8001066000029	1	-
10008	0-200	40	0,01	0,0005	8001066100088	1	-	-	-	-	-
10009	0-300	50	0,01	0,0005	8001066100095	1	-	-	-	-	-



- Acciaio inox temprato
- Display con numeri giganti (11 mm)
- 4 funzioni di misura
- 3 tasti:
 - accensione/spegnimento manuale
 - azzeramento per misure comparative ±
 - conversione mm/inch
- Precisione 0,02 mm
- Ripetibilità 0,01 mm



CALIBRO DIGITALE IN FIBRA DI CARBONIO

Ref.	A mm	B mm	mm	inch			€
10745	0-150	40	0,1	—	8001066107452	5	—

- Calibro digitale in fibra di carbonio
- Numeri giganti
- Capacità 150 x 0,1 mm
- Fornito in blister

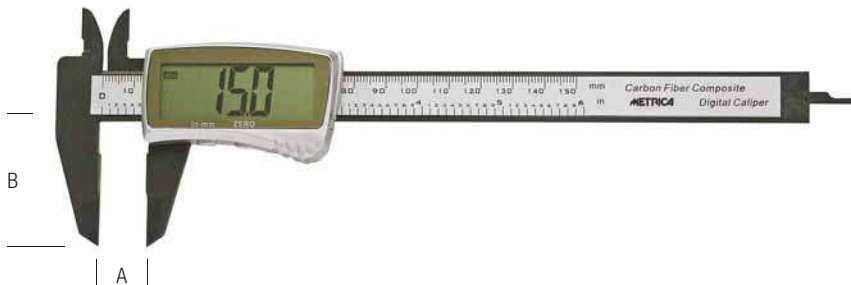

CALIBRO DIGITALE DI PROFONDITÀ

Ref.	A mm	B mm	mm	inch			€
12145	0-200	100	0,01	0,0005	8001066121458	1	—

- Acciaio inox temprato
- 3 tasti:
 - accensione manuale / spegnimento automatico
 - azzeramento per misure comparative ±
 - conversione mm/inch
- Ripetibilità 0,01 mm
- Astuccio in ABS
- Precisione ± 0,02 mm





CALIBRO ELETTRONICO DIGITALE

Ref.	A mm	B mm	mm	inch			€
12110	0-300	60	0,01	0,0005	8001066121106	1	—
12111	0-500	100	0,01	0,0005	8001066121113	1	—
12113	0-1000	120	0,01	0,0005	8001066121137	1	—

- Acciaio inox temprato
- Vite micrometrica di regolazione fine
- Display digitale:
 - accensione / spegnimento manuale
 - azzeramento per misure comparative ±
 - conversione mm/inch
- Ripetibilità 0,01 mm
- Astuccio in legno





CALIBRO MONOBLOCCO DI PRECISIONE

Ref.	A mm	B mm	mm	inch			€
10074	0-150	40	0,05	1/128	8001066100743	1	-

- DIN 862
- Acciaio inox temprato
- Corsoio monoblocco
- Bloccaggio a vite
- 4 funzioni di misura
- Scala cromata opaca
- Tabella filettatura sul retro
- Astuccio in ABS



CALIBRE DE ALTA CALIDAD

Ref.	A mm	B mm	mm	inch			€
10061	0-150	40	0,05	1/128	8001066100613	1	-

- DIN 862
- Acciaio inox temprato
- Corsoio monoblocco
- Bloccaggio a vite
- 4 funzioni di misura
- Scala graduata opaca
- In astuccio in similpelle

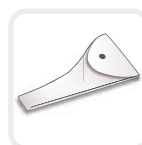

CALIBRO MONOBLOCCO DI PRECISIONE

Ref.	A mm	B mm	mm	inch			€
10051	0-160	47	0,05	1/128	8001066100514	1	-

- Acciaio inox temprato
- Corsoio monoblocco
- **Becchi lunghi (47 mm)** per misure di diametri fino a 94 mm
- **Esclusivo sistema di bloccaggio a leva che mantiene i becchi sempre perfettamente paralleli**
- 4 funzioni di misura
- Scala cromata opaca
- Tabella filettatura sul retro
- Astuccio in similpelle

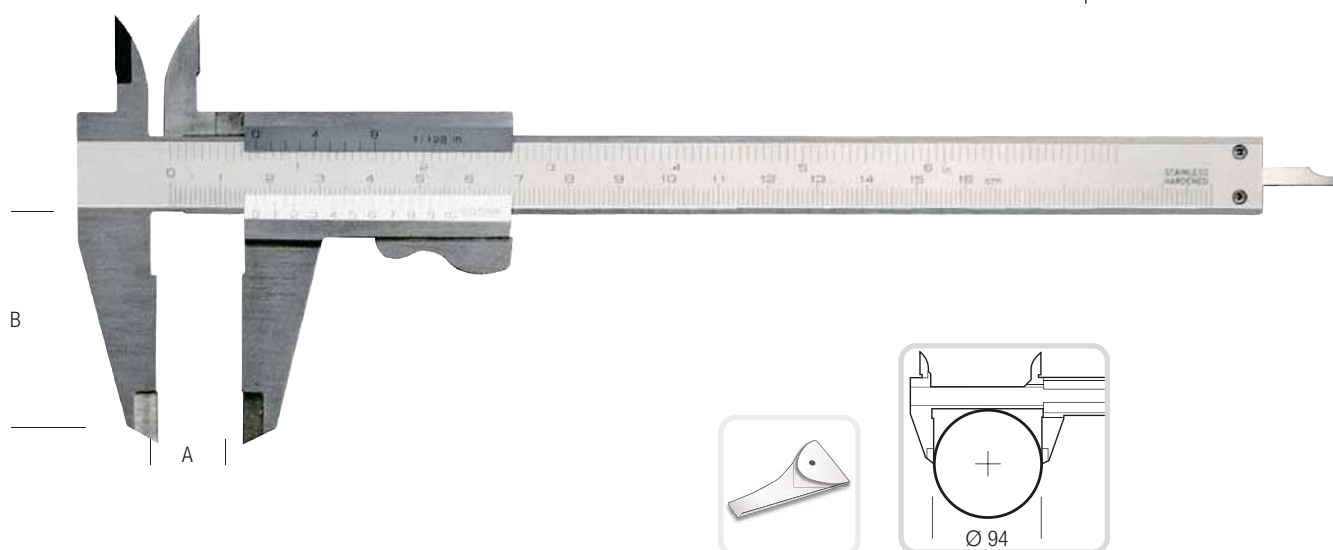

CALIBRO MONOBLOCCO

Ref.	A mm	B mm	mm	inch			€
10072	0-150	40	0,05	1/128	8001066100729	1	-

- Acciaio inox temprato
- Monoblocco
- 4 funzioni di misura
- Bloccaggio a leva
- Scala graduata opaca
- Astuccio in ABS

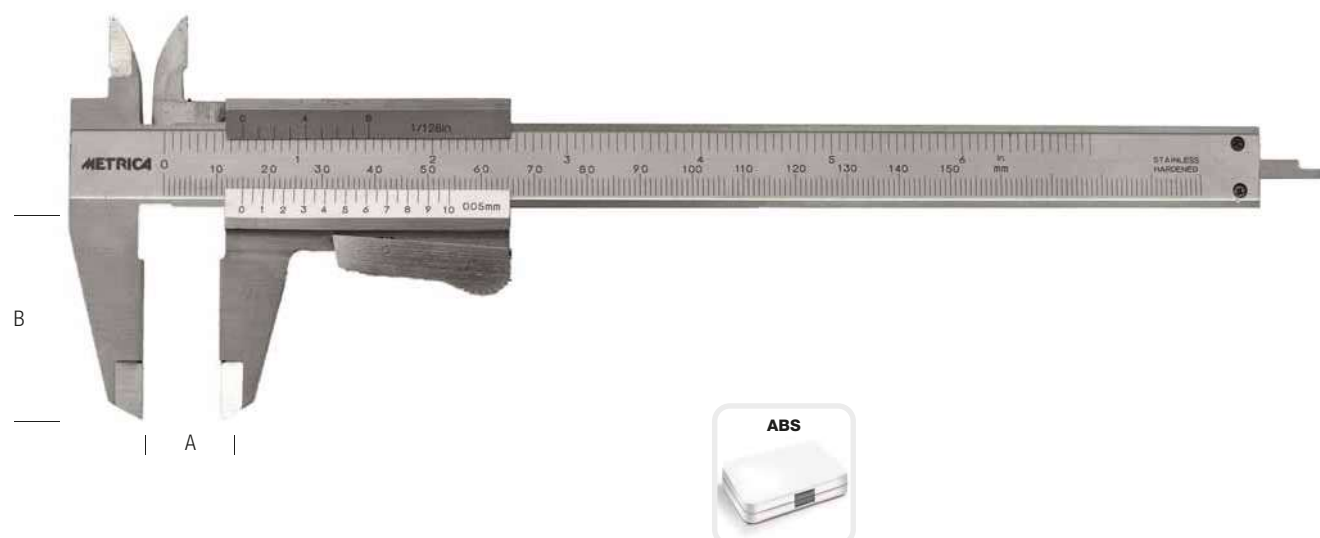

CALIBRO MONOBLOCCO SENZA PARALLASSE

Ref.	A mm	B mm	mm	inch			€
10013	0-150	40	0,02	1/128	8001066100132	1	-

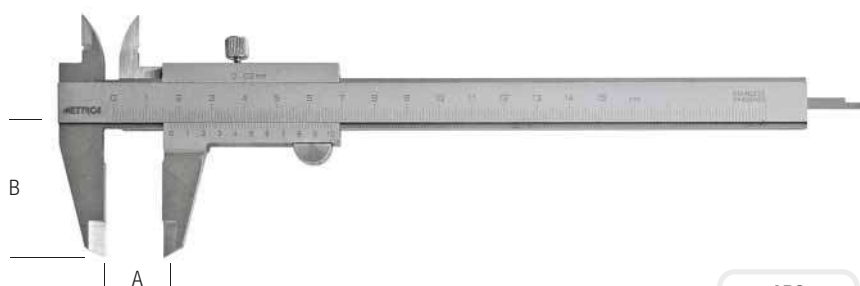

- Acciaio inox temprato
- Corsoio monoblocco
- Lettura senza parallasse, nonio e graduazione sullo stesso piano
- Bloccaggio a vite
- 4 funzioni di misura
- Scala cromata opaca
- Astuccio in ABS

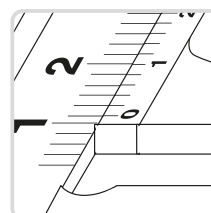

CALIBRO MONOBLOCCO DI PRECISIONE

Ref.	A mm	B mm	mm	inch			€
10058	0-200	45	0,02	-	8001066100583	1	-
10059	0-200	45	0,02	-	8001066100590	1	-

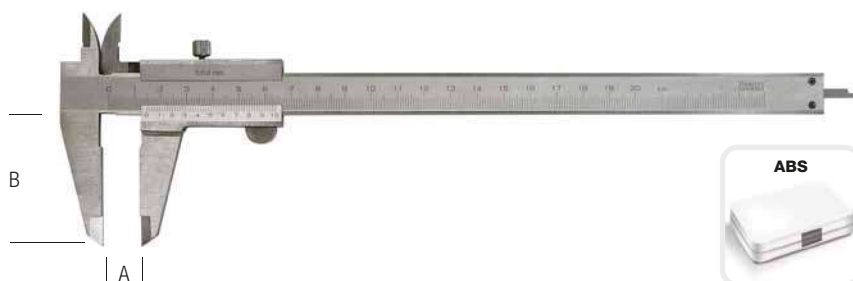

- Acciaio inox temprato
- Corsoio monoblocco
- Becchi lunghi (45 mm) per misure di diametri fino a 90 mm
- Sistema di bloccaggio a vite
- 4 funzioni di misura
- Scala cromata opaca
- Astuccio in ABS



Ref. **10059** fornito con righetta inox 200 mm

CALIBRO A QUADRANTE

Ref.	A mm	B mm	mm	inch			€
10023	0-150	40	0,01	-	8001066100231	1	-
10024	0-200	50	0,02	-	8001066100248	1	-

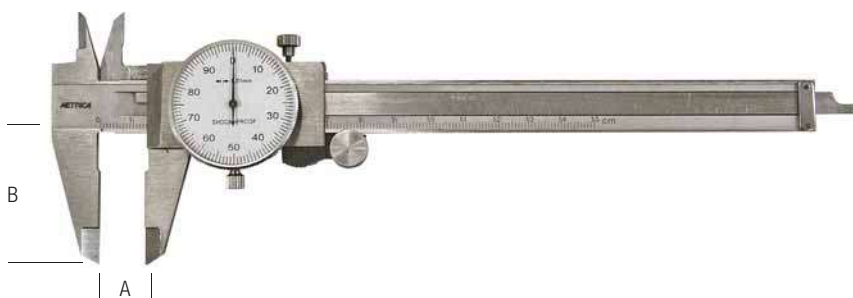

- Acciaio inox temprato
- 4 funzioni di misura
- Cremagliera protetta
- Quadrante azzerabile in ogni posizione
- Bloccaggio a vite

Ref. **10023**: 1 giro = 1 mm, lettura **0,01 mm**

Ref. **10024**: 1 giro = 2 mm, lettura 0,02 mm



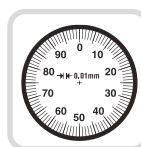

Ref. **10023**



Ref. **10024**





CALIBRO MONOBLOCCO

Ref.	A mm	B mm	mm	inch			€
10037	0-155	40	0,05	1/128	8001066100378	5	-

- Acciaio inox temprato
- Corsoio monoblocco
- Sistema di bloccaggio a leva
- 4 funzioni di misura
- Astuccio in ABS





CALIBRO DI PRECISIONE

Ref.	A mm	B mm	mm	inch			€
10055	0-155	40	0,02	-	8001066100552	1	-

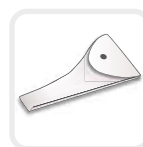
- **Acciaio inox temprato**
- Scala cromata opaca
- Rotella di trascinamento del corsoio
- Sistema di bloccaggio a vite
- 4 funzioni di misura
- Astuccio in similpelle





CALIBRO PER SALDATORI

Ref.	A mm	B mm	mm	inch			€
10480	0-20	40	0,1	-	8001066104802	1	-

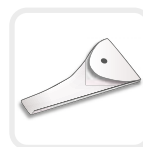
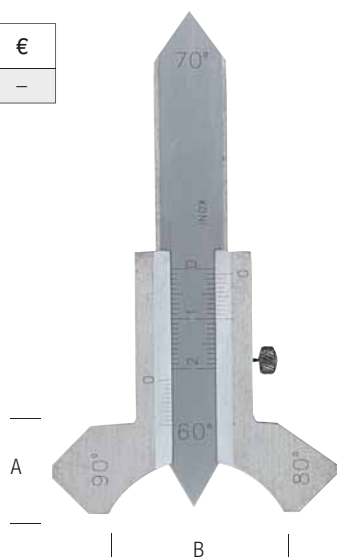
- Calibro per spessori saldatura
- Acciaio inox
- Scala cromata opaca
- Angoli 60°, 70°, 80°, 90°
- Astuccio in similpelle



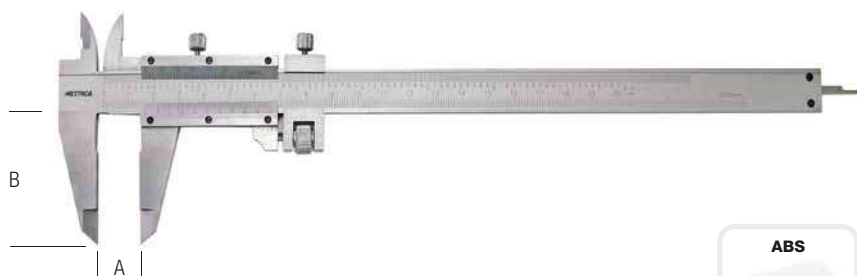

CALIBRO CON VITE DI PRECISIONE

Ref.	A mm	B mm	mm	inch			€
10067	0-200	45	0,02	1/1000	8001066100675	1	-



- Acciaio cromato - 200 x 0,02 mm
- Scala cromata opaca
- Bloccaggio a vite
- 4 funzioni di misura
- Regolazione fine
- Astuccio in ABS

CALIBRO DA OFFICINA

Ref.	A mm	B mm	mm	inch			€
10075	0-150	40	0,02	1/1000	8001066100750	1	-



- Acciaio cromato - 150 x 0,02 mm
- Scala cromata opaca
- Bloccaggio a vite
- 4 funzioni di misura
- Astuccio in ABS

BASE DI SUPPORTO PER CALIBRI

Ref.	A mm			€
10105	76	8001066101054	1	-

- Base di supporto per calibri a corsoio
- Per misure di profondità mediante l'astina del calibro

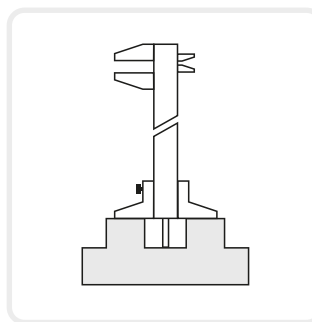
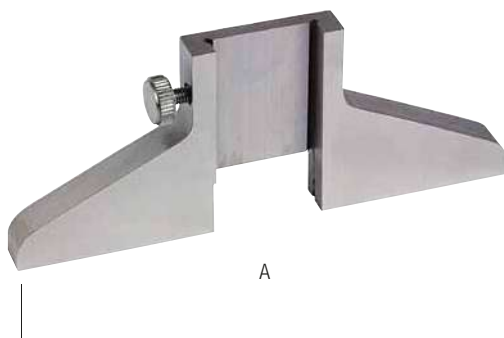

CALIBRO DA OFFICINA

Ref.	A mm	B mm	mm	inch			€	Ref.			€
10039	0-155	40	0,05	1/128	8001066100392	5	-	00039	8001066000395	5	-

- Acciaio inox temprato
- Scala cromata opaca
- Bloccaggio a leva
- 4 funzioni di misura
- Astuccio in ABS



CALIBRO TIPO SCUOLA

Ref.	A mm	B mm	mm	inch			€	Ref.			€
10038	0-150	40	0,05	1/128	8001066100385	5	-	00038	8001066000388	5	-
10031	0-200	40	0,05	1/128	8001066100316	1	-	-	-	-	-

- Acciaio inox temprato
- Scala cromata opaca
- Bloccaggio a leva
- 4 funzioni di misura
- Astuccio in similpelle



CALIBRO DA OFFICINA

Ref.	A mm	B mm	mm	inch			€
10064	0-155	40	0,05	1/128	8001066100644	5	-

- Acciaio inox temprato
- Scala cromata opaca
- Bloccaggio a vite
- 4 funzioni di misura
- Astuccio in ABS

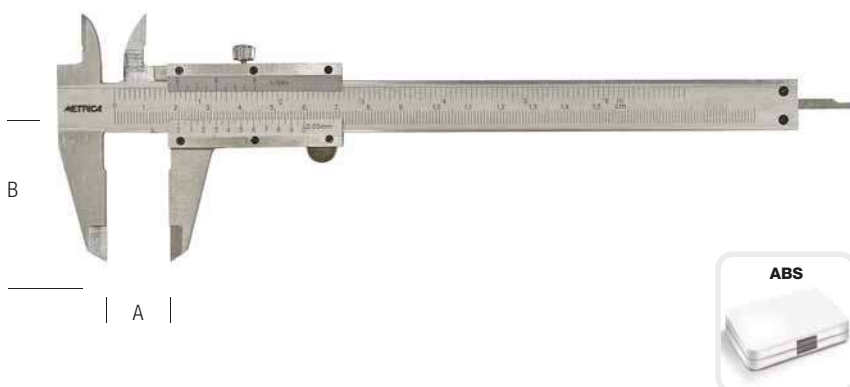

CALIBRO PER INGRANAGGI

Ref.	A mm	mm	inch			€
10181	mod. 1 ÷ 18	0,02	—	8001066101818	1	—

- Acciaio inox temprato
- Due corsei con vite micrometrica
- Astuccio in legno

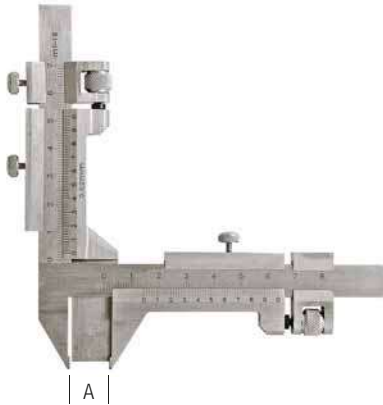

CALIBRO DI PROFONDITÀ

Ref.	A mm	B mm	mm	inch			€
10151	0-200	100	0,02	—	8001066101511	1	—
10153	0-300	100	0,02	—	8001066101535	1	—

- Acciaio inox temprato
- Scala cromata opaca
- Sistema di bloccaggio a vite
- Astuccio in legno



CALIBRO IN ABS

Ref.	A mm	B mm	mm	inch			€	Ref.			€
10722	0-150	40	0,10	—	8001066107226	10	—	00722	8001066007226	10	—
10723	0-150	40	0,10	—	8001066107230	10	—	—	—	—	—

- **Calibro in ABS**
- Senza parallasse, nonio e graduazione sullo stesso piano



Ref. **10722**

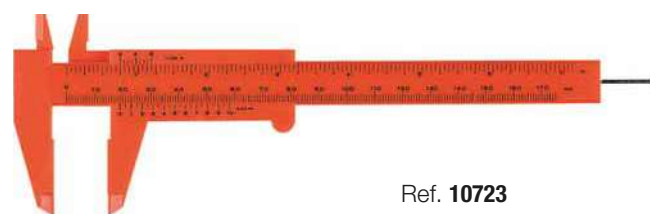

Ref. **10723**

MINI CALIBRO TASCABILE

Ref.	A mm	B mm	mm	inch			€	Ref.			€
10011	0-97	30	0,05	—	8001066100118	5	—	00011	8001066000111	5	—

- Tascabile
- Acciaio inox temprato
- Scala cromata opaca
- Bloccaggio a vite
- Astuccio in similpelle

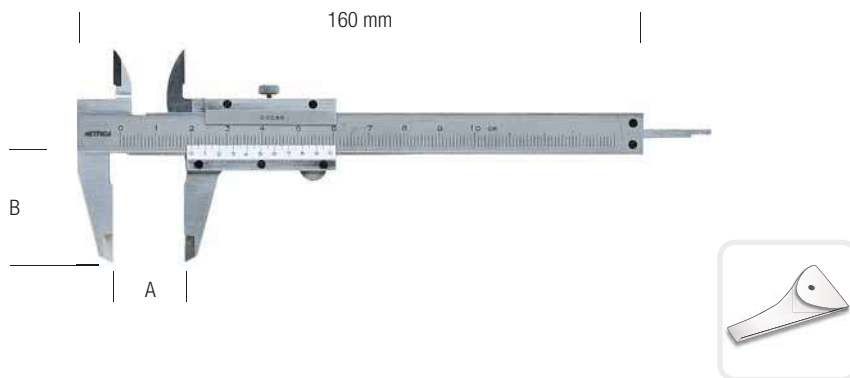

CALIBRO PER BOTTONI

Ref.	A mm	B mm	mm	inch			€	Ref.			€
10801	0-95	20	1	—	8001066108015	5	—	00801	8001066008018	10	—

- **Calibro speciale per bottoni (English)**
- In ottone
- Scala in mm



CALIBRO TASCABILE

Ref.	A mm	B mm	mm	inch			€
10700	0-120	35	0,10	1/16	8001066107001	5	—
10701	0-150	35	0,10	1/16	8001066107018	5	—

- Calibro tascabile in acciaio
- Bloccaggio a vite
- Rotella di trascinamento

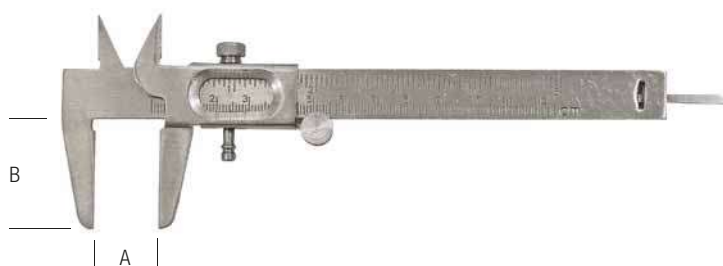

CALIBRO DI PRECISIONE

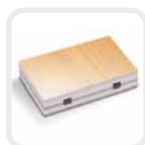

Ref.	A mm	B mm	mm	inch			€
11020	0-200	80	0,02	1/64	8001066110209	1	-
11021	0-250	80	0,02	1/64	8001066110216	1	-
11022	0-300	100	0,02	1/64	8001066110223	1	-
12040	0-500	150	0,02	1/128	8001066120406	1	-
12041	0-600	115	0,02	1/128	8001066120413	1	-
12043	0-800	150	0,02	1/128	8001066120437	1	-
12044	0-1000	150	0,02	1/128	8001066120444	1	-
12045	0-1200	150	0,02	1/128	8001066120451	1	-
12046	0-1500	150	0,02	1/128	8001066120468	1	-
12047	0-2000	300	0,02	1/128	8001066120475	1	-
12048	0-2500	300	0,02	1/128	8001066120482	1	-
12049	0-3000	300	0,02	1/128	8001066120499	1	-

- Acciaio inox temprato
- Vite micrometrica di regolazione fine
- Sistema di bloccaggio a vite
- Astuccio in legno

CALIBRO DI PRECISIONE CON BECCHI LUNGI

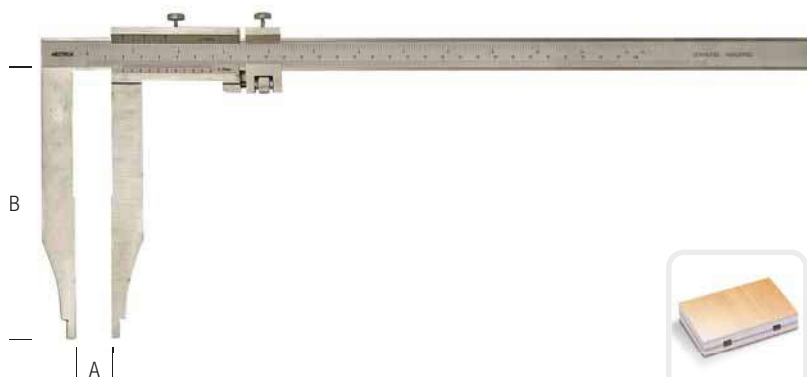

Ref.	A mm	B mm	mm	inch			€
12120	0-300	150	0,02	1/128	8001066121205	1	-
12121	0-500	200	0,02	1/128	8001066121212	1	-
12122	0-600	250	0,02	1/128	8001066121229	1	-
12123	0-800	300	0,02	1/128	8001066121236	1	-

- Acciaio inox temprato
- Scala cromata opaca
- Vite micrometrica di regolazione fine
- **Becchi lunghi per grandi diametri**
- Sistema di bloccaggio a vite
- Astuccio in legno

CALIBRO DI PRECISIONE PER TORNITORI

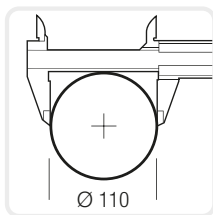
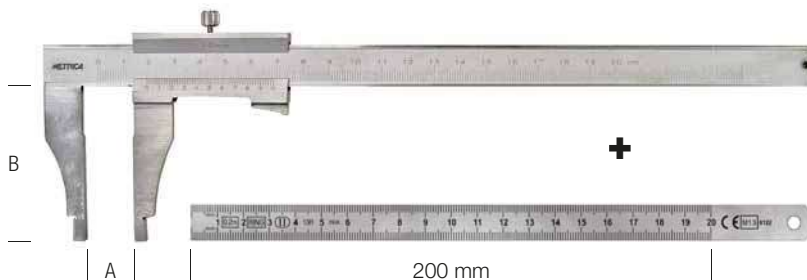

Ref.	A mm	B mm	mm	inch			€
11035	0-200	55	0,02	-	8001066110353	1	-

- Acciaio inox temprato
- Scala cromata opaca
- Becchi lunghi 55 mm per misure di cilindri con diametro fino a 110 mm
- Sistema di bloccaggio a vite
- Fornito con righetta flessibile da 200 mm
- Astuccio in ABS

CALIBRO PER OFFICINA

Ref.	A mm	B mm	mm	inch			€
12050	0-500	80	0,02	—	8001066120505	1	—
12051	0-600	80	0,02	—	8001066120512	1	—
12053	0-1000	125	0,02	—	8001066120536	1	—

- Acciaio inox temprato
- Scala cromata opaca
- Vite micrometrica di regolazione fine
- Sistema di bloccaggio a vite
- Astuccio in legno



CALIBRO DI PRECISIONE CONTROPUNTE PER ESTERNI

Ref.	A mm	B mm	mm	inch			€
12072	0-300	60	0,02	—	8001066120727	1	—

- Acciaio inox temprato
- Scala cromata opaca
- Contropunte per esterni
- Vite micrometrica di regolazione fine
- Sistema di bloccaggio a vite
- Astuccio in legno

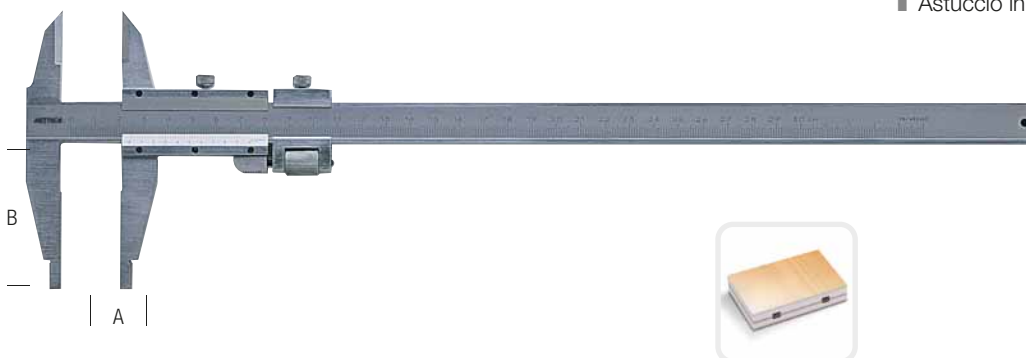

CALIBRO DI PRECISIONE CONTROPUNTE PER INTERNI

Ref.	A mm	B mm	mm	inch			€
12091	0-250	60	0,02	1/128	8001066120918	1	—
12092	0-300	80	0,02	1/128	8001066120925	1	—

- Acciaio inox temprato
- Scala cromata opaca
- Contropunte per interni
- Vite micrometrica di regolazione fine
- Sistema di bloccaggio a vite
- Astuccio in legno

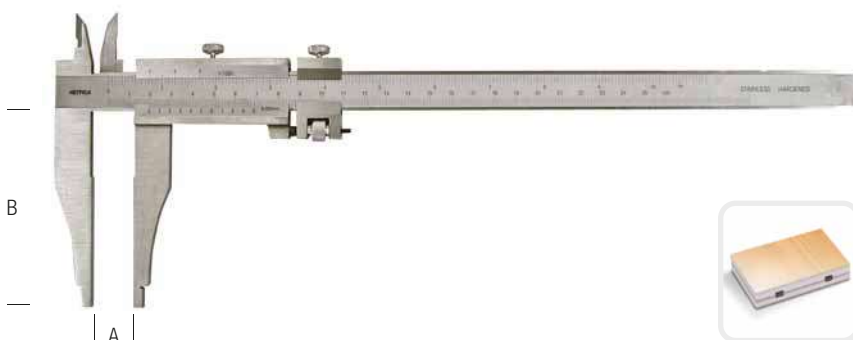

COMPASSO A VERGA

Ref.	A mm	mm inch		8001066480715	1	€
48071	500	0,05	—	8001066480715	1	—
48072	1000	0,05	—	8001066480722	1	—
48073	1500	0,05	—	8001066480739	1	—
48074	2000	0,05	—	8001066480746	1	—

- Acciaio inox
- Scala graduata
- Vite micrometrica di regolazione fine
- Punte in acciaio temprato





CALIBRO PER PIANTE

Ref.	A cm	B cm	mm cm	8001066109036	1	€
10903	60	35	1	8001066109036	1	—
10904	80	45	1	8001066109043	1	—
10905	100	55	1	8001066109050	1	—
10906	120	65	1	8001066109067	1	—

- In alluminio
- Doppia graduazione
- Resistente all'usura





CALIBRO PER SERBATOI

Ref.	A x B mm	mm	L mm			€
10147	580 x 165	1	500	8001066101474	1	—
10148	580 x 165	1	1000	8001066101481	1	—
10149	580 x 165	1	1500	8001066101498	1	—
10150	580 x 165	1	2000	8001066101504	1	—

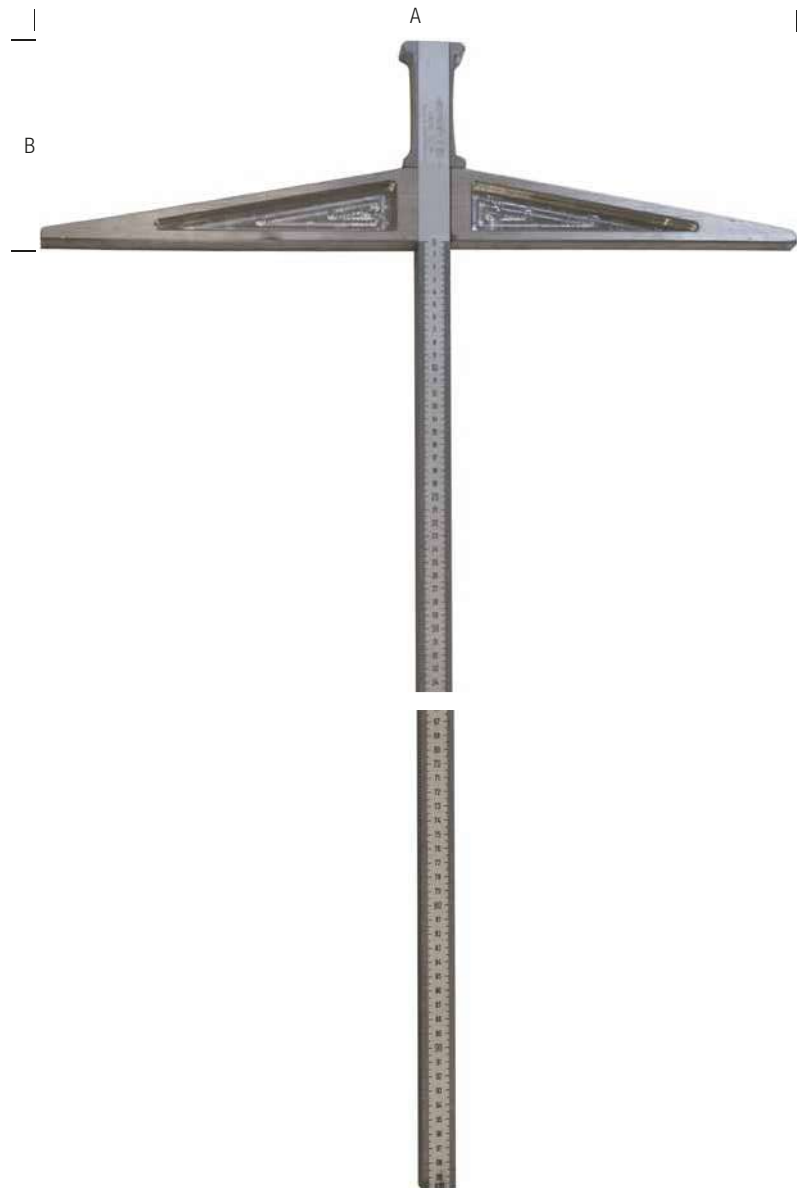
- Asta tubolare graduata in alluminio
- Base in alluminio



RIGA PER PRODOTTI PETROLIFERI

Ref.	A mm	mm	inch			€
24002	2000	1	—	8001066240029	1	—
24003	3000	1	—	8001066240036	1	—
24007	3500	1	—	8001066240074	1	—
24004	4000	1	—	8001066240043	1	—

- Asta tubolare graduata in alluminio
- Puntale in ottone



INDICATORE DIGITALE DI DISTANZA

Ref.	A mm	B mm	mm inch			€
10770	0-150	40	0,1	—	8001066107704	1 —

- Calibro digitale in fibra di carbonio
- Capacità 150 x 0,1 mm
- Dimensioni contenute, leggero, preciso
- Grande display digitale con numeri giganti (in millimetri e inches)
- Bracci con anelli forniti in 3 misure
- Dotato di cacciavite per sostituzione anelli
- Astuccio in ABS
- Modello brevettato



CALIBRO BECCHI IN MATERIALE SINTETICO

Ref.	A cm	B mm	mm inch			€
10460	0-15	10	1	—	8001066104604	1 —

- In alluminio
- Graduazione ossidata indelebile
- Becchi ripiegabili in fibroresina a superficie piana

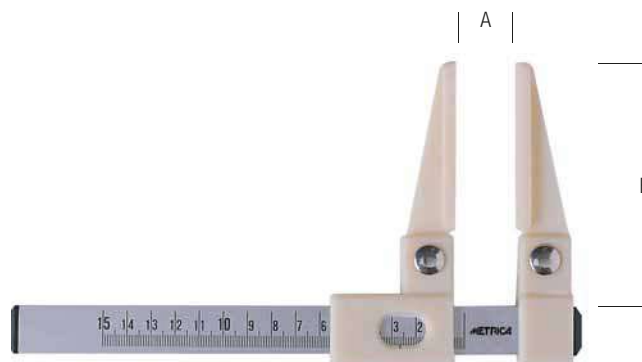

CALIBRO BECCHI LUNGI IN MATERIALE SINTETICO

Ref.	A cm	B cm	cm			€
10455	90	16	0,5	8001066104550	1	—

- In alluminio
- Graduazione ossidata indelebile
- Becchi ripiegabili in fibroresina a superficie piana

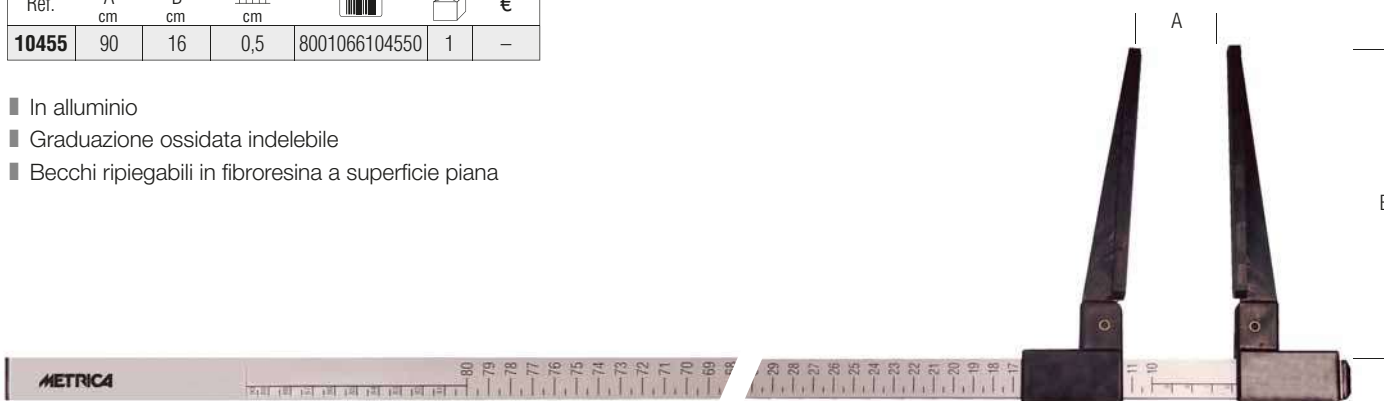

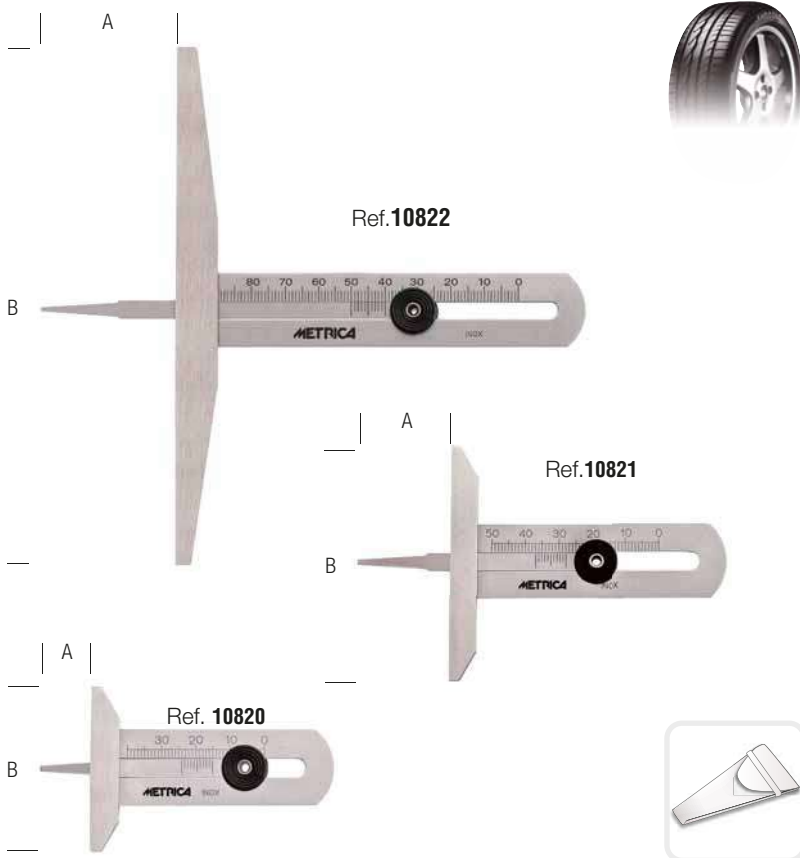

CALIBRO DI PROFONDITÀ PER BATTISTRADA PNEUMATICI

Ref.	A mm	B mm	mm	inch			€
10820	0-30	47	0,1	—	8001066108206	1	—
10821	0-50	70	0,1	—	8001066108213	1	—
10822	0-90	150	0,1	—	8001066108220	1	—

- Acciaio inox
- Spillo sagomato per le scanalature degli pneumatici
- Astuccio in similpelle



MISURATORE A QUADRANTE PER BATTISTRADA PNEUMATICI

Ref.	A mm	B mm	mm	inch			€
43140	0-19	45	0,1	—	8001066431403	1	—

- Stelo a spillo
- Movimento frizionato
- Quadrante a settori colorati per indicazione dello stato di usura del battistrada
- Astuccio in similpelle



CALIBRO DIGITALE PER BATTISTRADA PNEUMATICI

Ref.	A mm	B mm	mm	inch			€
10830	0-27	45	0,01	0,005	8001066108305	1	—

- Corpo in acciaio
- Schermo LCD a 4 cifre
- Tasti: ON/OFF, zero, mm/inch
- Peso: 125 g
- Astuccio in ABS



CONTAFILETTI IN ACCIAIO



Ref.	N				€	Ref.			€
35020	52	Withw SI	8001066350209	5	-	05020	8001066050208	5	-
35021	58	Withw SI	8001066350216	5	-	05021	8001066050215	5	-
35022	28	Withw	8001066350223	5	-	05022	8001066050222	5	-
35023	24	SI	8001066350230	5	-	05023	8001066050239	5	-
35024	30	USS-NC	8001066350247	5	-	05024	8001066050246	5	-

RAGGIMETRO IN ACCIAIO

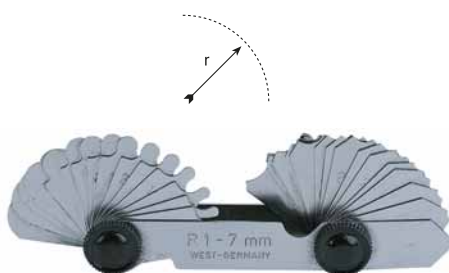

Ref.				€	Ref.			€
35041	1 ÷ 7 mm	8001066350414	1	-	05041	8001066050413	5	-
35042	7,5 ÷ 15 mm	8001066350421	1	-	05042	8001066050420	5	-
35043	15,5 ÷ 25 mm	8001066350438	1	-	05043	8001066050437	5	-

■ Per rilevare il raggio di forme concave e convesse

SPESSIMETRI



Ref.	S mm	L mm	N			€	Ref.			€
35100	0,05 ÷ 0,50	100	8	8001066351008	5	-	05100	8001066051007	5	-
35101	0,05 ÷ 1	100	13	8001066351015	5	-	05101	8001066051014	5	-
35102	0,05 ÷ 1	100	20	8001066351022	5	-	05102	8001066051021	5	-
35103	0,05 ÷ 2	100	20	8001066351039	1	-	05103	8001066051038	5	-
35104	0,10 ÷ 0,30	75	5	8001066351046	4	-	05104	8001066051045	5	-
35105	0,03 ÷ 0,10	100	8	8001066351053	4	-	05105	8001066051052	5	-

■ Custodia in metallo

N = numero di lame

SPESSIMETRO A LAME LUNGHE

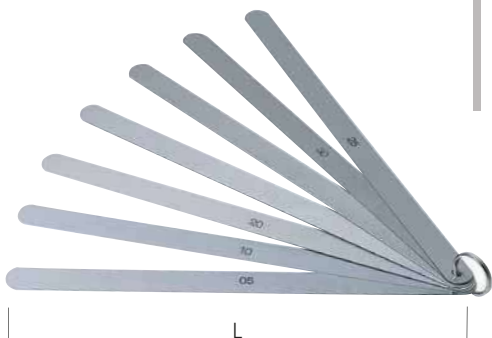

Ref.	S mm	L mm	N			€
35080	0,05 ÷ 0,50	200	8	8001066350803	1	-
35081	0,05 ÷ 0,50	300	8	8001066350810	1	-
35082	0,05 ÷ 1	300	13	8001066350827	1	-
35083	0,05 ÷ 1	500	13	8001066350834	1	-
35084	0,05 ÷ 1	300	20	8001066350841	1	-
35085	0,05 ÷ 1	500	20	8001066350858	5	-

■ Larghezza 13 mm

N = numero di lame

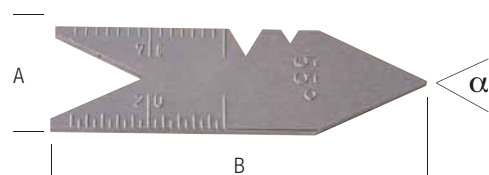

CALIBRO IN ACCIAIO PROFILI UTENSILI

Ref.	A mm	B mm	α			€
35010	20	65	55°	8001066350100	1	–
35011	20	65	60°	8001066350117	1	–

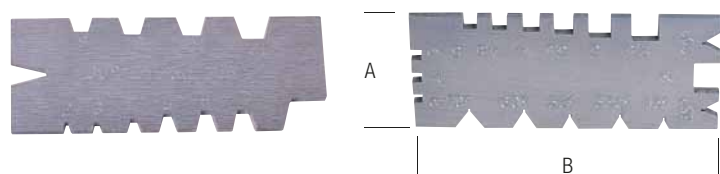

CALIBRO UNIVERSALE IN ACCIAIO

Ref.	A mm	B mm			€
35015	25	60	8001066350155	1	–
35018	25	60	8001066350186	1	–

Ref. **35018**: profili utensili

Ref. **35015**: filetti trapezi

MISURATORE CONICO PER FORI

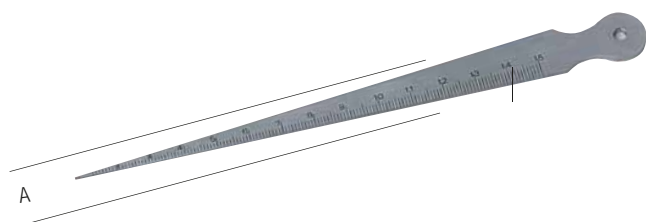

Ref.	A mm			€
35078	$\emptyset 0 \div 15$	8001066350780	1	–

- Stelo conico graduato, in acciaio
- Lettura diretta del diametro

CALIBRO A TAMPONCINI PER FORI



Ref.	A mm			€
35070	$\emptyset 0,45 \div 1,5$	8001066350704	1	–
35071	$\emptyset 1,5 \div 3$	8001066350711	1	–

- Tamponcini in acciaio temprato misura il diametro dei fori

NASTRO CALBRATO IN BOBINE



Ref.	S mm	L mm	B mm			€
35129	0,05	5	13	8001066351299	1	–
35134	0,10	5	13	8001066351343	1	–
35135	0,15	5	13	8001066351350	1	–
35136	0,20	5	13	8001066351367	1	–
35140	0,40	5	13	8001066351404	1	–
35142	0,50	5	13	8001066351428	1	–
35143	1,00	5	13	8001066351435	1	–

- Larghezza 13 mm, lunghezza 5 m
- In custodia



MICROMETRO PER ESTERNI

Ref.	A mm	mm	inch			€
44061	0 - 25	0,01	—	8001066440610	1	—
44062	25 - 50	0,01	—	8001066440627	1	—
44063	50 - 75	0,01	—	8001066440634	1	—
44064	75 - 100	0,01	—	8001066440641	1	—

- Lettura 0,01 mm
- Arco cromato
- Contatti in metallo duro, Ø 6,5 mm
- Tamburo Ø 18 mm
- Leva di bloccaggio
- Astuccio in ABS
- Precisione secondo DIN 863

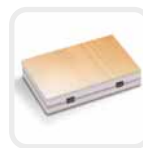
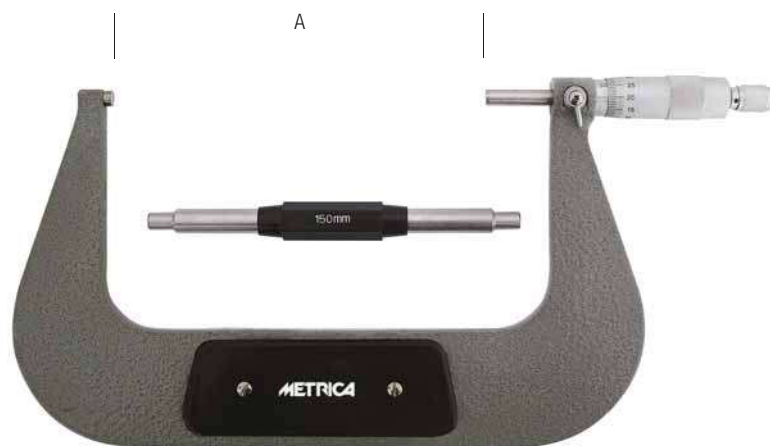

MICROMETRO PER ESTERNI

Ref.	A mm	mm	inch			€
44065	100 - 125	0,01	—	8001066440658	1	—
44066	125 - 150	0,01	—	8001066440665	1	—
44067	150 - 175	0,01	—	8001066440672	1	—
44068	175 - 200	0,01	—	8001066440689	1	—
44069	200 - 225	0,01	—	8001066440696	1	—

- Lettura 0,01 mm
- Arco verniciato
- Contatti in metallo duro Ø 6,5 mm
- Tamburo Ø 18 mm
- Leva di bloccaggio
- Astuccio in legno
- Precisione secondo DIN 863

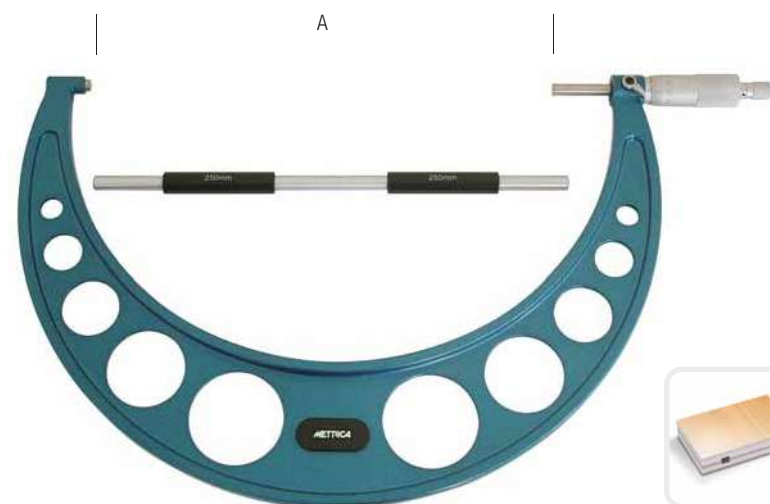

MICROMETRO PER ESTERNI

Ref.	A mm	mm	inch			€
44080	225 - 250	0,01	—	8001066440801	1	—
44095	250 - 275	0,01	—	8001066440955	1	—
44096	275 - 300	0,01	—	8001066440962	1	—

- Lettura 0,01 mm
- Arco verniciato
- Contatti in metallo duro Ø 6,5 mm
- Tamburo Ø 18 mm
- Leva di bloccaggio
- Astuccio in legno
- Precisione secondo DIN 863

MICROMETRO DA OFFICINA



Ref.	A mm	mm	inch			€
44130	0 - 25	0,01	—	8001066441303	1	—
44122	25 - 50	0,01	—	8001066441228	1	—
44123	50 - 75	0,01	—	8001066441235	1	—
44124	75 - 100	0,01	—	8001066441242	1	—

- Micrometro per officina
- Contatti in metallo duro
- Arco verniciato
- Leva di bloccaggio
- Astuccio in ABS

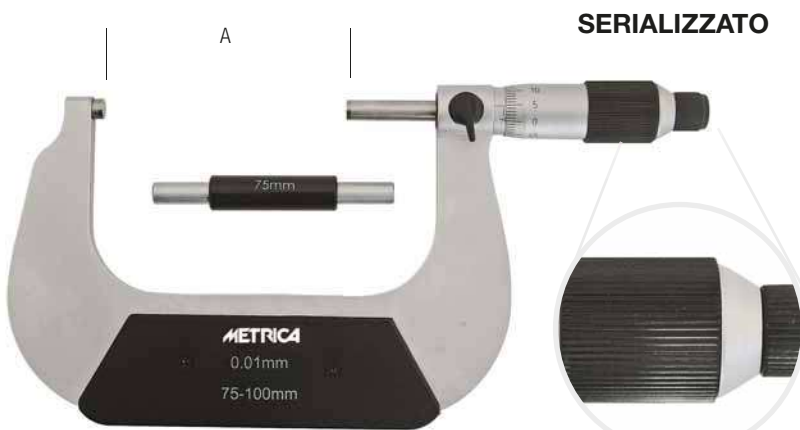

MICROMETRO FRIZIONE SUL TAMBURO

Ref.	A mm	mm	inch			€
44351	0 - 25	0,01	—	8001066443512	1	—
44352	25 - 50	0,01	—	8001066443529	1	—
44353	50 - 75	0,01	—	8001066443536	1	—
44354	75 - 100	0,01	—	8001066443543	1	—

- Frizione sul tamburo, consente la misura con una sola mano
- Contatti in metallo duro
- Leva di bloccaggio
- Passo vite 0,5 mm
- Astuccio in ABS

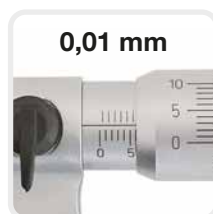

MICROMETRO MILLESIMALE SENZA PARALLASSE

Ref.	A mm	mm	inch			€
44371	0 - 25	0,01	0,001	8001066443710	1	—
44372	25 - 50	0,01	0,001	8001066443727	1	—
44373	50 - 75	0,01	0,001	8001066443734	1	—
44374	75 - 100	0,01	0,001	8001066443741	1	—

- Doppia lettura: 0,01 mm sul tamburo, 0,001 mm sul nonio senza parallasse
- Frizione sul tamburo, consente la misura con una sola mano
- Contatti in metallo duro
- Arco cromato
- Leva di bloccaggio
- Passo vite: 0,5 mm
- Stelo: Ø 6,5 mm
- Astuccio
- Precisione DIN 863



MICROMETRO ELETTRONICO DIGITALE

Ref.	A mm	mm	inch			€
44210	0-25	0,001	0.0005	8001066442102	1	-
44211	25-50	0,001	0.0005	8001066442119	1	-
44212	50-75	0,001	0.0005	8001066442126	1	-
44213	75-100	0,001	0.0005	8001066442133	1	-

- Display digitale a 5 cifre
- **Protezione IP 54**
- Realizzato secondo DIN863
- Pulsanti: ON/OFF, Set, ABS, mm/inch
- **Risoluzione** 0,001 mm
- Incudine e fusto in metallo duro

Non vendibile in DE / UK / USA / JAP



MICROMETRO ELETTRONICO DIGITALE IP65

Ref.	A mm	mm	inch			€
44230	0-25	0,001	0.0005	8001066442300	1	-

- Display digitale a 5 cifre
- **Protezione IP 65**
- Realizzato secondo DIN863
- Pulsanti: ON/OFF, Origin, ABS/0, mm/inch
- **Risoluzione** 0,001 mm
- Incudine e fusto in metallo duro

Non vendibile in DE / UK / USA / JAP



MICROMETRO ELETTRONICO DIGITALE A MOVIMENTO RAPIDO

Ref.	A mm	mm	inch			€
44220	0-25	0,001	0.0005	8001066442201	1	-

- Movimento rapido a leva
- Display digitale a 5 cifre
- **Protezione IP 65**
- Realizzato secondo DIN863
- Pulsanti: ON/OFF, Origin, ABS/0, mm/inch
- **Risoluzione** 0,001 mm
- Incudine e fusto in metallo duro

Non vendibile in DE / UK / USA / JAP

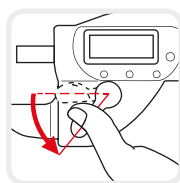

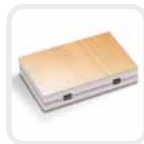

MICROMETRO ELETTRONICO DIGITALE

Ref.	A mm	mm	inch			€
44202	0 - 25	0,001	0,0005	8001066442027	1	—
44203	25 - 50	0,001	0,0005	8001066442034	1	—
44204	50 - 75	0,001	0,0005	8001066442041	1	—
44205	75 - 100	0,001	0,0005	8001066442058	1	—

- Display digitale a 5 cifre
- Alta precisione
- Lettura 0,001 mm
- Azzeramento per misure comparative
- Indicazione digitale di tolleranza
- Astuccio in legno

Non in vendita in Germania, UK, USA e JAP

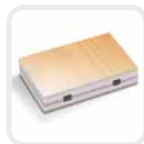
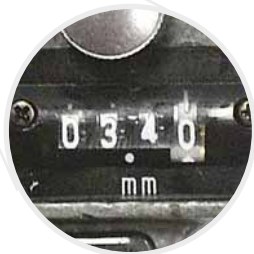

MICROMETRO CON CONTATORE

Ref.	A mm	mm	inch			€
44300	0 - 25	0,01	—	8001066443000	1	—
44301	25 - 50	0,01	—	8001066443017	1	—

- Contatti in metallo duro
- Contatore
- Lettura 0,01 mm
- Arco verniciato
- Astuccio in legno

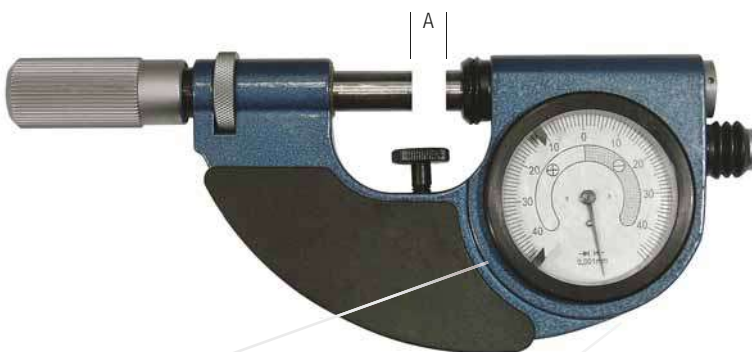

MICROMETRO CON COMPARATORE

Ref.	A mm	mm	inch			€
44381	0 - 25	0,001	—	8001066443819	1	—

- Incudine mobile millesimale
- Risoluzione 0,001 mm
- Astuccio



SET DI MICROMETRI PER ESTERNI

Ref.	A mm	mm	inch			€
44098	0-100	0,01	—	8001066440986	1	—
44099	0-150	0,01	—	8001066440993	1	—

- Disposti in verticale
- Stesse caratteristiche art. 44061 ÷ 44066
- Astuccio in legno

Ref. **44098**: 4 pezzi
0÷25 | 25÷50 | 50÷75 | 75÷100

Ref. **44099**: 6 pezzi
0÷25 | 25÷50 | 50÷75 | 75÷100 | 100÷125 | 125÷150

- Cono 60°
- Ø 6,5 mm arrotondato
- Lama spessore 1 mm
- Ø 6,5 mm piatto
- Ø 2 mm punta
- 60° lama



MICROMETRO UNIVERSALE CON CONTATTI INTERCAMBIABILI

Ref.	A mm	mm	inch			€
44026	25 - 50	0,01	—	8001066440269	1	—
44027	50 - 75	0,01	—	8001066440276	1	—
44028	75 - 100	0,01	—	8001066440283	1	—

- 6 coppie aggiuntive di contatti intercambiabili
- Contatti in acciaio temprato
- Arco verniciato
- Frizione sul tamburo
- Astuccio in legno

MICROMETRO PER INTERNI AD ASTE COMBINABILI

Ref.	A mm	mm	inch			€
44111	50 - 150	0,01	—	8001066441112	1	—
44114	50 - 600	0,01	—	8001066441143	1	—
44115	50 - 800	0,01	—	8001066441150	1	—
44116	75 - 1075	0,01	—	8001066441167	1	—
44117	75 - 1575	0,01	—	8001066441174	1	—

- Lettura 0,01 mm
- Precisione testa micrometrica secondo DIN 863
- Astuccio in legno





12-20	3 anelli
20-40	4 anelli
40-100	4 anelli

MICROMETRO A TRE PUNTE

Ref.	A mm	mm	inch			€
44250	12 - 20	0,005	—	8001066442508	1	—
44251	20 - 40	0,005	—	8001066442515	1	—
44252	40 - 100	0,005	—	8001066442522	1	—

- Lettura 0,005 mm
- Include anelli di riscontro
- In valigetta di alluminio
- Prolunga

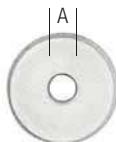

MICROMETRO PER INTERNI

Ref.	A mm	mm	inch			€
44101	5 - 30	0,01	—	8001066441013	1	—
44102	25 - 50	0,01	—	8001066441020	1	—
44103	50 - 75	0,01	—	8001066441037	1	—
44104	75 - 100	0,01	—	8001066441044	1	—

- Lettura 0,01 mm
- Con becchi
- Include anello di riscontro (Ref. **44101** e **44102**)
- Astuccio in legno
- Precisione DIN 863

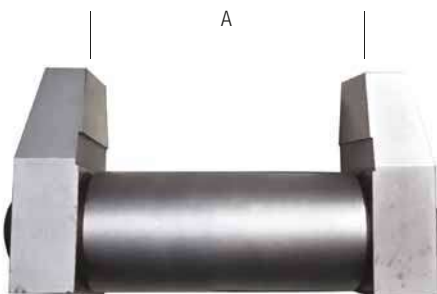

CALIBRO DI CONTROLLO

Ref.	A			€
44106	50 mm	8001066441068	1	—
44107	75 mm	8001066441075	1	—

- Per Ref. **44103** e **44104**



MICROMETRO PER FILI

Ref.	A mm	mm	inch			€
44010	0 - 10	0,01	—	8001066440108	1	—

- Lettura 0,01 mm
- In astuccio



MICROMETRO DI PROFONDITÀ

Ref.	A mm	mm	inch			€
44090	0 - 100	100	0,01	8001066440900	1	—
44091	0 - 200	100	0,01	8001066440917	1	—

- Lettura 0,01 mm
- Lunghezza ponte 100 mm
- Astuccio in legno
- Precisione DIN 863

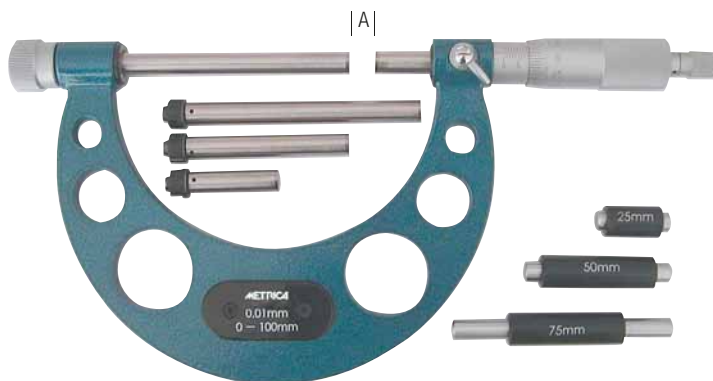

MICROMETRO AD INCUDINE INTERCAMBIABILE

Ref.	A mm	mm	inch			€
44040	0 - 100	0,01	—	8001066440405	1	—
44041	100 - 200	0,01	—	8001066440412	1	—

- Arco verniciato
- Contatti in metallo duro Ø 8 mm
- Tamburo Ø 18 mm
- Leva di bloccaggio
- Incudine intercambiabile
- Astuccio in legno

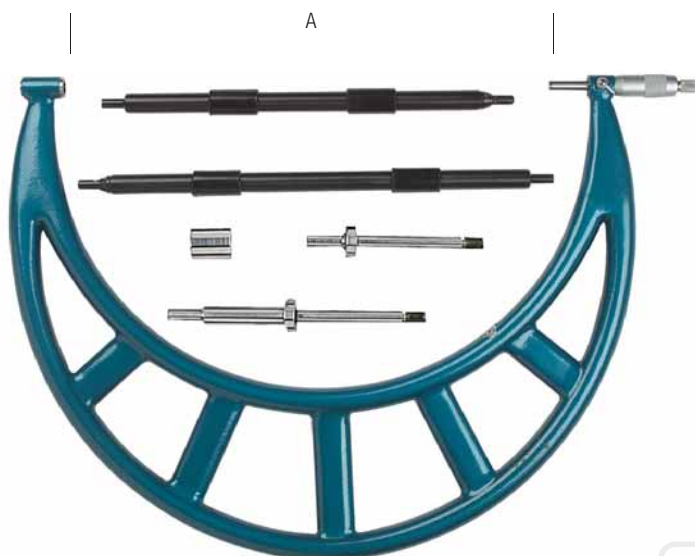

MICROMETRO PER GRANDI DIAMETRI

Ref.	A mm	mm	inch			€
44081	200 - 300	0,01	—	8001066440818	1	—
44082	300 - 400	0,01	—	8001066440825	1	—
44083	400 - 500	0,01	—	8001066440832	1	—
44084	500 - 600	0,01	—	8001066440849	1	—
44085	600 - 700	0,01	—	8001066440856	1	—
44086	700 - 800	0,01	—	8001066440863	1	—
44087	800 - 900	0,01	—	8001066440870	1	—
44088	900 - 1000	0,01	—	8001066440887	1	—

- Arco in struttura tubolare leggera e robusta
- Contatti in metallo duro Ø 6,5 mm
- Tamburo Ø 18 mm
- Leva di bloccaggio
- Incudine intercambiabile
- Lettura 0,01 mm
- Astuccio in legno
- Precisione DIN 863



**MICROMETRO
PER INGRANAGGI**

Ref.	A mm	mm	inch			€
44021	0 - 25	0,01	-	8001066440214	1	-

- Per ingranaggi
- Arco verniciato
- Astuccio in ABS



**MICROMETRO A DISCO
PER LAMIERE**

Ref.	A mm	mm	inch			€
44030	0 - 15	0,01	-	8001066440306	1	-

- Lettura 0,01 mm ad indice su disco graduato
- Astuccio in legno



**MICROMETRO
PER TUBI**

Ref.	A mm	mm	inch			€
44120	0 - 25	0,01	-	8001066441204	1	-

- Lettura 0,01 mm
- Bloccaggio a ghiera
- Astuccio in abs





COMPARATORE DI PRECISIONE PICCOLO DIAMETRO

Ref.	A mm	B mm	mm	inch			€
41010	0 - 5	Ø 40	0,01	-	8001066410101	1	-

- Quadrante girevole con indici di tolleranza
- Precisione secondo DIN 878
- Astuccio in abs

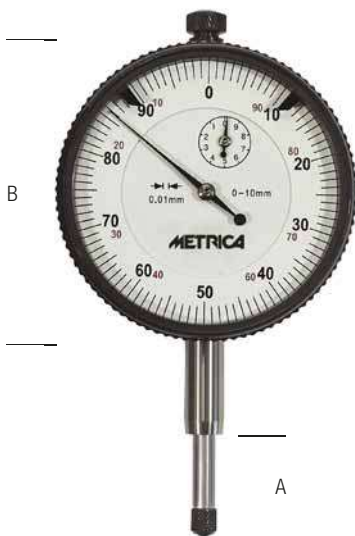

COMPARATORE DI PRECISIONE

Ref.	A mm	B mm	mm	a	b			€
41020	0 - 10	Ø 58	0,01	•	•	8001066410200	1	-
41025	0 - 30	Ø 58	0,01	•		8001066410255	1	-
41026	0 - 30	Ø 58	0,01	•		8001066410262	1	-

- Comparatore ad alta sensibilità, esecuzione robusta
- Quadrante girevole con indici di tolleranza
- Precisione secondo DIN 878
- Astuccio in ABS

Ref. **41020**: fornito con piattello supplementare ad anello

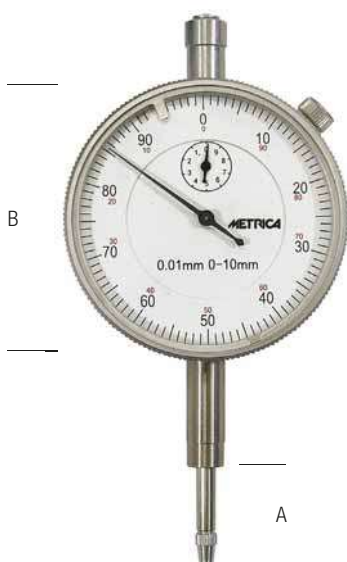
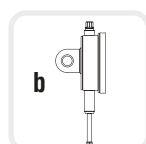
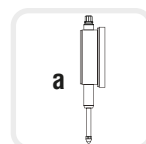

COMPARATORE DI PRECISIONE

Ref.	A mm	B mm	mm	inch			€
41019	0 - 10	Ø 58	0,01	-	8001066410194	1	-

- Quadrante girevole con bottone di bloccaggio
- Indici di tolleranza
- Astuccio in abs



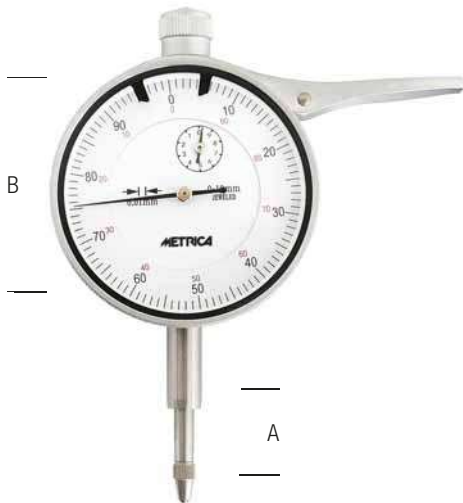

COMPARATORE CON LEVETTA DI SOLLEVAMENTO

Ref.	A mm	B mm	mm	inch			€
41090	0 - 10	Ø 58	0,01	-	8001066410903	1	-

- Quadrante girevole
- Indici di tolleranza
- Dotato di **levetta di sollevamento**
- Astuccio in ABS

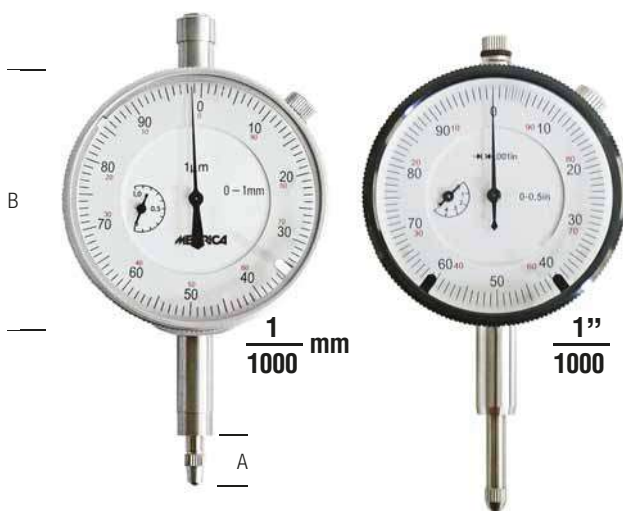

Ref. 41028

Ref. 41027

COMPARATORE MILLESIMALE

Ref.	A mm	B mm	mm	inch			€
41028	0 - 1	Ø 58	0,001	-	8001066410286	1	-
41027	0-0,40"	Ø 58	-	1"/1000	8001066410279	1	-

- Comparatore **millesimale** ad alta sensibilità
- Bottone di bloccaggio
- Quadrante girevole con indici di tolleranza
- Astuccio in ABS



COMPARATORE DI PRECISIONE GRANDE DIAMETRO

Ref.	A mm	B mm	mm	inch			€
41052	0 - 30	Ø 75	0,01	-	8001066410521	1	-
41053	0 - 50	Ø 75	0,01	-	8001066410538	1	-

- Quadrante di **grande dimensione** con indici di tolleranza
- Astuccio in ABS

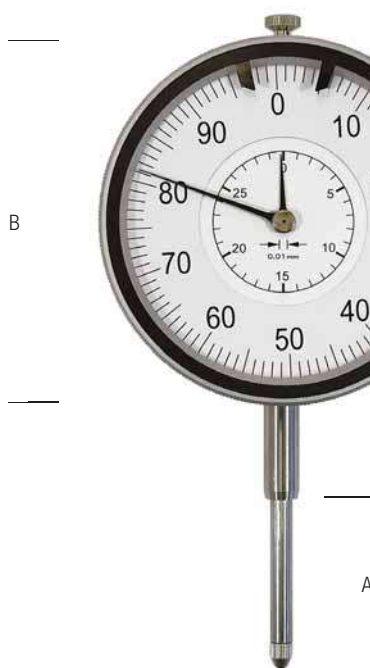



COMPARATORE DIGITALE AD ALTA VISIBILITÀ

Ref.	A mm	B mm	mm	inch			€
41150	0-12,5	Ø 56	0,01	0,0005	8001066411504	1	-

- Schermo LCD ad alta visibilità - numeri giganti
- Funzione ABS
- Risoluzione 0,01 mm/0,0005"
- Precisione 0,02 mm/0,001"
- Range 12,5 mm
- Pulsanti: ON/OFF, zero, ABS, mm/inch, TOL
- Uscita dati jack std a 4 vie 2,5 mm
- Output dati
- Astuccio in ABS

Non vendibile in UK, DE, USA, JAP



COMPARATORE DIGITALE

Ref.	A mm	B mm	mm	inch			€
41080	0 - 12	Ø 58	0,01	0,0005	8001066410804	1	-
41085	0 - 12	Ø 58	0,001	0,00005	8001066410859	1	-

- Display digitale
- Lettura mm/inch
- Alta precisione
- Azzeramento per misure comparative
- Impostazione dei limiti di tolleranza
- Astuccio in ABS

Ref. **41080**: lettura 0,01 mm

Ref. **41085**: lettura 0,001 mm



COMPARATORE A TASTO ORIENTABILE

Ref.	A mm	B mm	mm	inch			€
41017	± 0,8	Ø 32	0,01	-	8001066410170	1	-

- Tasto orientabile con supporto snodato
- Astuccio in legno

SUPPORTO DI CENTRATURA

Per Ref. 41017 , a mezzaluna stelo Ø 4 x 25 mm	Ref.			€
	41018	8001066410187	1	-





ALESAMETRO DI PRECISIONE

Ref.	A mm	L mm			€
42010	15 ÷ 35	200	8001066420100	1	–
42020	30 ÷ 100	300	8001066420209	1	–
42030	50 ÷ 178	300	8001066420308	1	–
42040	100 ÷ 300	300	8001066420407	1	–
42032	50 ÷ 178	450	8001066420322	1	–

- Contatti in acciaio temprato
- Astuccio in legno
- Fornito senza comparatore

ALESAMETRO CONTATTI IN METALLO DURO

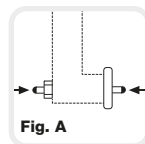

Ref.	A mm	L mm			€
42110	15 ÷ 35	200	8001066421107	1	–
42120	30 ÷ 100	300	8001066421206	1	–
42130	50 ÷ 178	300	8001066421305	1	–
42140	100 ÷ 300	300	8001066421404	1	–

- Tastatore mobile e prolungha **con contatti in metallo duro** (Fig. A)
- Astuccio in legno
- Fornito senza comparatore

BLOCCHETTI DI RISCOTTO



Ref.	N mm				€
28060	32	grad. 0	8001066280605	1	–
28050	32	grad. I	8001066280506	1	–
28051	32	grad. II	8001066280513	1	–
28052	47	grad. I	8001066280520	1	–
28053	47	grad. II	8001066280537	1	–
28054	87	grad. I	8001066280544	1	–
28055	87	grad. II	8001066280551	1	–
28056	103	grad. I	8001066280568	1	–
28057	103	grad. II	8001066280575	1	–

- Acciaio legato
- Elevata stabilità e resistenza all'usura
- Astuccio in legno
- **Certificazione individuale a richiesta**



ALESAMETRO PER BRONZINE

Ref.	A mm	L mm			€
42204	35 ÷ 105	—	8001066422043	1	—
42205	100 ÷ 210	—	8001066422050	1	—

- Sagomato a L per bronzine
- Con asta scorrevole graduata regolabile
- Fornito senza comparatore
- In astuccio

REGISTRATORE UTENSILI PER ALESATRICI



Ref.	A mm	A inch				€
42223	37,5	—	0,01	8001066422234	1	—
42224	—	1,51	—	8001066422241	1	—

- Con comparatore a ventaglio MAHR
- Lettura 0,01 mm
- Corsa ± 0,40 mm
- Micrometro con bloccaggio a vite

REGISTRATORE UTENSILI PER ALESATRICI



Ref.	A mm	A mm				€
42225	37,5	—	0,01	8001066422258	1	—

- Con comparatore a quadrante circolare Ø 40 mm
- Lettura 0,01 mm
- Corsa ± 0,40 mm
- Micrometro con bloccaggio a vite



MISURATORE DI SPESSORE A PINZA

Ref.	C mm	P mm	mm	inch			€
70200	0 - 40	120	0,2	-	8001066702008	1	-

- Misuratore di spessore a pinza analogico
- Lettura 0,2 mm
- Astuccio in legno



MISURATORE DI SPESSORE A PINZA DIGITALE CON USCITA DATI

Ref.	C mm	P mm	mm	inch			€
70206	0 - 40	120	0,01	-	8001066702060	1	-

- Misuratore di spessore a pinza digitale con uscita dati
- In astuccio

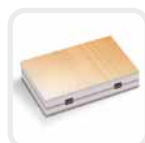

KIT TRASMISSIONE DATI

Ref.				€
10835	WIRELESS	8001066108350	1	-
10836	WIRE	8001066108367	1	-



MISURATORE RAPIDO DI SPESSORE

Ref.	A mm	B mm	mm			€
43180	0 - 10	35	0,1	8001066431809	1	-
43181	0 - 10	63	0,1	8001066431816	1	-

- Misuratore rapido di spessore
- Lettura 0,1 mm





MISURATORE DI SPESSORE TASCABILE CENTESIMALE

Ref.	C mm	P mm	mm				€
43030	0 - 5	25	0,01	A	8001066430307	1	-

- Lettura 0,01 mm
- Esecuzione tascabile
- Con impugnatura e levetta di sollevamento

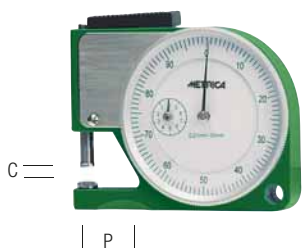

MISURATORE DI SPESSORE TASCABILE CENTESIMALE

Ref.	C mm	P mm	mm				€
43031	0 - 12	15	0,01	E	8001066430314	1	-

- Lettura 0,01 mm
- Esecuzione tascabile
- Esecuzione extrapiatta

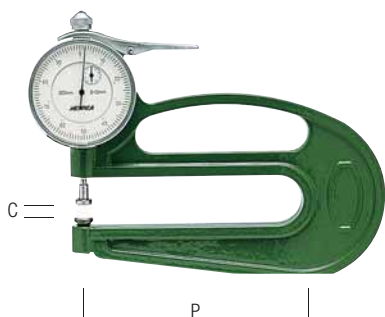

MISURATORE DI SPESSORE A QUADRANTE

Ref.	C mm	P mm	mm				€
43032	0 - 10	50	0,01	A	8001066430321	1	-
43037	0 - 10	120	0,01	A	8001066430376	1	-
43034	0 - 10	200	0,01	A	8001066430345	1	-

- Lettura 0,01 mm
- Supporto in alluminio
- Leva di sollevamento

CONTATTI IN ACCIAIO INOX RETTIFICATO

(altre esecuzioni speciali a richiesta)

A



B



C

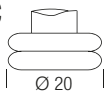

D



E



F



K



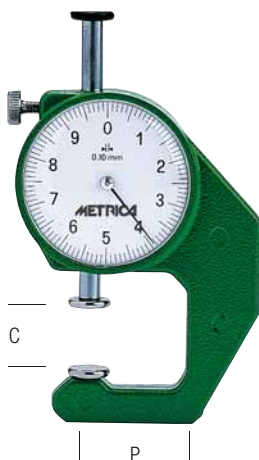

MISURATORE DI SPESSORE TASCABILE DECIMALE

Ref.	C mm	P mm	mm				€
43051	0 - 10	20	0,1	A	8001066430512	1	—
43052	0 - 20	20	0,1	A	8001066430529	1	—
43068	0 - 20	20	0,1	B	8001066430680	1	—
43053	0 - 20	50	0,1	A	8001066430536	1	—
43069	0 - 20	50	0,1	B	8001066430697	1	—
43054	0 - 30	50	0,1	A	8001066430543	1	—

- Lettura 0,1 mm
- Esecuzione tascabile con bloccaggio
- Forma ergonomica
- Supporto in alluminio e vernice anticivolo
- Astuccio in similpelle

MISURATORE DI SPESSORE A QUADRANTE DECIMALE



Ref.	C mm	P mm	mm				€
43055	0 - 30	200	0,1	F	8001066430550	1	—
43049	0 - 30	200	0,1	K	8001066430499	1	—
43056	0 - 30	300	0,1	F	8001066430567	1	—
43061	0 - 30	300	0,1	K	8001066430611	1	—
43057	0 - 30	450	0,1	F	8001066430574	1	—
43059	0 - 50	300	0,1	F	8001066430598	1	—
43060	0 - 50	500	0,1	F	8001066430604	1	—

- Lettura 0,1 mm
- Impugnatura ergonomica
- Supporto in alluminio e vernice antigraffio
- Leva di sollevamento



MISURATORE DI SPESSORE A QUADRANTE PER INTERNI

Ref.	C mm	P mm	mm				€
43100	15 - 35	75	0,01	D	8001066431007	1	—
43101	35 - 55	85	0,01	D	8001066431014	1	—
43102	55 - 75	100	0,01	D	8001066431021	1	—

- Lettura 0,01 mm



MISURATORE DI SPESSORE A QUADRANTE PER ESTERNI

Ref.	C mm	P mm	mm				€
43120	0 - 20	60	0,01	D	8001066431205	1	—
43121	20 - 40	60	0,01	D	8001066431212	1	—
43122	40 - 60	60	0,01	D	8001066431229	1	—

- Lettura 0,01 mm

RIGHE A LETTURA FACILITATA



SEZIONE
15 x 0,5 mm



SEZIONE
30 x 1 mm

SCALA SATINATA

Ref.	L mm	B	mm	Barcode	€
24300	150	15 x 0,5	mm	8001066243006	1 -
24301	200	15 x 0,5	mm	8001066243013	1 -
24303	300	15 x 0,5	mm	8001066243037	1 -
24320	300	30 x 1	mm	8001066243204	1 -
24321	500	30 x 1	mm	8001066243211	1 -
24322	1000	30 x 1	mm	8001066243228	1 -

- Graduazione a tratti di lunghezza variabile per una lettura facilitata - design registrato
- Punti alternati ogni 2 mm
- Presa facilitata dall'estremità ripiegata (escluso modello da 1 metro)
- Acciaio inox satinato
- Graduazione indelebile
- Bordi rettificati
- Sez. 15 x 0,5 mm e 30 x 1 mm

Non in vendita in USA e JAP



YouTube

RIGHETTA FLESSIBILE SCALA LUCIDA O SATINATA

- Sezione 13 x 0,5 mm
- Acciaio inox
- Graduazione indelebile
- Bordi rettificati



SCALA LUCIDA

L mm	mm/mm	mm/½mm	mm/inch	Ref.	Barcode	Quantity	€
150	•			24051	8001066240517	5	-
200	•			24052	8001066240524	5	-
250	•			24053	8001066240531	5	-
300	•			24054	8001066240548	5	-
150		•		24031	8001066240319	5	-
200		•		24032	8001066240326	5	-
250		•		24033	8001066240333	5	-
300		•		24034	8001066240340	5	-
150			•	24011	8001066240111	5	-
200			•	24012	8001066240128	5	-
250			•	24013	8001066240135	5	-
300			•	24014	8001066240142	5	-

SCALA SATINATA

L mm	mm/mm	mm/½mm	mm/inch	Ref.	Barcode	Quantity	€
150	•			24061	8001066240616	5	-
200	•			24062	8001066240623	5	-
250	•			24063	8001066240630	5	-
300	•			24064	8001066240647	5	-
150		•		24041	8001066240418	5	-
200		•		24042	8001066240425	5	-
250		•		24043	8001066240432	5	-
300		•		24044	8001066240449	5	-
150			•	24021	8001066240210	5	-
200			•	24022	8001066240227	5	-
250			•	24023	8001066240234	5	-
300			•	24024	8001066240241	5	-

RIGA FLESSIBILE SCALA LUCIDA O SATINATA

- Sezione 20 x 0,5 mm
- Acciaio inox
- Graduazione indelebile

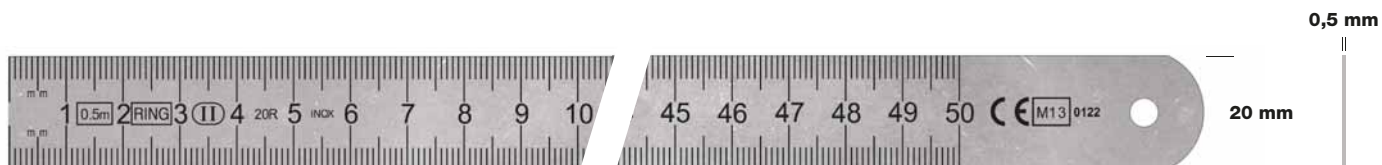

SCALA LUCIDA

L mm	mm/mm	mm/½mm	mm/inch	Ref.	Barcode	Quantity	€
500	•			24072	8001066240722	1	-
1000	•			24073	8001066240739	1	-
500		•		24075	8001066240753	1	-
1000		•		24076	8001066240760	1	-
500			•	24092	8001066240920	1	-
1000			•	24093	8001066240937	1	-

SCALA SATINATA

L mm	mm/mm	mm/½mm	mm/inch	Ref.	Barcode	Quantity	€
500	•			24082	8001066240821	1	-
1000	•			24083	8001066240838	1	-
500		•		24085	8001066240852	1	-
1000		•		24086	8001066240869	1	-
500			•	24102	8001066241026	1	-
1000			•	24103	8001066241033	1	-

RIGA SEMIRIGIDA LUCIDA O SATINATA

- Sezione 30 x 1 mm
- Acciaio inox
- Graduazione indelebile
- Bordi rettificati

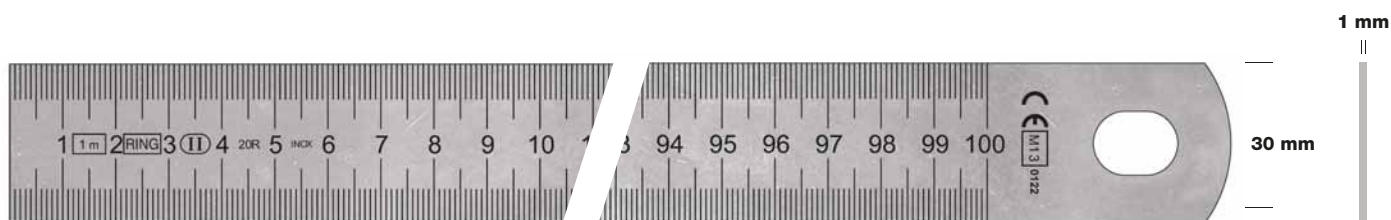

SCALA LUCIDA

L mm	mm/mm	mm/½mm	mm/inch	Ref.	Barcode	Box	€
300	•			25101	8001066251018	1	–
500	•			25102	8001066251025	1	–
700	•			25096	8001066250967	1	–
1000	•			25103	8001066251032	1	–
1500	•			25104	8001066251049	1	–
2000	•			25105	8001066251056	1	–
3000	•			25106	8001066251063	1	–
300		•		25121	8001066251216	1	–
500		•		25122	8001066251223	1	–
1000		•		25123	8001066251230	1	–
1500		•		25124	8001066251247	1	–
2000		•		25125	8001066251254	1	–
3000		•		25126	8001066251261	1	–
300			•	25141	8001066251414	1	–
500			•	25142	8001066251421	1	–
1000			•	25143	8001066251438	1	–
1500			•	25144	8001066251445	1	–
2000			•	25145	8001066251452	1	–
3000			•	25146	8001066251469	1	–

SCALA SATINATA

L mm	mm/mm	mm/½mm	mm/inch	Ref.	Barcode	Box	€
300	•			25111	8001066251117	1	–
500	•			25112	8001066251124	1	–
700	•			–	–	–	–
1000	•			25113	8001066251131	1	–
1500	•			25114	8001066251148	1	–
2000	•			25115	8001066251155	1	–
3000	•			25116	8001066251162	1	–
300		•		25131	8001066251315	1	–
500		•		25132	8001066251322	1	–
1000		•		25133	8001066251339	1	–
1500		•		25134	8001066251346	1	–
2000		•		25135	8001066251353	1	–
3000		•		25136	8001066251360	1	–
300			•	25151	8001066251513	1	–
500			•	25152	8001066251520	1	–
1000			•	25153	8001066251537	1	–
1500			•	25154	8001066251544	1	–
2000			•	25155	8001066251551	1	–
3000			•	25156	8001066251568	1	–

RIGA DA CARPENTIERE



Ref.	L mm	mm/cm	Barcode	Box	€
25200	350	mm/cm	8001066252008	1	–

- Riga rigida satinata
- **Sezione 30 x 1 mm**
- Acciaio temprato
- Graduazione incisa e annerita
- Graduazione su ambo le facce
- Graduazione mm/cm

RIGHE SPECIALI SATINATE CON GRADUAZIONE A RITIRO % PER MODELLISTI

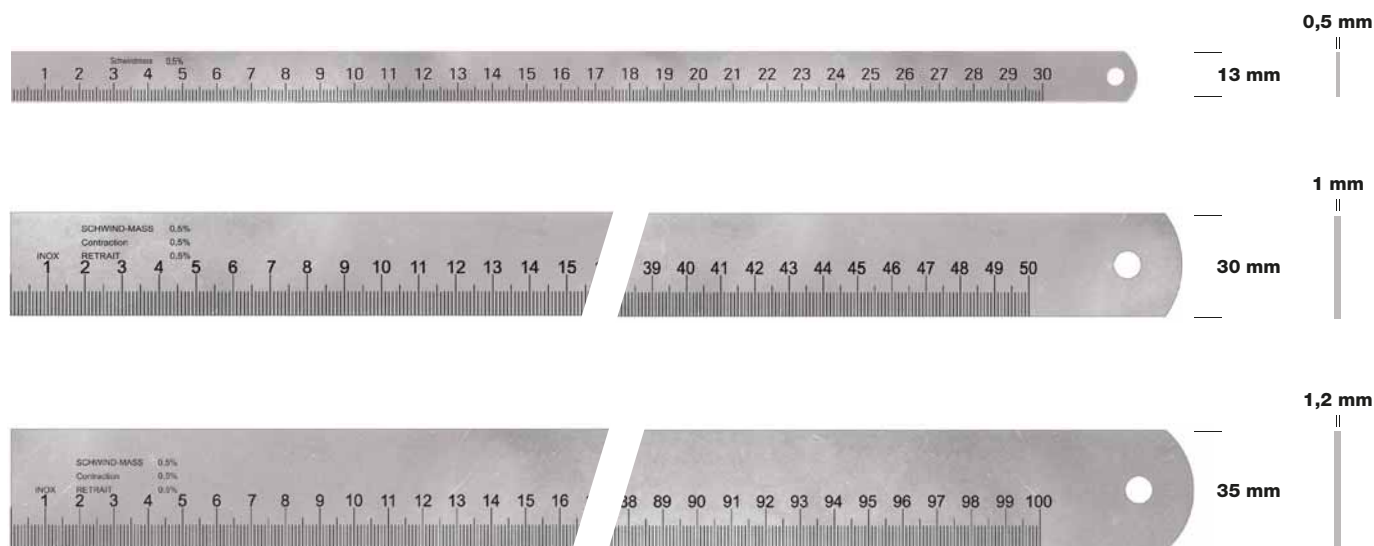

L 300 mm Sezione 13 x 0,5 mm FLESSIBILE SATINATA

Ref.	mm	%	Barcode	Box	€
24151	mm	0,5	8001066241514	1	-
24152	mm	0,8	8001066241521	1	-
24176	mm	1	8001066241767	1	-
24153	mm	1,25	8001066241538	1	-
24154	mm	1,5	8001066241545	1	-
24156	mm	1,75	8001066241569	1	-
24158	mm	2	8001066241583	1	-
24159	mm	2,25	8001066241590	1	-
24177	mm	2,5	8001066241774	1	-
24160	mm	3	8001066241606	1	-

L 500 mm Sezione 30 x 1 mm SEMIRIGIDA SATINATA

Ref.	mm	%	Barcode	Box	€
25010	mm	0,5	8001066250103	1	-
25011	mm	0,8	8001066250110	1	-
25091	mm	1	8001066250912	1	-
25012	mm	1,25	8001066250127	1	-
25013	mm	1,5	8001066250134	1	-
25015	mm	1,75	8001066250158	1	-
25017	mm	2	8001066250172	1	-
25018	mm	2,25	8001066250189	1	-
25092	mm	2,5	8001066250929	1	-
25019	mm	3	8001066250196	1	-

- Riga speciale con graduazione a ritiro %
- Riga satinata
- Acciaio inox
- Graduazione indelebile
- Bordi rettificati

L 1000 mm Sezione 35 x 1,2 mm SEMIRIGIDA SATINATA

Ref.	mm	%	Barcode	Box	€
25030	mm	0,5	8001066250301	1	-
25031	mm	0,8	8001066250318	1	-
25095	mm	1	8001066250950	1	-
25032	mm	1,25	8001066250325	1	-
25033	mm	1,5	8001066250332	1	-
25035	mm	1,75	8001066250356	1	-
25037	mm	2	8001066250370	1	-
25038	mm	2,25	8001066250387	1	-
25097	mm	2,5	8001066250974	1	-
25039	mm	3	8001066250394	1	-

L 1500 mm Sezione 35 x 1,2 mm SEMIRIGIDA SATINATA

Ref.	mm	%	Barcode	Box	€
25050	mm	0,5	8001066250509	1	-
25051	mm	0,8	8001066250516	1	-
25098	mm	1	8001066250981	1	-
25052	mm	1,25	8001066250523	1	-
25053	mm	1,5	8001066250530	1	-
25055	mm	1,75	8001066250554	1	-
25057	mm	2	8001066250578	1	-
25058	mm	2,25	8001066250585	1	-
25060	mm	2,5	8001066250608	1	-
25059	mm	3	8001066250592	1	-

L 2000 mm Sezione 35 x 1,2 mm SEMIRIGIDA SATINATA

Ref.	mm	%	Barcode	Box	€
25070	mm	0,5	8001066250707	1	-
25071	mm	0,8	8001066250714	1	-
25099	mm	1	8001066250998	1	-
25072	mm	1,25	8001066250721	1	-
25073	mm	1,5	8001066250738	1	-
25075	mm	1,75	8001066250752	1	-
25077	mm	2	8001066250776	1	-
25078	mm	2,25	8001066250783	1	-
25084	mm	2,5	8001066250844	1	-
25079	mm	3	8001066250790	1	-

TIPOMETRO A QUATTRO SCALE PER TIPOGRAFIA

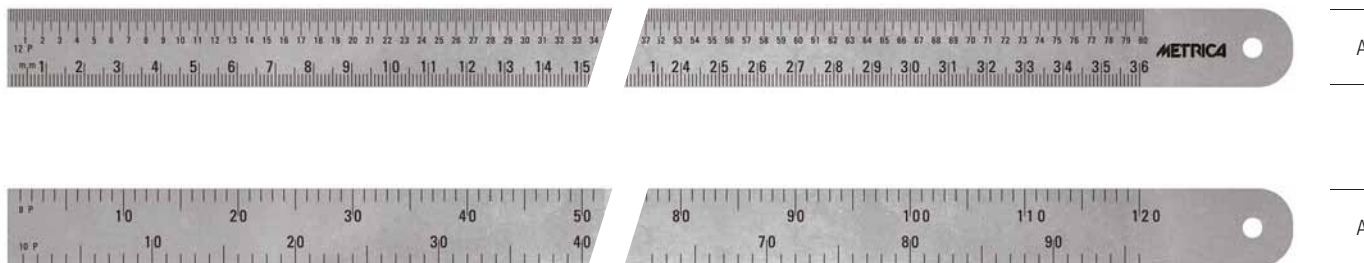

Ref.	L mm	A mm	mm	Barcode	Box	€
24122	300	20	mm	8001066241224	1	-
24123	360	20	mm	8001066241231	1	-
24124	500	20	mm	8001066241248	1	-

- Acciaio inox spessore 0,5 mm
- 4 scale per tipografia
- Graduazione indelebile su ambo i lati
- Fronte: mm e 12 pti
- Retro: 8 pti e 10 pti

RIGA RIGIDA DI CONTROLLO GRADUATA, CON SMUSSO E SENZA SMUSSO

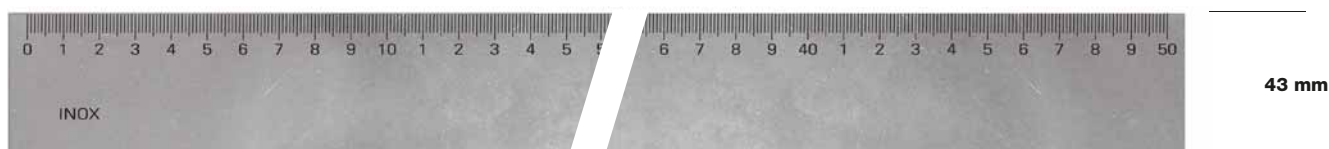

SENZA SMUSSO

Ref.	L mm	mm	Barcode	Box	€
25201	500	mm	8001066252015	1	-
25202	750	mm	8001066252023	1	-
25203	1000	mm	8001066252039	1	-
25204	1500	mm	8001066252046	1	-
25205	2000	mm	8001066252053	1	-

- Riga rigida di controllo
- Sezione 43 x 6 mm
- Acciaio inox rettificato
- Graduazione incisa e annerita
- 5 mm circa non graduati alle estremità

CON SMUSSO

Ref.	L mm	mm	Barcode	Box	€
25221	500	mm	8001066252213	1	-
25222	750	mm	8001066252220	1	-
25223	1000	mm	8001066252237	1	-
25224	1500	mm	8001066252244	1	-
25225	2000	mm	8001066252251	1	-

- Riga rigida di controllo
- Sezione 43 x 6 mm **con smusso**
- Acciaio inox rettificato
- Graduazione incisa e annerita
- 5 mm circa non graduati alle estremità



**NASTRO SPECIALE PER SCARPE
FIBRA DI VETRO**

Ref.	L mm	A mm	mm			€
70300	600	10	mm	8001066703005	10	-

- **Fibra di vetro**
- Graduazione fronte: mm
- Graduazione retro: doppia scala speciale per scarpe

**NASTRO SPECIALE PER SCARPE
ACCIAIO INOX**



Ref.	L mm	A mm	mm			€
70301	600	10	mm	8001066703012	1	-
70301V	600	10	mm	8001066703012	1	-

- **Acciaio inox temprato super flessibile**
- **Spessore 0,1 mm**
- Graduazione indelebile
- Graduazione fronte: mm
- Graduazione retro: doppia scala speciale per scarpe

Ref. **70301V**: circa 10 mm di nastro non graduato prima dello zero

RIGHE SPECIALI IN ALLUMINIO

- Lunghezza e sezioni a richiesta
- Graduazione orizzontale: sinistra-destra, destra-sinistra o con zero centrale
- Graduazione verticale: ascendente o discendente
- Nonii lineari o circolari

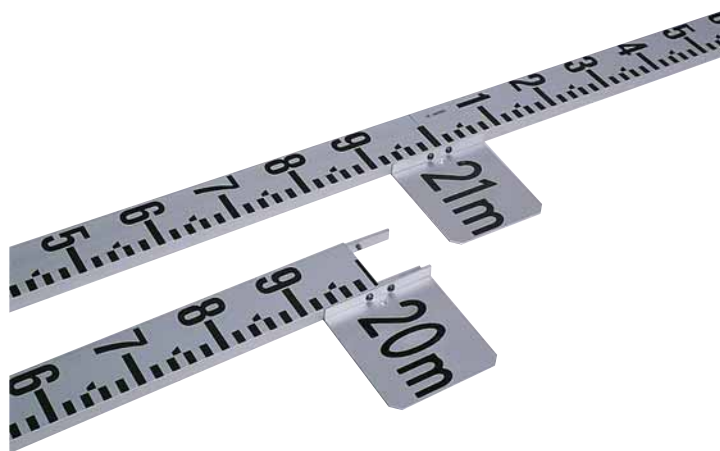

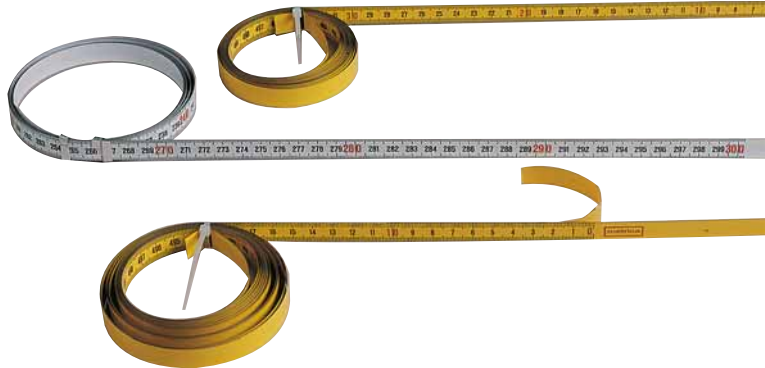

NASTRI GRADUATI PIANI ACCIAIO SMALTATO BIANCO

Ref.	L mm	mm					€
39979	2000	0 →		•	8001066399796	1	-
39980	3000	0 →		•	8001066399802	1	-
39981	5000	0 →		•	8001066399819	1	-
39985	2000	← 0		•	8001066399857	1	-
39986	3000	← 0		•	8001066399864	1	-
39987	5000	← 0		•	8001066399871	1	-
39821	2000	0 →	•		8001066398218	1	-
39822	3000	0 →	•		8001066398225	1	-
39823	5000	0 →	•		8001066398232	1	-
39826	2000	← 0	•		8001066398263	1	-
39827	3000	← 0	•		8001066398270	1	-
39828	5000	← 0	•		8001066398287	1	-

ACCIAIO SMALTATO GIALLO

Ref.	L mm	mm					€
39801	2000	0 →		•	8001066398010	1	-
39802	3000	0 →		•	8001066398027	1	-
39803	5000	0 →		•	8001066398034	1	-
39811	2000	← 0		•	8001066398119	1	-
39812	3000	← 0		•	8001066398126	1	-
39813	5000	← 0		•	8001066398133	1	-
39831	2000	0 →	•		8001066398317	1	-
39832	3000	0 →	•		8001066398324	1	-
39833	5000	0 →	•		8001066398331	1	-
39836	2000	← 0	•		8001066398362	1	-
39837	3000	← 0	•		8001066398379	1	-
39838	5000	← 0	•		8001066398386	1	-



- Nastro graduato in acciaio smaltato bianco o giallo
- Sezione 13 x 0,2 mm
- Decimali rossi
- Con o senza biadesivo
- Larghezza 16 mm a richiesta
- Lunghezza e graduazioni a richiesta

- con biadesivo
- senza biadesivo
- graduazione orizzontale sinistra-destra
- graduazione orizzontale destra-sinistra

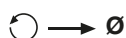

DIAMETROMETRO RAPIDO



Ref.	∅ mm	∅ mm	A x B mm			€
25497	15 ÷ 115	45 ÷ 362	8 x 0,10	8001066254972	1	-
25498	100 ÷ 320	315 ÷ 1000	13 x 0,10	8001066254989	1	-

- Per **misure rapide** e dirette **del diametro**
- Senza finestrella per rientro del nastro
- Spessore 0,10 mm
- **Acciaio inox**
- Lettura **nonio 0,1 mm**
- Graduazione indelebile

DIAMETROMETRO



Ref.	∅ mm	∅ mm	A x B mm			€
25510	20 ÷ 300	60 ÷ 950	15 x 0,50	8001066255108	1	-
25511	300 ÷ 700	940 ÷ 2200	15 x 0,50	8001066255115	1	-
25512	700 ÷ 1100	2190 ÷ 3460	15 x 0,50	8001066255122	1	-
25513	1100 ÷ 1500	3450 ÷ 4720	15 x 0,50	8001066255139	1	-
25514	1500 ÷ 1900	4710 ÷ 5980	15 x 0,50	8001066255146	1	-
25515	1900 ÷ 2300	5960 ÷ 7230	15 x 0,50	8001066255153	1	-
25516	2000 ÷ 3000	6280 ÷ 9420	15 x 0,50	8001066255160	1	-

- Riga flessibile graduata per **lettura diretta del diametro**
- **Acciaio inox**
- Graduazione indelebile
- Lettura **nonio 0,1 mm**
- Con finestrella per rientro del nastro
- Sezione 15 x 0,5 mm



Ref. 38911



Ref. 38910

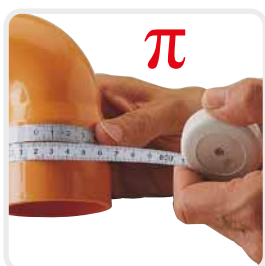

DIAMETROMETRI

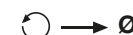

Ref.	L					€
38910	2 m	10 mm	mm π / mm	8001066389100	12	-
38911	2 m	6 mm	mm π / mm	8001066389117	12	-

- Cassa in ABS resistente agli urti
- Rientro automatico del nastro
- Doppia graduazione:
 - **avanti mm**;
 - **retro π** (lettura diretta del diametro)

Ref. 38910: Nastro piano **largo 10 mm**, laccato bianco

Ref. 38911: Nastro piano **largo 6 mm** superflessibile, laccato nero

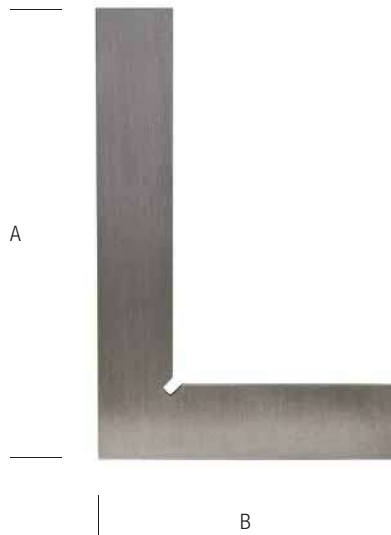

SQUADRA SEMPLICE TEMPRATA

Ref.	A x B mm			€
26031	50 x 40	8001066260317	1	–
26032	75 x 50	8001066260324	1	–
26033	100 x 70	8001066260331	1	–
26035	150 x 100	8001066260355	1	–
26036	200 x 130	8001066260362	1	–
26038	300 x 200	8001066260386	1	–

- Acciaio **inox temprato**
- Precisione DIN 875/0

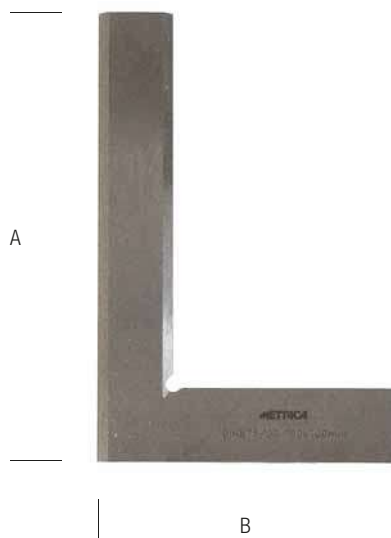

SQUADRA BISELLATA TEMPRATA

Ref.	A x B mm			€
27029	25 x 20	8001066270293	1	–
27030	40 x 28	8001066270309	1	–
27031	50 x 40	8001066270316	1	–
27032	75 x 50	8001066270323	1	–
27033	100 x 70	8001066270330	1	–
27035	150 x 100	8001066270354	1	–
27036	200 x 130	8001066270361	1	–
27038	300 x 200	8001066270385	1	–

- Acciaio **inox temprato**
- Precisione DIN 875/0



SQUADRA A CAPPELLO TEMPRATA

Ref.	A x B mm			€
27071	50 x 40	8001066270712	1	–
27072	75 x 50	8001066270729	1	–
27073	100 x 70	8001066270736	1	–
27075	150 x 100	8001066270750	1	–
27076	200 x 130	8001066270767	1	–
27078	300 x 200	8001066270781	1	–

- Acciaio **inox temprato**
- Precisione DIN 875/0

SQUADRA SEMPLICE



Ref.	A x B mm			€
PRECISIONE 1/100 mm				
29053	100 x 70	8001066290536	1	–
29055	150 x 100	8001066290550	1	–
29056	200 x 130	8001066290567	1	–
29057	250 x 165	8001066290574	1	–
29058	300 x 200	8001066290581	1	–
29059	400 x 265	8001066290598	1	–
29060	500 x 330	8001066290604	1	–
29061	600 x 400	8001066290611	1	–
29062	750 x 500	8001066290628	1	–
29063	1000 x 600	8001066290635	1	–
PRECISIONE 1/50 mm				
29072	75 x 50	8001066290727	1	–
29073	100 x 70	8001066290734	1	–
29075	150 x 100	8001066290758	1	–
29076	200 x 130	8001066290765	1	–
29077	250 x 165	8001066290772	1	–
29078	300 x 200	8001066290789	1	–
29079	400 x 250	8001066290796	1	–
29080	500 x 330	8001066290802	1	–

- Acciaio normale rettificato **non temprato**
- Sezione robusta

SQUADRA A CAPPELLO



Ref.	A x B mm			€
PRECISIONE 1/100 mm				
29143	100 x 70	8001066291434	1	–
29145	150 x 100	8001066291458	1	–
29146	200 x 130	8001066291465	1	–
29147	250 x 165	8001066291472	1	–
29148	300 x 200	8001066291489	1	–
29149	400 x 265	8001066291496	1	–
29150	500 x 330	8001066291502	1	–
29151	600 x 400	8001066291519	1	–
29152	750 x 500	8001066291526	1	–
29153	1000 x 600	8001066291533	1	–
PRECISIONE 1/50 mm				
29162	75 x 50	8001066291625	1	–
29163	100 x 70	8001066291632	1	–
29165	150 x 100	8001066291656	1	–
29166	200 x 130	8001066291663	1	–
29167	250 x 165	8001066291670	1	–
29168	300 x 200	8001066291687	1	–
29169	400 x 250	8001066291694	1	–
29170	500 x 330	8001066291700	1	–

- Acciaio normale rettificato **non temprato**
- Sezione robusta



SQUADRA SEMPLICE IN ACCIAIO ZINCATO

Ref.	A x B mm			€
29182	100 x 70	8001066291823	1	—
29183	150 x 100	8001066291830	1	—
29184	200 x 130	8001066291847	1	—
29185	250 x 165	8001066291854	1	—
29186	300 x 200	8001066291861	1	—
29187	400 x 250	8001066291878	1	—
29188	500 x 330	8001066291885	1	—
29189	600 x 400	8001066291892	1	—
29190	800 x 400	8001066291908	1	—
29191	1000 x 500	8001066291915	1	—

■ Acciaio normale **non temprato** con **zincatura** di protezione

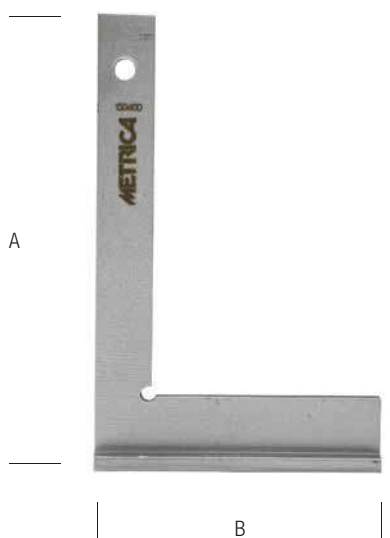

SQUADRA A CAPPELLO IN ACCIAIO ZINCATO

Ref.	A x B mm			€
29192	100 x 70	8001066291922	1	—
29193	150 x 100	8001066291939	1	—
29194	200 x 130	8001066291946	1	—
29195	250 x 165	8001066291953	1	—
29196	300 x 200	8001066291960	1	—
29197	400 x 250	8001066291977	1	—
29198	500 x 330	8001066291984	1	—
29199	600 x 400	8001066291991	1	—
29200	800 x 400	8001066292004	1	—
29210	1000 x 500	8001066292103	1	—

■ Acciaio normale **non temprato** con **zincatura** di protezione





RIGA A BATTENTE PER TRACCIARE

Ref.	L mm			€
29263	200	8001066292639	1	—
29264	250	8001066292646	1	—
29265	300	8001066292653	1	—

- In acciaio
- Lettura 0,1 mm
- Scala graduata incisa
- Vite di bloccaggio



PROFILOMETRO PROFESSIONALE

Ref.	A mm	B mm			€
72003	150	85	8001066720033	1	-
72002	300	150	8001066720026	1	-

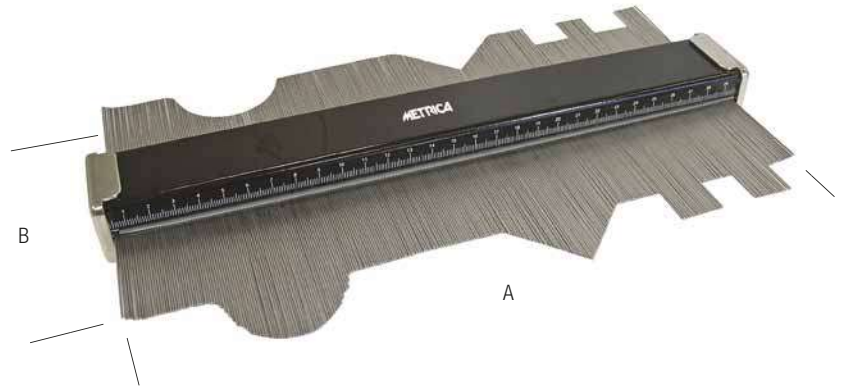
- Modello **professionale** per rilievo sagome o profili
- Aghi mobili
- **Acciaio temprato**





PROFILOMETRO

Ref.	A mm	B mm			€
72001	150	85	8001066720019	1	-

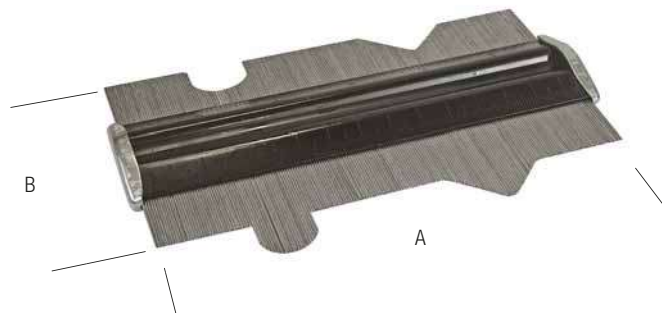
- Per rilievo sagome o profili
- Aghi mobili
- Acciaio
- Fornito in blister



PROFILOMETRO ANTIGRAFFIO

Ref.	A mm	B mm			€
72005	250	95	8001066720057	1	-

- Per rilievo sagome o profili
- Aghi mobili
- Plastica antigraffio
- Fornito in blister

Non in vendita in U.K.

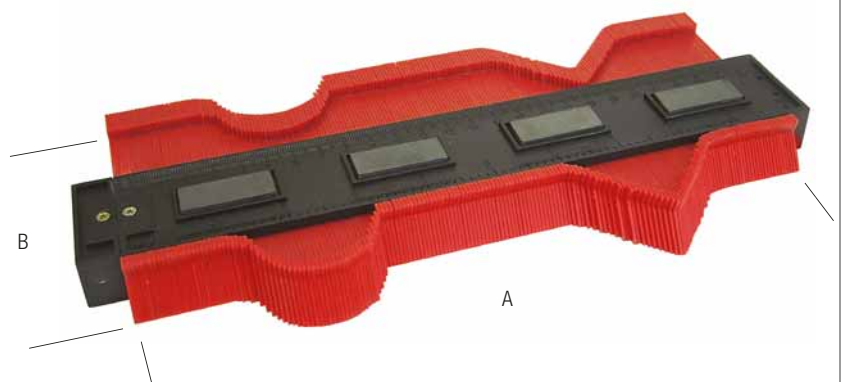



COMPASSO A MOLLA

Ref.	L mm			€	Ref.			€
48011	100	8001066480111	2	-	08011	8001066080113	5	-
48012	125	8001066480128	2	-	-	-	-	-
48013	150	8001066480135	2	-	08013	8001066080137	5	-
48014	175	8001066480142	2	-	-	-	-	-
48015	200	8001066480159	2	-	08015	8001066080151	5	-
48016	250	8001066480166	2	-	-	-	-	-
48017	300	8001066480173	2	-	-	-	-	-

- Compasso a molla
- Apertura rapida
- Serie pesante a **sezione quadrata**
- **Punte in acciaio temprato**

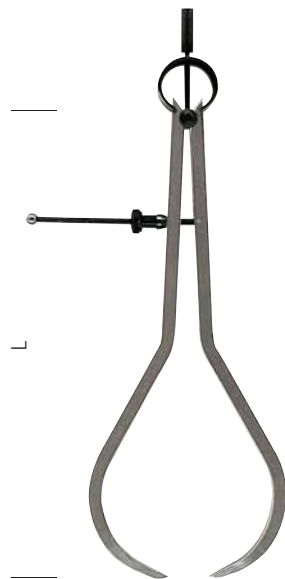

COMPASSO A MOLLA PER ESTERNI

Ref.	L mm			€	Ref.			€
48021	100	8001066480210	2	-	08021	8001066080212	5	-
48022	125	8001066480227	2	-	-	-	-	-
48023	150	8001066480234	2	-	06023	8001066060238	5	-
48024	175	8001066480241	2	-	-	-	-	-
48025	200	8001066480258	2	-	06025	8001066060252	5	-
48026	250	8001066480265	2	-	-	-	-	-
48027	300	8001066480272	2	-	-	-	-	-

- Compasso a molla **per esterni**
- Apertura rapida
- Serie pesante a **sezione quadrata**
- **Punte in acciaio temprato**

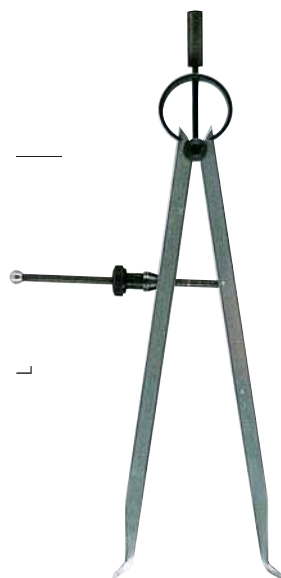

COMPASSO A MOLLA PER INTERNI

Ref.	L mm			€	Ref.			€
48031	100	8001066480319	2	-	-	-	-	-
48032	125	8001066480326	2	-	-	-	-	-
48033	150	8001066480333	2	-	08033	8001066080335	5	-
48034	175	8001066480340	2	-	-	-	-	-
48035	200	8001066480357	2	-	-	-	-	-
48036	250	8001066480364	2	-	-	-	-	-
48037	300	8001066480371	2	-	-	-	-	-

- Compasso a molla **per interni**
- Apertura rapida
- Serie pesante a **sezione quadrata**
- **Punte in acciaio temprato**



COMPASSO A SETTORE



Ref.	L mm			€	Ref.			€
48053	150	8001066480531	2	–	08053	8001066080533	5	–
48055	200	8001066480555	2	–	08055	8001066080557	5	–
48056	250	8001066480562	2	–	08056	8001066080564	5	–
48057	300	8001066480579	2	–	–	–	–	–
48058	400	8001066480586	1	–	–	–	–	–
48059	500	8001066480593	1	–	–	–	–	–
48066	600	8001066480661	1	–	–	–	–	–
48068	800	8001066480685	1	–	–	–	–	–
48069	1000	8001066480692	1	–	–	–	–	–

- **Compasso a settore**
- Serie pesante a sezione quadrata
- **Punte in acciaio temprato**
- Con **guide e bloccaggio**



COMPASSO A CERNIERA CON SUPPORTO



Ref.	L mm			€
48075	150	8001066480753	2	–
48076	200	8001066480760	2	–
48077	300	8001066480777	2	–
48078	500	8001066480784	1	–

- Compasso a cerniera
- **Con supporto per matita**
- In acciaio
- Sezione pesante
- In astuccio di plastica



COMPASSO SEMPLICE



Ref.	L mm			€
48002	150	8001066480029	2	–
48003	200	8001066480036	2	–
48004	250	8001066480043	2	–
48005	300	8001066480050	2	–
48006	500	8001066480067	1	–
48007	600	8001066480074	1	–
48008	800	8001066480081	1	–
48009	1000	8001066480098	1	–

- Compasso semplice
- Punte diritte in acciaio temprato
- **Sezione quadrata**
- Snodo di articolazione con rivetto
- Esecuzione robusta



PUNTA A TRACCIARE

Ref.	L mm			€
08145	190	8001066081455	5	-



- Punta a tracciare
- Acciaio temprato e brunito
- Punta diritta e piegata
- In blister



PUNTA A TRACCIARE TASCABILE ORIGINALE RICO

Ref.	L mm			€
28146	170	8001066281466	1	-



- Punta a tracciare tascabile
- Punta in metallo duro
- Formato penna
- Con clip
- Originale "RICO"

RICAMBI

Punta RICO	Ref.			€
	28152	8001066281527	1	-

PUNTA A TRACCIARE TASCABILE - METAL

Ref.	L mm			€
08150	150	8001066081509	5	-



- Punta a tracciare tascabile
- Punta in metallo duro
- **Corpo in metallo**
- Formato penna
- Con clip
- In blister

RICAMBI

Punta	Ref.			€
	28151	8001066281510	2	-

BULINO

Ref.	L mm			€
00170	125	8001066001705	5	-

- Bulino 125 mm
- Black finishing



TRUSCHINO SEMPLICE

Ref.	L mm			€
45011	0 - 300	8001066450114	1	-

- Truschino semplice
- Asta incernierata
- Bloccaggio a ghiera
- Punta a tracciare
- Base prismatica



TRUSCHINO GRADUATO DI PRECISIONE

Ref.	A mm				€
45050	0 - 300	0,02	8001066450503	1	-
45051	0 - 500	0,02	8001066450510	1	-

- Truschino graduato di precisione
- Inox temprato
- Punta a tracciare in metallo duro
- Scala cromata
- Vite micrometrica
- Base prismatica
- Astuccio in legno

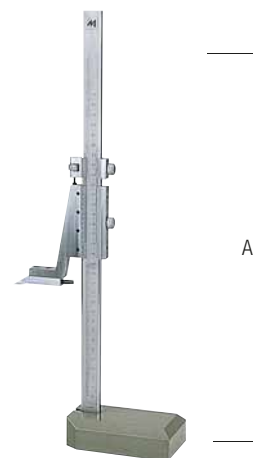

TRUSCHINO DIGITALE

Ref.	A mm				€
45070	0 - 300	0,01	8001066450701	1	-
45071	0 - 500	0,01	8001066450718	1	-
45072	0 - 1000	0,01	8001066450725	1	-

- Truschino digitale
- Acciaio inox temprato
- Vite micrometrica di regolazione fine
- Lettura 0,01 mm
- Azzeramento per misure comparative
- Conversione mm/inch
- Punta a tracciare in metallo duro
- Astuccio in legno

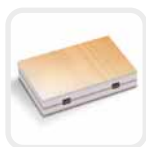

TRUSCHINO CON COMPARATORE

Ref.	A mm				€
45060	0 - 300	0,01	8001066450602	1	-
45061	0 - 600	0,01	8001066450619	1	-

- Truschino con comparatore
- 2 colonne di scorrimento
- Movimento a cremagliera azionato da volantino
- Doppio contatore a mm (ascendente, discendente)
- Lettura su contatore: 1 mm
- Lettura su comparatore: 0,01 mm
- Punta a tracciare in metallo duro
- Astuccio in legno





A

LIVELLA LINEARE DI PRECISIONE IN GHISA

Ref.	A mm	$\frac{1}{1000}$ mm			€
30010	150	0,02	8001066300105	1	—
30011	150	0,05	8001066300112	1	—
30012	150	0,10	8001066300129	1	—
30013	150	0,35	8001066300136	1	—
30020	200	0,02	8001066300204	1	—
30021	200	0,05	8001066300211	1	—
30022	200	0,10	8001066300228	1	—
30023	200	0,35	8001066300235	1	—
30030	250	0,02	8001066300303	1	—
30031	250	0,05	8001066300310	1	—
30032	250	0,10	8001066300327	1	—
30033	250	0,35	8001066300334	1	—
30040	300	0,02	8001066300402	1	—
30041	300	0,05	8001066300419	1	—
30042	300	0,10	8001066300426	1	—
30043	300	0,35	8001066300433	1	—

- In ghisa
- 2 file
- Base prismatica
- Astuccio in legno

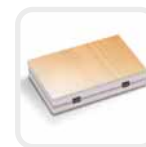

LIVELLA LINEARE DI PRECISIONE IN GHISA

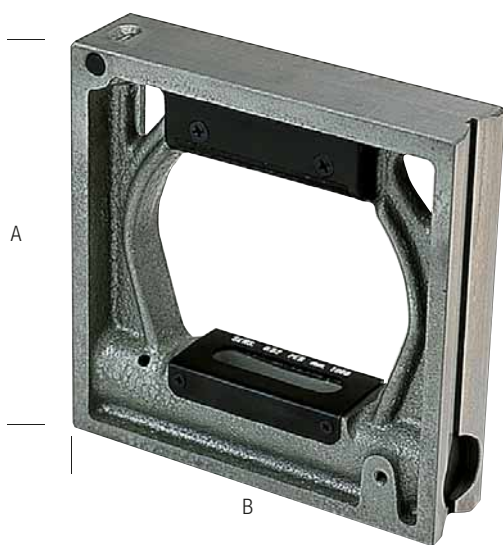

A

B

Ref.	A x B mm	$\frac{1}{1000}$ mm			€
30101	100 x 100	0,02	8001066301010	1	—
30102	100 x 100	0,10	8001066301027	1	—
30103	100 x 100	0,35	8001066301034	1	—
30110	150 x 150	0,02	8001066301102	1	—
30111	150 x 150	0,05	8001066301119	1	—
30112	150 x 150	0,10	8001066301126	1	—
30113	150 x 150	0,35	8001066301133	1	—
30120	200 x 200	0,02	8001066301201	1	—
30121	200 x 200	0,05	8001066301218	1	—
30122	200 x 200	0,10	8001066301225	1	—
30123	200 x 200	0,35	8001066301232	1	—
30130	250 x 250	0,02	8001066301300	1	—
30131	250 x 250	0,05	8001066301317	1	—
30132	250 x 250	0,10	8001066301324	1	—

- In ghisa
- 2 lati prismatici
- Astuccio in legno



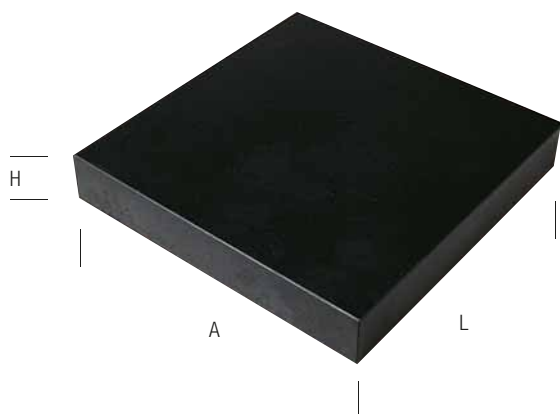



 Precisione:

DIN/0 Superficie lappata

DIN/I Superficie finemente raschiata

PIANO DI RISCONTRO IN DIABASE

Ref.	A mm	L mm	H mm				€
28101	400	250	60	DIN/0	8001066281015	1	–
28102	500	315	70	DIN/0	8001066281022	1	–
28103	630	400	80	DIN/0	8001066281039	1	–
28104	800	500	100	DIN/0	8001066281046	1	–
28105	800	800	120	DIN/0	8001066281053	1	–
28106	1000	630	140	DIN/0	8001066281060	1	–

28090	250	160	40	DIN/I	8001066280902	1	–
28091	400	250	60	DIN/I	8001066280919	1	–
28092	500	315	70	DIN/I	8001066280926	1	–
28093	630	400	80	DIN/I	8001066280933	1	–
28094	800	500	100	DIN/I	8001066280940	1	–
28095	800	800	120	DIN/I	8001066280957	1	–
28096	1000	630	140	DIN/I	8001066280964	1	–

■ Tavolo a richiesta

PIANO DI RISCONTRO IN GHISA





 Precisione:

DIN/I Superficie finemente raschiata

DIN/II Superficie raschiata

• Superficie piattata

Ref.	A mm	L mm				€
28115	200	300	DIN/I	8001066281152	1	–
28116	300	400	DIN/I	8001066281169	1	–
28117	300	500	DIN/I	8001066281172	1	–
28118	400	500	DIN/I	8001066281189	1	–
28119	400	600	DIN/I	8001066281190	1	–
28120	500	600	DIN/I	8001066281206	1	–
28121	500	800	DIN/I	8001066281213	1	–
28122	500	1000	DIN/I	8001066281220	1	–
28124	800	1200	DIN/I	8001066281244	1	–
28125	1000	1200	DIN/I	8001066281251	1	–

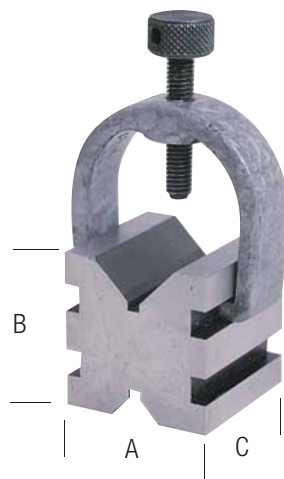

28170	200	300	DIN/II	8001066281701	1	–
28171	300	400	DIN/II	8001066281718	1	–
28172	300	500	DIN/II	8001066281725	1	–
28173	400	500	DIN/II	8001066281732	1	–
28174	400	600	DIN/II	8001066281749	1	–
28175	500	600	DIN/II	8001066281756	1	–
28176	500	800	DIN/II	8001066281763	1	–
28177	500	1000	DIN/II	8001066281770	1	–
28178	800	1200	DIN/II	8001066281787	1	–
28179	1000	1200	DIN/II	8001066281794	1	–

■ Tavolo a richiesta



 Precisione:
DIN/I Superficie finemente raschiata

PRISMA IN ACCIAIO TEMPRATO

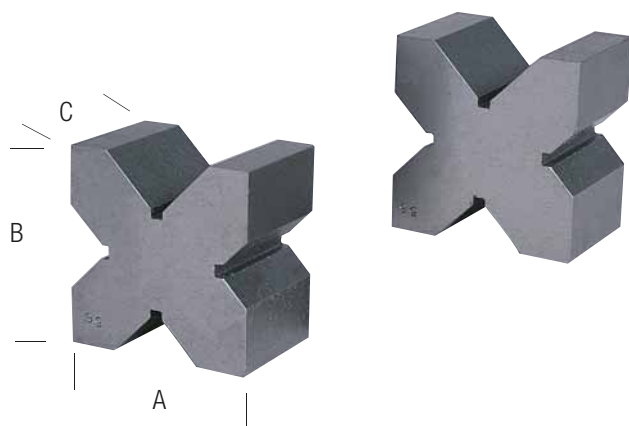

Ref.	A mm	B mm	C mm				€
28135	36	40	45	DIN/I	8001066281350	1	–
28137	45	63	70	DIN/I	8001066281374	1	–
28138	70	90	125	DIN/I	8001066281381	1	–

- Prisma con morsetto
- Acciaio temprato
- Per controlli e tracciature di precisione
- 2 scanalature a 90°
- Fornito singolarmente



 Precisione:
DIN/I Superficie finemente raschiata
DIN/II Superficie raschiata

COPPIA DI PRISMI PARALLELI A CROCE IN GHISA



Ref.	A mm	L mm	H mm				€
28128	42	42	50	DIN/I	8001066281282	1	–
28129	60	60	50	DIN/I	8001066281299	1	–
28130	75	75	50	DIN/I	8001066281305	1	–
28131	90	90	50	DIN/I	8001066281312	1	–
28132	100	80	50	DIN/I	8001066281329	1	–
28133	120	90	60	DIN/I	8001066281336	1	–

28139	42	42	50	DIN/II	8001066281398	1	–
28140	60	60	50	DIN/II	8001066281404	1	–
28141	75	75	50	DIN/II	8001066281411	1	–
28142	90	90	50	DIN/II	8001066281428	1	–
28143	100	80	50	DIN/II	8001066281435	1	–
28144	120	90	60	DIN/II	8001066281442	1	–

- Prismi paralleli a croce
- In ghisa
- Rettificati in coppia
- Forniti in coppia



GUARDAPIANO INOX

Ref.	A mm			€
28021	75	8001066280216	1	–
28022	100	8001066280223	1	–
28023	125	8001066280230	1	–
28024	150	8001066280247	1	–
28025	200	8001066280254	1	–
28027	300	8001066280278	1	–
28028	400	8001066280285	1	–
28029	500	8001066280292	1	–
28030	600	8001066280308	1	–
28031	800	8001066280315	1	–
28032	1000	8001066280322	1	–

- Acciaio **inox temprato**
- Con impugnatura isolante
- In astuccio
- precisione DIN 874

INOX



BASE MAGNETICA

Ref.	H mm				€
46010	230	60 Kg	8001066460106	1	-
46015	230	45 Kg	8001066460151	1	-

- 3 bracci di sezione robusta
- Con registrazione per piccoli aggiustamenti
- Base prismatica
- Interruttore a leva
- Portata 45/60 Kg
- Fornita senza comparatore

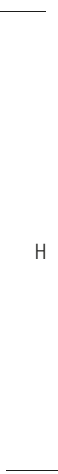

BASE MAGNETICA UNIVERSALE A BRACCI

Ref.	H mm				€
46025	410	80 Kg	8001066460250	1	-

- Bracci snodati di sezione molto robusta
- Bloccaggio in qualunque posizione
- Base prismatica
- Interruttore a leva
- Portata 80 Kg



BASE MAGNETICA SNODATA

Ref.	H mm				€
46020	370	45 Kg	8001066460205	1	-

- Tipo snodabile
- Bloccaggio in qualunque posizione
- Base prismatica
- Interruttore a leva
- Portata 45 Kg

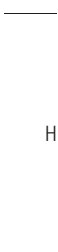

MINI BASE MAGNETICA

Ref.	H mm				€
46023	100	10 Kg	8001066460236	1	-

- Base cilindrica di piccolo ingombro
- Ø 25 mm
- Altezza 100 mm
- Portata 10 Kg

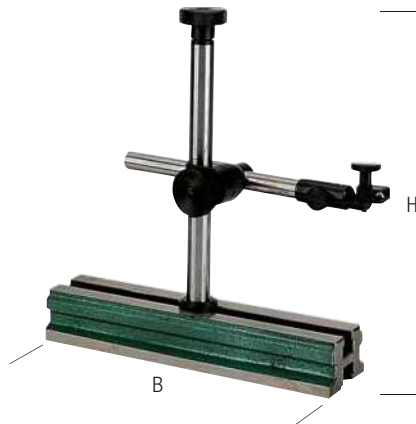

SUPPORTO UNIVERSALE

Ref.	H mm	B mm			€
46005	300	250	8001066460052	1	-

- Supporto universale
- Base prismatica rettificata
- Con vite di regolazione

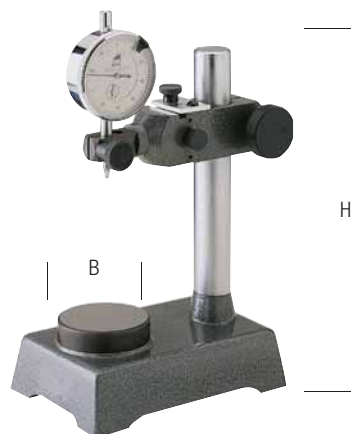

SUPPORTO A COLONNA DI PRECISIONE

Ref.	H mm	B mm			€
46060	290	60	8001066460601	1	-

- Acciaio temprato e rettificato
- Regolazione fine del comparatore
- Fornito senza comparatore
- Astuccio in legno



SUPPORTO PER MICROMETRI

Ref.	H mm	B mm			€
46070	-	-	8001066460700	1	-

- Supporto per micrometri
- Morsetto regolabile

SUPPORTO MAGNETICO

Ref.	inch	A x A mm			€
60300	3"	85 x 85	8001066603008	1	-
60304	4"	110 x 110	8001066603004	1	-
60305	5"	135 x 135	8001066603005	1	-

- Supporto magnetico
- Multifunzione: per saldare, assemblare, fissare
- Magnetico su tutti i lati del contorno



PUNZONI PROFESSIONALI SERIE ALFABETO

Ref.	H mm			€
70133	3	8001066701339	1	–
70134	4	8001066701346	1	–
70135	5	8001066701353	1	–
70136	6	8001066701360	1	–
70137	8	8001066701377	1	–

- Punzoni **professionali** serie alfabeto, 27 lettere
- Acciaio temprato
- Qualità extra: Cr-V (6150)

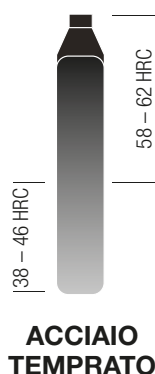

PUNZONI PROFESSIONALI SERIE NUMERI

Ref.	H mm			€
70143	3	8001066701438	1	–
70144	4	8001066701445	1	–
70145	5	8001066701452	1	–
70146	6	8001066701469	1	–
70147	8	8001066701476	1	–

- Punzoni **professionali** serie numeri, 9 cifre
- Acciaio temprato
- Qualità extra Cr-V (6150)



PUNZONI SERIE ALFABETO

Ref.	H mm			€
70102	2	8001066701025	1	–
70104	3	8001066701049	1	–
70105	4	8001066701056	1	–
70106	5	8001066701063	1	–
70107	6	8001066701070	1	–
70108	8	8001066701087	1	–
70109	10	8001066701094	1	–

- Punzoni serie alfabeto, 27 lettere



PUNZONI SERIE NUMERI

Ref.	H mm			€
70152	2	8001066701520	1	–
70154	3	8001066701544	1	–
70155	4	8001066701551	1	–
70156	5	8001066701568	1	–
70157	6	8001066701575	1	–
70158	8	8001066701582	1	–
70159	10	8001066701599	1	–

- Punzoni serie numeri, 9 cifre





CONTATUTTO MANUALE TASCABILE 4 CIFRE (9999)

Ref.	H mm	∅ mm			€
65043	3,5	43	8001066650439	1	—
65044	3,5	43	8001066650446	1	—

- Altezza cifre 3,5 mm
- Rimessa a zero
- Velocità max 500 colpi/minuto
- Peso 60 gr

CONTACOLPI A 5 CIFRE (99999)



Ref.	H mm						€
65055	5		•	y	8001066650552	1	—
65056	5		•	x	8001066650569	1	—
65057	5	•		y	8001066650576	1	—
65058	5	•		x	8001066650583	1	—

- Altezza cifre 5 mm
- Rimessa a zero con bottone rotativo
- Velocità max 1000 colpi/minuto
- Peso 50 gr
- Corpo in materiale sintetico
- Esecuzione impermeabile
- Eventuale base di fissaggio a richiesta

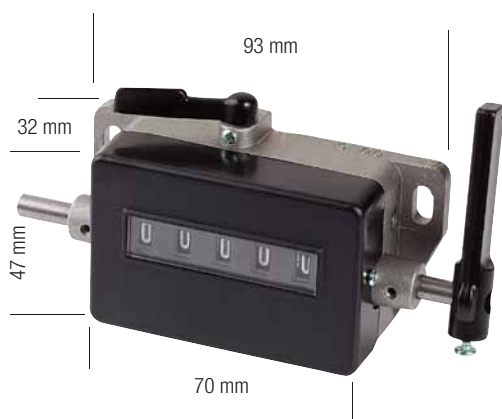

CONTACOLPI A 5 CIFRE (99999)

Ref.	H mm						€
65060	6	•	•	y	8001066650606	1	—
65061	6	•	•	x	8001066650613	1	—

- Altezza cifre 6 mm
- Uscita albero destra e sinistra
- Rimessa a zero rapida
- Velocità max 700 colpi/minuto
- Peso 360 gr
- Corpo in zama
- Esecuzione robusta per applicazione su macchine



CONTAGIRI A 4 CIFRE (9999)

Ref.	H mm						€
70000	6		•	x/y	8001066700004	1	—

- Rotazione in entrambi i sensi
- Rimessa a zero
- Velocità max 5000 giri/minuto
- Peso 160 gr
- Puntale in gomma + un puntale di ricambio

CONTAGIRI A 5 CIFRE (99999)

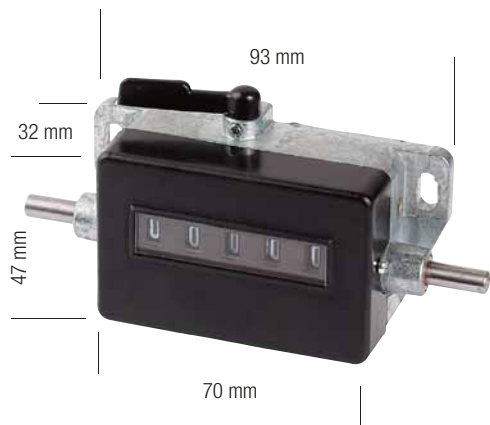

Ref.	H mm	□	□	x	y	Barcode	Box	€
70003	6	•	•	y		8001066700035	1	–
70005	6	•	•	x		8001066700059	1	–

- Altezza cifre 6 mm
- Uscita albero destra e sinistra
- Rimessa a zero
- Velocità max 5000 giri/minuto
- Peso 360 gr
- Corpo in zama
- Esecuzione robusta per applicazione su macchine

CONTAMETRO A 5 CIFRE (9999,9)



1/1 (1 giro = 10 cm)

Ref.	H mm	□	□	x	y	Barcode	Box	€
65110	5		•	y/x		8001066651108	1	–
65112	5	•		y/x		8001066651122	1	–

- Rotazione incrementale in entrambi i sensi
- Decimale rosso
- Altezza cifre 5 mm
- Rimessa a zero
- Velocità: 500m/minuto
- Base di fissaggio a richiesta
- Peso: gr. 50

Adatto per ruote sviluppo 10 cm (Ref. 65020 e 65021)

CONTAMETRO A 5 CIFRE (9999,9)



1/1 (1 giro = 10 cm)

Ref.	H mm	□	□	x	y	Barcode	Box	€
65000	6	•	•	y		8001066650002	1	–
65002	6	•	•	x		8001066650026	1	–

1/2 (1 giro = 20 cm)

Ref.	H mm	□	□	x	y	Barcode	Box	€
65003	6	•	•	y		8001066650033	1	–
65004	6	•	•	x		8001066650040	1	–

- Decimale rosso
- Altezza cifre 6 mm
- Rimessa a zero rapida
- Velocità: 500m/minuto
- Esecuzione robusta per applicazione su macchine
- Corpo in zama
- Peso: 360 gr

Ref. 65000 e 65002 adatti per ruote sviluppo 10 cm (Ref. 65020 e 65021)

Ref. 65003 e 65004 adatti per ruote sviluppo 20 cm (Ref. 65022)

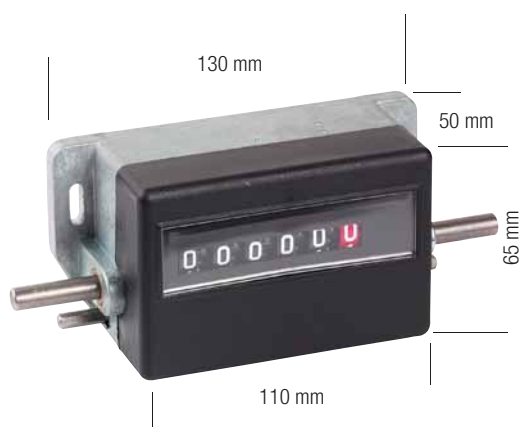

Adatto per ruote sviluppo 50 cm (Ref. **65024**)

CONTAMETRO A 6 CIFRE (99999,9)

1/5 (1 giro = 50 cm)

Ref.	H mm					€
65007	8	•	y	8001066650071	1	-
65008	8	•	x	8001066650088	1	-

- Decimale rosso
- Altezza cifre 8 mm
- Rimessa a zero rapida
- Velocità: 500 m/minuto
- Esecuzione robusta per applicazione su macchine
- Corpo in zama
- Peso: 800 gr



Ref. **65030**

Ref. **65035**

Adatto per ruote sviluppo 20 cm (Ref. **65022**)

CONTAMETRI COMPLETI A 4 CIFRE (999,9)

1/2 (1 giro = 20 cm)

Ref.	H mm					€
65030	6	•	y	8001066650309	1	-
65031	6	•	x	8001066650316	1	-

- Decontometri
- 4 cifre
- Doppio display
- Ruota a gola (20 cm) per filati/corde
- Tasto di riprenotazione numero predisposto
- Intervento elettrico sullo "0"

1/2 (1 giro = 20 cm)

Ref.	H mm					€
65035	6	•	y	8001066650354	1	-

- Contametri
- Per cavi/corde Ø 2,5 ÷ 9 mm
- Tasto di azzeramento rapido



Ref. **65020**

Ref. **65021**

Ref. **65022**

Ref. **65024**

RUOTE DI MISURA

Ref.	S mm					€
65020	100	A	7	8001066650200	1	-
65021	100	B	18	8001066650217	1	-
65022	200	C	34	8001066650224	1	-
65024	500	D	375	8001066650248	1	-

- A = Moplen + OR
- B = Alluminio zigrinato
- C = Moplen + gomma
- D = Alluminio + fascia gommata

Ref.	pag.	Ref.	pag.	Ref.	pag.	Ref.	pag.
00002	200	08010	128	08496	106	08973	96
00011	209	08011	246	08497	106	08974	96
00038	207	08012	128	08503	101	08975	96
00039	207	08013	246	08505	101	08978	96
00045	186	08015	246	08508	101	09010	128
00170	248	08020	128	08510	101	09012	170
00250	47	08021	246	08593	103	09014	168
00500	174	08030	128	08595	103	09017	168
00503	174	08033	246	08596	103	09018	171
00722	208	08053	247	08597	97	09022	169
00801	209	08055	247	08598	103	09023	171
01089	183	08056	247	08599	103	09026	167
01090	183	08075	95	08643H	104	09028	167
02040	137	08078	95	08645H	104	09029	167
03080	133	08103	94	08646H	104	09035	170
03081	161	08104	94	08647H	104	09040	132
03083	161	08105	94	08648H	104	09043	132
03084	161	08108	94	08653	104	09045	172
03090	133	08143	94	08654	104	09050	132
03093	133	08144	94	08655	104	09052	173
03130	134	08145	248	08656	104	09053	173
03140	134	08148	94	08658	104	09056	170
03150	134	08150	248	08660	104	09060	132
03160	134	08162	106	08665	100	09102	168
03169	135	08163	106	08755	98	09103	169
04030	163	08165	106	08758	98	09104	171
05020	216	08182	106	08765	98	09105	172
05021	216	08183	106	08768	98	09106	172
05022	216	08185	106	08793	102	09117	172
05023	216	08196	106	08794	102	09119	170
05024	216	08206	105	08795	102	09121	171
05041	216	08212	96	08798	102	09130	169
05042	216	08214	96	08800	102	09145	173
05043	216	08215	96	08892	107	09242	144
05100	216	08218	96	08893	107	09243	144
05101	216	08264	105	08895	107	09244	144
05102	216	08320	99	08912	107	09245	144
05103	216	08321	99	08913	107	09247	144
05104	216	08322	99	08915	107	09498	180
05105	216	08323	99	08922	107	09650	143
06023	246	08362	106	08923	107	09662	143
06025	246	08363	106	08925	107	09665	143
06030	168	08365	106	08932	107	10001	198
06050	169	08396	101	08933	107	10002	200
06080	161	08397	101	08935	107	10008	200
06082	161	08398	101	08963	98	10009	200
06240	144	08399	101	08964	98	10011	209
06241	144	08403	103	08965	98	10013	204
08004	130	08405	103	08968	98	10017	200
08005	130	08409	103	08970	98	10018	198

Ref.	pag.	Ref.	pag.	Ref.	pag.	Ref.	pag.
10023	204	11022	210	20208	139	24051	235
10024	204	11035	210	20209	139	24052	235
10031	207	12040	210	21030	138	24053	235
10037	205	12041	210	21035	138	24054	235
10038	207	12043	210	21035_NG	139	24061	235
10039	207	12044	210	21036	138	24062	235
10051	203	12045	210	21235	139	24063	235
10055	205	12046	210	21236	139	24064	235
10058	204	12047	210	22040	137	24072	235
10059	204	12048	210	22071	140	24073	235
10061	202	12049	210	22091	140	24075	235
10064	207	12050	211	22110	140	24076	235
10067	206	12051	211	23080	133	24082	235
10072	203	12053	211	23085H	136	24083	235
10074	202	12072	211	23090	133	24085	235
10075	206	12091	211	23093	133	24086	235
10080	198	12092	211	23110	137	24092	235
10081	199	12110	201	23119	137	24093	235
10082	199	12111	201	23120	137	24102	235
10083	199	12113	201	23126	137	24103	235
10105	206	12120	210	23127	137	24122	238
10147	213	12121	210	23128	137	24123	238
10148	213	12122	210	23130	134	24124	238
10149	213	12123	210	23140	134	24151	237
10150	213	12145	201	23150	134	24152	237
10151	208	15030	138	23152	137	24153	237
10153	208	16010	138	23160	134	24154	237
10181	208	18004	130	23162	135	24156	237
10455	214	18005	130	23169	135	24158	237
10460	214	18006	131	23300	136	24159	237
10480	205	18010	128	24002	213	24160	237
10700	209	18012	128	24003	213	24176	237
10701	209	18019	129	24004	213	24177	237
10722	208	18020	128	24007	213	24300	234
10723	208	18030	128	24011	235	24301	234
10745	201	18070	131	24012	235	24303	234
10770	214	18080	131	24013	235	24320	234
10801	209	19010	128	24014	235	24321	234
10820	215	19040	132	24021	235	24322	234
10821	215	19043	132	24022	235	25010	237
10822	215	19050	132	24023	235	25011	237
10830	215	19060	132	24024	235	25012	237
10835	231	20070	138	24031	235	25013	237
10836	231	20106	138	24032	235	25015	237
10903	212	20107	138	24033	235	25017	237
10904	212	20108	138	24034	235	25018	237
10905	212	20109	138	24041	235	25019	237
10906	212	20109_NG	139	24042	235	25030	237
11020	210	20110	138	24043	235	25031	237
11021	210	20136	132	24044	235	25032	237

Ref.	pag.	Ref.	pag.	Ref.	pag.	Ref.	pag.
25033	237	25133	236	27071	242	28129	252
25035	237	25134	236	27072	242	28130	252
25037	237	25135	236	27073	242	28131	252
25038	237	25136	236	27075	242	28132	252
25039	237	25141	236	27076	242	28133	252
25050	237	25142	236	27078	242	28135	252
25051	237	25143	236	28021	252	28137	252
25052	237	25144	236	28022	252	28138	252
25053	237	25145	236	28023	252	28139	252
25055	237	25146	236	28024	252	28140	252
25057	237	25151	236	28025	252	28141	252
25058	237	25152	236	28027	252	28142	252
25059	237	25153	236	28028	252	28143	252
25060	237	25154	236	28029	252	28144	252
25070	237	25155	236	28030	252	28146	248
25071	237	25156	236	28031	252	28151	248
25072	237	25200	236	28032	252	28152	248
25073	237	25201	238	28050	229	28170	251
25075	237	25202	238	28051	229	28171	251
25077	237	25203	238	28052	229	28172	251
25078	237	25204	238	28053	229	28173	251
25079	237	25205	238	28054	229	28174	251
25084	237	25221	238	28055	229	28175	251
25091	237	25222	238	28056	229	28176	251
25092	237	25223	238	28057	229	28177	251
25095	237	25224	238	28060	229	28178	251
25096	236	25225	238	28090	251	28179	251
25097	237	25497	241	28091	251	29053	243
25098	237	25498	241	28092	251	29055	243
25099	237	25510	241	28093	251	29056	243
25101	236	25511	241	28094	251	29057	243
25102	236	25512	241	28095	251	29058	243
25103	236	25513	241	28096	251	29059	243
25104	236	25514	241	28101	251	29060	243
25105	236	25515	241	28102	251	29061	243
25106	236	25516	241	28103	251	29062	243
25111	236	26031	242	28104	251	29063	243
25112	236	26032	242	28105	251	29072	243
25113	236	26033	242	28106	251	29073	243
25114	236	26035	242	28115	251	29075	243
25115	236	26036	242	28116	251	29076	243
25116	236	26038	242	28117	251	29077	243
25121	236	27029	242	28118	251	29078	243
25122	236	27030	242	28119	251	29079	243
25123	236	27031	242	28120	251	29080	243
25124	236	27032	242	28121	251	29143	243
25125	236	27033	242	28122	251	29145	243
25126	236	27035	242	28124	251	29146	243
25131	236	27036	242	28125	251	29147	243
25132	236	27038	242	28128	252	29148	243

Ref.	pag.	Ref.	pag.	Ref.	pag.	Ref.	pag.
29149	243	29252	144	30101	250	32216X	159
29150	243	29253	144	30102	250	32218X	159
29151	243	29254	144	30103	250	32224	151
29152	243	29255	144	30110	250	32225	151
29153	243	29256	144	30111	250	32226	151
29162	243	29257	144	30112	250	32228	151
29163	243	29263	244	30113	250	32230	151
29165	243	29264	244	30120	250	32232	151
29166	243	29265	244	30121	250	32270	164
29167	243	29301	145	30122	250	32271	164
29168	243	29302	145	30123	250	32272	164
29169	243	29303	145	30130	250	32273	164
29170	243	29304	145	30131	250	32274	164
29182	244	29305	145	30132	250	32275	164
29183	244	29320	146	31021	160	32290	156
29184	244	29321	146	31024	160	32291	156
29185	244	29322	146	31025	160	32292	156
29186	244	29323	146	31062	158	32293	156
29187	244	29354	145	31063	158	32294	156
29188	244	29355	145	31064	158	32295	156
29189	244	29356	145	31065	158	32296	156
29190	244	29357	145	31066	158	32298	156
29191	244	29358	145	31072	158	32300	156
29192	244	29359	145	31073	158	32302	156
29193	244	29502	145	31074	158	32304	156
29194	244	29790	85	31075	158	32305	156
29195	244	29890	85	31076	158	32306	156
29196	244	29900	86	31078	158	32308	156
29197	244	29901	86	31080	158	32310	156
29198	244	29902	86	31084	157	32365	151
29199	244	29903	86	31085	157	32368	151
29200	244	29904	86	31086	157	32370	151
29210	244	29905	87	31088	157	32543	159
29219	146	29915	87	31090	157	32544	159
29220	146	30010	250	31094	157	32545	159
29221	146	30011	250	31095	157	32546	159
29222	146	30012	250	31096	157	32548	159
29232	144	30013	250	31098	157	32550	159
29233	144	30020	250	32163	158	32551	159
29234	144	30021	250	32164	158	32552	159
29235	144	30022	250	32165	158	32553	159
29236	144	30023	250	32166	158	32554	159
29237	144	30030	250	32168	158	32563	159
29240	144	30031	250	32170	158	32564	159
29241	144	30032	250	32204	158	32565	159
29242	144	30033	250	32205	158	32566	159
29243	144	30040	250	32206	158	32568	159
29244	144	30041	250	32208	158	32570	159
29245	144	30042	250	32210	158	32650	164
29247	144	30043	250	32214X	159	32651	164

Ref.	pag.	Ref.	pag.	Ref.	pag.	Ref.	pag.
32652	164	32855	155	33218	153	35101	216
32653	164	32858	155	33220	153	35102	216
32654	164	32860	155	33226	160	35103	216
32660	164	32920	162	33236	160	35104	216
32661	164	32937	151	33304	152	35105	216
32662	164	32939	152	33305	152	35129	217
32663	164	32941	153	33306	152	35134	217
32664	164	33000	161	33308	152	35135	217
32670	164	33001	161	33310	152	35136	217
32671	164	33031	160	33312	152	35140	217
32672	164	33032	160	33315	152	35142	217
32673	164	33080	161	33318	152	35143	217
32674	164	33081	161	33320	152	36030	142
32675	164	33082	161	33806	85	36500	142
32676	164	33083	161	33810	85	36511	142
32677	164	33084	161	34030	163	36512	142
32704	154	33130	152	34100	163	36513	142
32705	154	33134	152	34500	162	36514	142
32706	154	33135	152	34509	162	36540	142
32708	154	33136	152	34510	162	36541	142
32710	154	33138	152	34511	162	36542	142
32734	154	33140	152	34513	162	36543	142
32735	154	33141	152	34514	162	36550	143
32736	154	33142	152	34519	162	38028	109
32738	154	33145	152	34520	162	38029	109
32740	154	33150	152	34521	162	38030	109
32754	150	33164	153	34550	162	38031	109
32755	150	33165	153	34551	162	38032	109
32756	150	33166	153	35010	217	38033	109
32758	150	33168	153	35011	217	38143D	94
32804	155	33170	153	35015	217	38145D	94
32805	155	33172	153	35018	217	38148D	94
32806	155	33175	153	35020	216	38162	106
32808	155	33178	153	35021	216	38163	106
32810	155	33180	153	35022	216	38165	106
32834	151	33182	153	35023	216	38182	106
32835	151	33183	153	35024	216	38183	106
32836	151	33185	153	35041	216	38185	106
32837	151	33186	153	35042	216	38196	106
32838	151	33194	153	35043	216	38206	105
32839	151	33195	153	35070	217	38212	96
32840	151	33196	153	35071	217	38214	96
32841	151	33198	153	35078	217	38215	96
32842	151	33200	153	35080	216	38218	96
32844	155	33202	153	35081	216	38264	105
32845	155	33205	153	35082	216	38362	106
32846	155	33208	153	35083	216	38363	106
32848	155	33210	153	35084	216	38365	106
32850	155	33212	153	35085	216	38396	101
32852	155	33215	153	35100	216	38397	101

Ref.	pag.	Ref.	pag.	Ref.	pag.	Ref.	pag.
38398	101	38940	109	40014	124	42224	230
38399	101	38962	107	40015	124	42225	230
38402	99	39192	119	40016	124	43030	232
38404	99	39203V	117	40017	124	43031	232
38433	101	39207V	117	40023V	121	43032	232
38496	106	39213V	117	40025V	121	43034	232
38497	106	39217V	117	40027	121	43037	232
38503	101	39223	119	40029V	120	43049	233
38505	101	39225	119	40031	123	43051	233
38508	101	39238V	116	40033	123	43052	233
38510	101	39242V	114	40034	123	43053	233
38593	103	39243V	114	40035	123	43054	233
38595	103	39244V	115	40037	123	43055	233
38596	103	39261V	118	40053	123	43056	233
38597	97	39262V	118	40055	123	43057	233
38598	103	39270V	116	40057	123	43059	233
38599	103	39272V	117	40086	84	43060	233
38605	100	39273V	117	40090	84	43061	233
38643H	104	39274V	117	40091	84	43068	233
38645H	104	39275V	117	40113	122	43069	233
38646H	104	39277V	117	40115	122	43100	233
38647H	104	39330	118	40143	123	43101	233
38648H	104	39350	118	40223	122	43102	233
38653	104	39801	240	41010	226	43120	233
38654	104	39802	240	41017	228	43121	233
38655	104	39803	240	41018	228	43122	233
38656	104	39811	240	41019	226	43140	215
38658	104	39812	240	41020	226	43180	231
38660	104	39813	240	41025	226	43181	231
38736	102	39821	240	41026	226	44010	223
38751	108	39822	240	41027	227	44021	225
38754	108	39823	240	41028	227	44026	222
38761	108	39826	240	41052	227	44027	222
38764	108	39827	240	41053	227	44028	222
38771	108	39828	240	41080	228	44030	225
38774	108	39831	240	41085	228	44040	224
38892	107	39832	240	41090	227	44041	224
38893	107	39833	240	41150	228	44061	218
38895	107	39836	240	42010	229	44062	218
38910	241	39837	240	42020	229	44063	218
38911	241	39838	240	42030	229	44064	218
38912	107	39979	240	42032	229	44065	218
38913	107	39980	240	42040	229	44066	218
38915	107	39981	240	42110	229	44067	218
38922	107	39985	240	42120	229	44068	218
38923	107	39986	240	42130	229	44069	218
38925	107	39987	240	42140	229	44080	218
38932	107	40011	124	42204	230	44081	224
38933	107	40012	124	42205	230	44082	224
38935	107	40013	124	42223	230	44083	224

Ref.	pag.	Ref.	pag.	Ref.	pag.	Ref.	pag.
44084	224	44381	221	48058	247	49366	88
44085	224	45011	249	48059	247	49370	90
44086	224	45050	249	48066	247	49371	90
44087	224	45051	249	48068	247	49373	89
44088	224	45060	249	48069	247	49374	89
44090	224	45061	249	48071	212	49377	90
44091	224	45070	249	48072	212	49492	180
44095	218	45071	249	48073	212	49494	180
44096	218	45072	249	48074	212	49498	180
44098	222	46005	254	48075	247	49510	180
44099	222	46010	253	48076	247	49550	180
44101	223	46015	253	48077	247	49562	180
44102	223	46020	253	48078	247	49563	180
44103	223	46023	253	49012	170	49564	180
44104	223	46025	253	49014	168	49565	180
44106	223	46060	254	49016	168	49581	180
44107	223	46070	254	49017	168	49582	180
44111	222	48002	247	49018	171	50001M	189
44114	222	48003	247	49023	171	50002M	189
44115	222	48004	247	49024	169	50003M	189
44116	222	48005	247	49025	173	50004M	189
44117	222	48006	247	49030	168	50005M	189
44120	225	48007	247	49031	168	50006M	189
44122	219	48008	247	49035	170	50007M	189
44123	219	48009	247	49036	167	50009M	189
44124	219	48011	246	49048	171	50011	190
44130	219	48012	246	49049	172	50012	190
44202	221	48013	246	49050	169	50013	190
44203	221	48014	246	49051	169	50014	190
44204	221	48015	246	49052	173	50018M	190
44205	221	48016	246	49054	170	50040	185
44210	220	48017	246	49061	169	50041	185
44211	220	48021	246	49117	172	50042	185
44212	220	48022	246	49124	171	50043	185
44213	220	48023	246	49127	171	50045	186
44220	220	48024	246	49145	173	50047	186
44230	220	48025	246	49151	173	50049	186
44250	223	48026	246	49159	181	50050	191
44251	223	48027	246	49204	47	50051	191
44252	223	48031	246	49205	47	50070	191
44300	221	48032	246	49345	90	50071	191
44301	221	48033	246	49356	89	50072	191
44351	219	48034	246	49358	88	50100M	190
44352	219	48035	246	49359	88	50101M	190
44353	219	48036	246	49360	88	50102M	190
44354	219	48037	246	49361	88	50140	188
44371	219	48053	247	49362	88	50141	188
44372	219	48055	247	49363	88	50142	188
44373	219	48056	247	49364	89	50143	188
44374	219	48057	247	49365	88	50148	188

Ref.	pag.	Ref.	pag.	Ref.	pag.	Ref.	pag.
50150M	188	51070	181	60221	193	60500	83
50151M	188	51080	183	60222	193	60502	83
50152M	188	51083	184	60223	193	60559	41
50153M	188	51093	184	60271	81	60560	41
50181	187	51094	184	60274	80	60562	38
50182	187	51098	184	60282	78	60565	42
50183	187	51105	184	60286	81	60566	42
50184	187	51150	185	60290	79	60571	66
50185	187	51151	185	60291	79	60574	43
50186	187	60010	91	60294	81	60581	43
50220M	189	60011	91	60296	163	60582	43
50221M	189	60023	91	60300	254	60584	44
50222M	189	60024	91	60304	254	60585	43
50350M	188	60031	91	60305	254	60586	43
50351M	188	60090	47	60350	192	60587	43
50352M	188	60095	194	60352	192	60588	43
50353M	188	60096	194	60353	192	60590	44
50390	182	60097	195	60354	192	60596	44
50392	182	60101	194	60355	192	60598	44
50393	182	60110	194	60363	192	60611	33
50500	174	60112	194	60364	192	60621	41
50501	174	60113	195	60390	193	60712	41
50503	174	60114	194	60391	193	60713	39
50505	174	60120	191	60393	70	60714M	38
50508	174	60122	191	60394	69	60719	20
50509	174	60123	194	60395	70	60719BM	19
50518	175	60126	194	60396	71	60724	34/35
50519	175	60127	195	60397	71	60727	34
50520	174	60128	195	60398	71	60728	40
50521	174	60132	191	60399	71	60735	36
50530	175	60133	195	60400	71	60736	34
50535	175	60138	195	60401	71	60738	39
50540	175	60139	195	60405	75	60741	34
50541	176	60140	195	60408	74	60744	36
50543	176	60141	195	60423	75	60746	40
50545	176	60190	193	60424	68	60747	40
51010	181	60191	193	60425	76	60748	34
51011	181	60192	193	60435	67	60749	34
51012	181	60193	193	60436	67	60804	9
51013	181	60194	193	60438	67	60805	10
51020	181	60195	193	60453	83	60807	18
51040	182	60196	193	60458	82	60810	39
51041	182	60197	193	60459	82	60811	34
51042	182	60198	193	60464	83	60814BR	15
51050N	181	60201	192	60466	45	60815	39
51051N	181	60202	192	60467	45	60816	39
51052N	181	60205	192	60480	45	60819	40
51053N	181	60210	77	60495	42	60820	36
51054N	181	60216	77	60498	42	60821	22
51060	181	60220	193	60498D	43	60822	23

Ref.	pag.	Ref.	pag.	Ref.	pag.	Ref.	pag.
60830	38	61351	27	68132	196	70146	255
60831	35	61352	25	68135	196	70147	255
60832	35	61353	27	68137	196	70152	255
60833	32	61354	27	68250	196	70154	255
60835	35	61355	21	68255	196	70155	255
60836	34	61360	11	68753	179	70156	255
60837	38	61365	11	68775	179	70157	255
60838	38	61370	14	68776	179	70158	255
60840	46	61375	14	68777	179	70159	255
60866	39	61380	15	68781	177	70200	231
60867	40	61400M	16	68782	177	70206	231
60871	32	61405M	17	68783	177	70300	239
60872	32	61410M	16	69097	195	70301	239
60873	32	61415M	17	69098	195	70301V	239
61007	63	61420	12	69160	196	70800	73
61008	61	61430	12	69170	196	70801	73
61010	65	61435	13	69180	196	70803	72
61012	65	61440	37	69181	196	70804	72
61014	62	61445	40	69592	178	72001	245
61015	64	61450	40	69593	178	72002	245
61017	61	61451	40	69594	178	72003	245
61023	64	61452	39	69595	178	72005	245
61029	62	61453	39	69598	178	72100	173
61031	63	61454	39	69601	178	72101	173
61060	59	61530	78	69638	196	72105	173
61100	59	61930	66	69650	143	72600	178
61109	52	65000	257	69665	143	86015	185
61110	52	65002	257	69997	141	89086	134
61114	53	65003	257	70000	256	89090	133
61120	54	65004	257	70003	257	89091	133
61130	55	65007	258	70005	257	89092	134
61155	55	65008	258	70023	80	89266	45
61186	56	65020	258	70029	80	89267	45
61190	57	65021	258	70099	69	89268	45
61240	58	65022	258	70102	255	89295	60
61260	58	65024	258	70104	255	89296	60
61300	8	65030	258	70105	255	89780	108
61319	35	65031	258	70106	255	98052	156
61324	36	65035	258	70107	255	98056	152
61326	35	65043	256	70108	255	98060	110
61328	35	65044	256	70109	255	98061	110
61329	35	65055	256	70110	76	EXPO AUTOL	29
61331	34	65056	256	70133	255	EXPO FLASH	60
61332	34	65057	256	70134	255	EXPO FLESS	110
61335	38	65058	256	70135	255	EXPO TELEFIX	91
61340	37	65060	256	70136	255	TOWER	111
61342	37	65061	256	70137	255		
61345	28	65110	257	70143	255		
61349	26	65112	257	70144	255		
61350	24	68130	196	70145	255		

A series of horizontal lines for writing, starting below the red ruler line and extending to the bottom of the page.

A series of horizontal lines for writing notes, spaced evenly down the page.

A

ACCESSORI LASER	pag.	30
ACCESSORI PER EDILIZIA	pag.	196
ALESAMETRI	pag.	229
AUTOLIVELLI LASER	pag.	6

B

BASI MAGNETICHE	pag.	253
-----------------	------	-----

C

CALIBRI	pag.	197
COMPARATORI	pag.	226
COMPASSI	pag.	246
CONTAFILI E LENTI	pag.	180
CONTATORI E CONTACOLPI	pag.	256
CORDE E COLORANTI	pag.	193
CUTTER	pag.	165

D

DISTANZIOMETRI LASER	pag.	48
----------------------	------	----

F

FESSURIMETRI	pag.	84
FINGERSAFE	pag.	141
FLESSOMETRI PROFESSIONALI	pag.	92
FORBICI E CESOIE	pag.	177

G

GEODESIA	pag.	45
GESSI, PASTELLI E MATITE	pag.	181
GONIOMETRI	pag.	142

L

LIVELLE PER EDILIZIA	pag.	147
LIVELLE PRECISIONE	pag.	250

M

MARCATORI SPRAY E MARCATORI	pag.	187
METRI A STECCA E PER SARTO	pag.	125
MICROMETRI	pag.	218
MISURATORI	pag.	78
MISURATORI D'ANGOLO	pag.	85
MISURATORI DI SPESSORE	pag.	231
MISURATORI DUREZZA, SCLEROMETRO	pag.	77
MISURATORI STRADALI	pag.	82

P

PALINE	pag.	91
PIANI RISCONTRO	pag.	251
PIOMBI	pag.	192
PRISMI - GUARDAPIANO	pag.	252
PROFILOMETRI	pag.	245
PUNTE A TRACCIARE	pag.	248
PUNZONI	pag.	255

R

RIGHE - NASTRI - DIAMETROMETRI	pag.	234
RIGHE E SQUADRE PER VETRAI	pag.	175
ROTELLE	pag.	112

S

SQUADRE	pag.	143
SQUADRE PRECISIONE	pag.	243
STAGGIE	pag.	164
SUPPORTI	pag.	254

T

TELEFIX	pag.	88
TERMOCAMERE	pag.	67
TRACCIATORI	pag.	194
TREPPIEDI	pag.	42
TRUSCHINI	pag.	249

MADE TO MEASURE
MADE FOR MEASURE
MADE FOR YOU

CG21-IT-N



METRICA

Metrica S.p.A. - Italy
Via Grandi, 18 - 20097 San Donato

METRICA.IT

FOLLOW US ON INSTAGRAM **@METRICA.IT**